



COMISSÃO PERMANENTE DE LICITAÇÃO

Concorrência Eletrônica nº 005/2024-SEINFRA

UNIDADE ADMINISTRATIVA:

SECRETARIA DE INFRAESTRUTURA E SERVIÇOS PÚBLICOS

FUNDAMENTO LEGAL: LEI FEDERAL Nº Lei 14.133/2021 e outras normas aplicáveis ao objeto deste certame

OBJETO: CONTRATAÇÃO DE EMPRESA ESPECIALIZADA PARA EXECUÇÃO DOS SERVIÇOS DE RECUPERAÇÃO DE ESTRADAS VICINAIS NO MUNICÍPIO DE GUARACIABA DO NORTE-CE. CONFORME PT 1086270-03.

PASTA 06 / _____



10/00 13 00/00

10/00

10/00

10/00

10/00

10/00



Capítulo de Projeto

Projeto

10/00 13 00/00

10/00 13 00/00

10/00 13 00/00

10/00
10/00
10/00
10/00
10/00

10/00

10/00

10/00

10/00

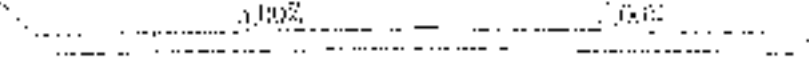

Capítulo de Projeto

Projeto

10/00 13 00/00



PREFEITURA MUNICIPAL DE GUARACIABA DO NORTE
RECUPERAÇÃO DE ESTRADAS VICINAIS NO MUNICÍPIO DE GUARACIABA DO NORTE-CE - PT 1386070-02

SEÇÃO DE PROJETO DA VIA COM LARGURA 6,00M

MATERIAL: ...
PROJETO: ...

1 / 01

10/00

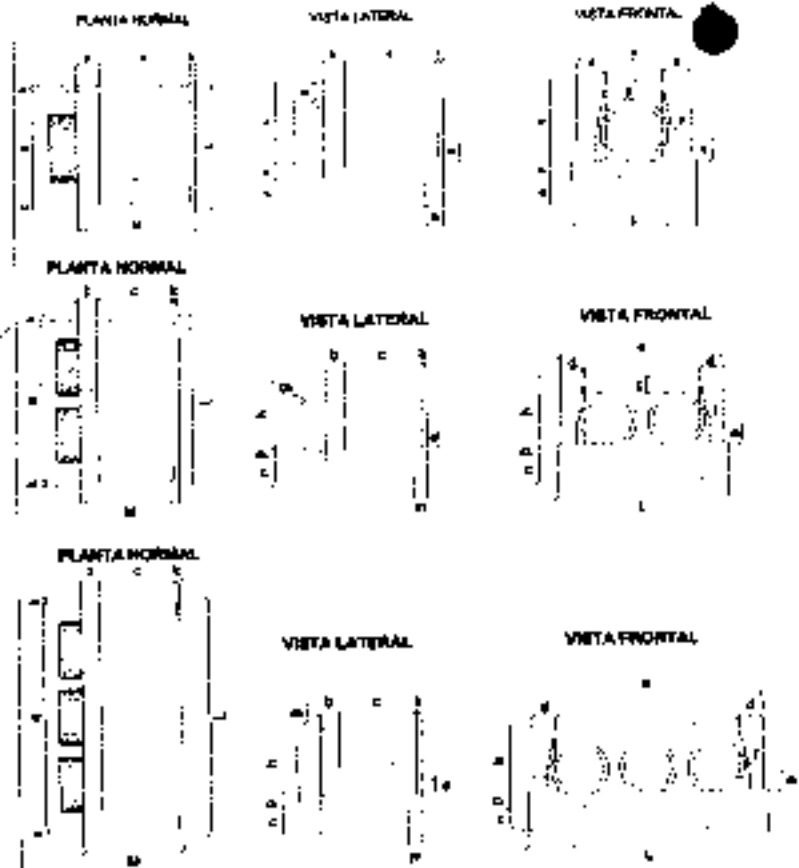

DIMENSÕES E CONDIÇÕES MÉDICAS PARA UMA LINHA DE

BUEIRO SIMPLES TUBULAR φ = 80

TIPO DE TUBO	10	15	20	25	30	35	40	45	50	55	60	65	70	75	80
COMPRIMENTO	10	15	20	25	30	35	40	45	50	55	60	65	70	75	80
DIÂMETRO	80	80	80	80	80	80	80	80	80	80	80	80	80	80	80
ESPESURA	10	10	10	10	10	10	10	10	10	10	10	10	10	10	10
QUANTIDADE	10	10	10	10	10	10	10	10	10	10	10	10	10	10	10

DIMENSÕES E CONDIÇÕES MÉDICAS PARA UMA LINHA DE

BUEIRO DUPLO TUBULAR φ = 80

TIPO DE TUBO	10	15	20	25	30	35	40	45	50	55	60	65	70	75	80
COMPRIMENTO	10	15	20	25	30	35	40	45	50	55	60	65	70	75	80
DIÂMETRO	80	80	80	80	80	80	80	80	80	80	80	80	80	80	80
ESPESURA	10	10	10	10	10	10	10	10	10	10	10	10	10	10	10
QUANTIDADE	10	10	10	10	10	10	10	10	10	10	10	10	10	10	10

DIMENSÕES E CONDIÇÕES MÉDICAS PARA UMA LINHA DE

BUEIRO TRIPLO TUBULAR φ = 100

TIPO DE TUBO	10	15	20	25	30	35	40	45	50	55	60	65	70	75	80
COMPRIMENTO	10	15	20	25	30	35	40	45	50	55	60	65	70	75	80
DIÂMETRO	100	100	100	100	100	100	100	100	100	100	100	100	100	100	100
ESPESURA	10	10	10	10	10	10	10	10	10	10	10	10	10	10	10
QUANTIDADE	10	10	10	10	10	10	10	10	10	10	10	10	10	10	10



INSTITUTO PARANAENSE DE SANEAMENTO S.A. - IPA
 REPRODUÇÃO DE PROJETOS E PLANOS DE SANEAMENTO
 CONDIÇÃO: 100% - 100%
 PROJETO TUBERIAS DE SANEAMENTO



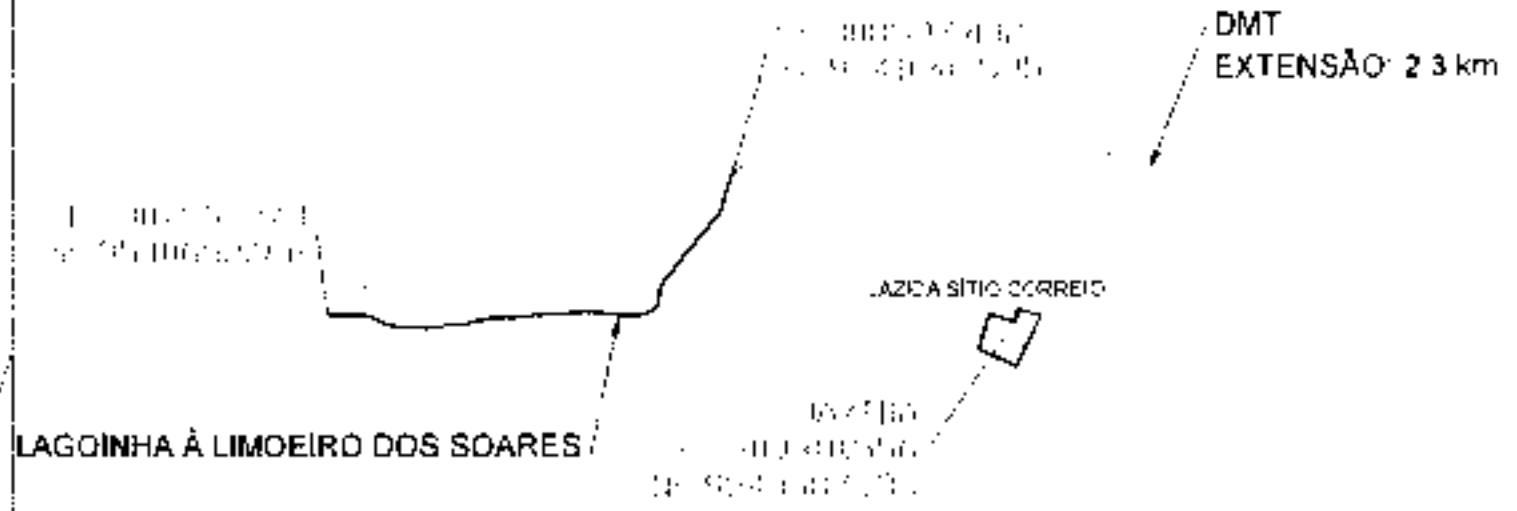

LEGENDA

DMT-11

DMT-12

DMT-13

DMT-14



		COMISSÃO DE LICITAÇÃO RUBRICA	
PROCESSO Nº 001/2011			
OBJETO: LICITAÇÃO Nº 001/2011			
DATA DE ABERTURA: 15/05/2011			
LOCAL: RUA DE SÃO CARLOS, Nº 100, RUBIATA, MATO GROSSO DO SUL			
HORA: 14h00min			
VALOR: R\$ 1.000,00			
VALOR DE LICITAÇÃO: R\$ 1.000,00			
VALOR DE LICITAÇÃO: R\$ 1.000,00			
VALOR DE LICITAÇÃO: R\$ 1.000,00			
VALOR DE LICITAÇÃO: R\$ 1.000,00			
VALOR DE LICITAÇÃO: R\$ 1.000,00			

AZIDA SÍTIO CORRÊIO

6/116
401/1/1/1/1
16/1/1/1/1/1/1



16/1/1/1/1/1/1/1
N 11/1/1/1/1/1/1



TRECHO RAMAL CORREIOS -
SÍTIO SÃO SILVESTRE

16/1/1/1/1/1/1/1
N 11/1/1/1/1/1/1

OMT
EXTENSÃO: 1,1 km

LEGENDA

- (Solid line) —
- (Dashed line) —
- (Dotted line) —
- (Dash-dot line) —

		MUNICÍPIO DE SÃO PAULO	
SECRETARIA DE TRANSPORTES		DEPARTAMENTO DE FERROVIAS	
RUA ...		Cidade de São Paulo, SP	
Data: ...		Folha: ...	
Assinatura: ...		Carimbo: ...	



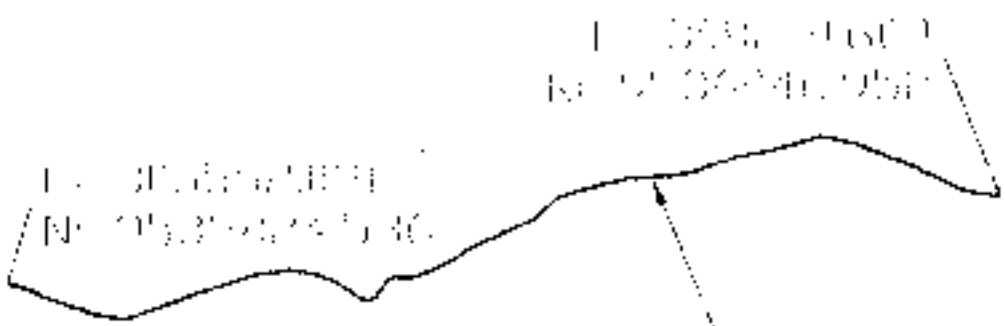

TRECHO CRUZ DAS ALMAS

DMT
EXTENSÃO: 3,04 km

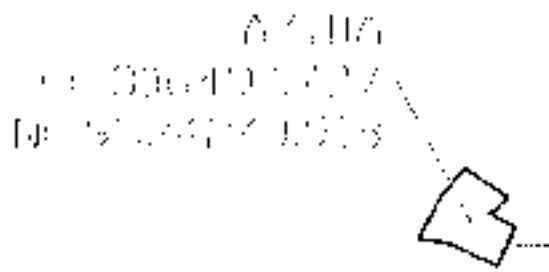

LEGENDA

- TRECHO
- DMT
- DEMÁS TRENCHOS
- LAGUNA

<p>MUNICÍPIO DE CRUZ DAS ALMAS</p> <p>SECRETARIA MUNICIPAL DE OBRAS, SANEAMENTO E TRANSPORTES</p> <p>DEPARTAMENTO DE LICITAÇÃO E ADMINISTRAÇÃO DE MATERIAIS DE CONSTRUÇÃO</p> <p>TRECHO 15 - CRUZ DAS ALMAS</p>			
Item	Descrição	Quantidade	Valor
01
02
03
04
05

TRECHO SÍTIO BANANEIRA / SÍTIO LIMOEIRO DOS SOARES

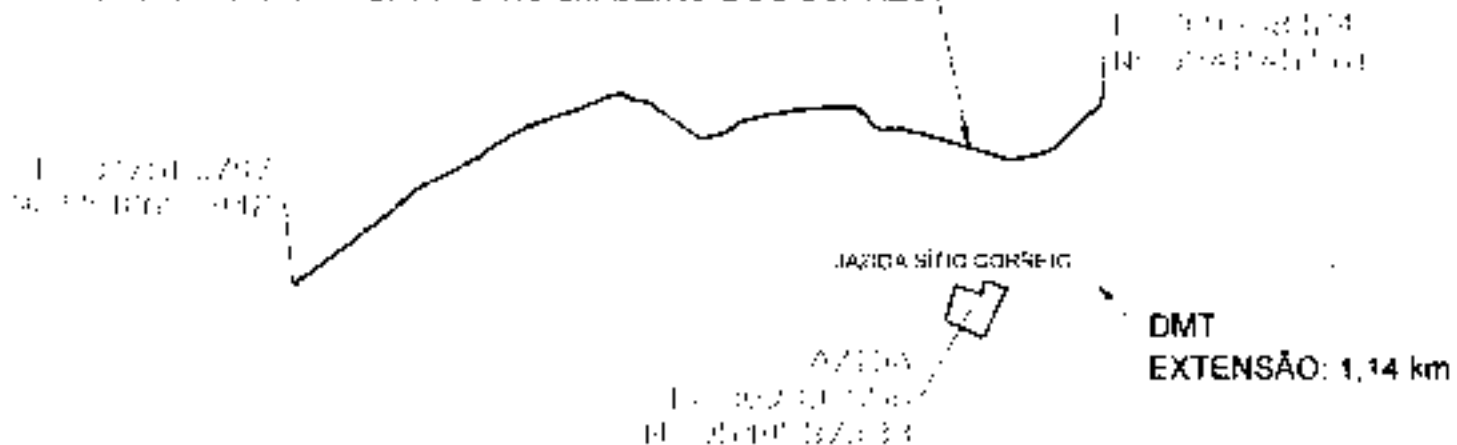

1:2.500
 199240
 201402190401
 1/1/14



<p>PROPOSTA Nº</p> <p>DATA DE RECEBIMENTO</p> <p>VALOR TOTAL DA PROPOSTA</p>	
	<p>EMPRESA: []</p> <p>INSCRIÇÃO ESTADUAL: []</p> <p>INSCRIÇÃO MUNICIPAL: []</p> <p>INSCRIÇÃO FEDERAL: []</p> <p>CPF: []</p> <p>RG: []</p> <p>PROPOSTA Nº: []</p> <p>DATA DE RECEBIMENTO: []</p> <p>VALOR TOTAL DA PROPOSTA: []</p> <p>VALOR UNITÁRIO: []</p> <p>VALOR TOTAL DA OBRERA: []</p> <p>VALOR TOTAL DA OBRERA (com impostos): []</p> <p>VALOR TOTAL DA OBRERA (sem impostos): []</p> <p>VALOR TOTAL DA OBRERA (com impostos e frete): []</p> <p>VALOR TOTAL DA OBRERA (sem impostos e frete): []</p> <p>VALOR TOTAL DA OBRERA (com impostos e frete e seguro): []</p> <p>VALOR TOTAL DA OBRERA (sem impostos e frete e seguro): []</p> <p>VALOR TOTAL DA OBRERA (com impostos e frete e seguro e frete): []</p> <p>VALOR TOTAL DA OBRERA (sem impostos e frete e seguro e frete): []</p>
	<p>VALOR TOTAL DA OBRERA (com impostos e frete e seguro e frete): []</p> <p>VALOR TOTAL DA OBRERA (sem impostos e frete e seguro e frete): []</p> <p>VALOR TOTAL DA OBRERA (com impostos e frete e seguro e frete e frete): []</p> <p>VALOR TOTAL DA OBRERA (sem impostos e frete e seguro e frete e frete): []</p>

JAZIDA SÍTIO CORREIO
E. 10.000.000
N. 10.000.000



E. 10.000.000
N. 10.000.000

DMT
EXTENSÃO: 1,1 km

TRECHO SÍTIO CORREIOS -
SÍTIO SANTA IZABEL

E. 10.000.000
N. 10.000.000

LEGENDA
----- TRONCO
--- GR
--- SÍTIO
--- RUA



MUNICÍPIO DE SANTA IZABEL	
SECRETARIA MUNICIPAL DE PLANEJAMENTO E ADMINISTRAÇÃO	
DEPARTAMENTO DE LICITAÇÃO	
PROCESSO Nº 001/2014	
OBJETO: CONTRATAÇÃO DE SERVIÇOS DE MANUTENÇÃO E REPARAÇÃO DE VEÍCULOS	
EMPRESA: []	
VALOR: []	
DATA: []	
ASSINATURA: []	
CARGO: []	

JAZIDA SÍTIO CORREIO

1 - 30.000.0000
N - 10.000.0000

1 - 30.000.0000
N - 10.000.0000



TRECHO SÍTIO CORSA -
SÍTIO SANTA IZABEL

1 - 30.000.0000
N - 10.000.0000

DMT
EXTENSÃO 840m

LEGENDA

- TRECHO
- DMT
- SÍTIO
- JAZIDA

			
<p>SECRETARIA MUNICIPAL DE PLANEJAMENTO E FINANÇAS</p>			
<p>SECRETARIA MUNICIPAL DE OBRAS, SANEAMENTO E TRANSPORTES</p>			
<p>SECRETARIA MUNICIPAL DE EDUCAÇÃO</p>			
<p>SECRETARIA MUNICIPAL DE SAÚDE</p>			
<p>SECRETARIA MUNICIPAL DE CULTURA, TURISMO E RECREAÇÃO</p>			
<p>SECRETARIA MUNICIPAL DE AGRICULTURA, PASTORAL, PECUÁRIA E ZOOPECUÁRIA</p>			
<p>SECRETARIA MUNICIPAL DE MEIO AMBIENTE</p>			
<p>SECRETARIA MUNICIPAL DE DEFESA CONSUMIDOR</p>			
<p>SECRETARIA MUNICIPAL DE ASSISTÊNCIA SOCIAL</p>			
<p>SECRETARIA MUNICIPAL DE COOPERAÇÃO COMUNITÁRIA</p>			
<p>SECRETARIA MUNICIPAL DE COMERCIO E INDUSTRIA</p>			
<p>SECRETARIA MUNICIPAL DE CULTURA DEBATE</p>			
<p>SECRETARIA MUNICIPAL DE CULTURA DEBATE</p>			
<p>SECRETARIA MUNICIPAL DE CULTURA DEBATE</p>			
<p>SECRETARIA MUNICIPAL DE CULTURA DEBATE</p>			



TRECHO SÍTIO PARAÍSO
SÍTIO EXTREMA - TRECHO 01

1. 000 000 000 000
N 00 00 00 00 00

DMT
EXTENSÃO: 3,14 km

1. 000 000 000 000
N 00 00 00 00 00



LEGENDA

- TRECHO
- TAV
- DENJAS TRECHOS
- LADDA

<p>SECRETARIA MUNICIPAL DE OBRAS E TRANSPORTES</p>		<p>SECRETARIA MUNICIPAL DE OBRAS E TRANSPORTES</p>	
<p>TRECHO 01 - SÍTIO PARAÍSO SÍTIO EXTREMA - TRECHO 01</p>			
<p>PROJETO</p>	<p>PROJETO</p>	<p>PROJETO</p>	<p>PROJETO</p>
<p>PROJETO</p>	<p>PROJETO</p>	<p>PROJETO</p>	<p>PROJETO</p>
<p>PROJETO</p>	<p>PROJETO</p>	<p>PROJETO</p>	<p>PROJETO</p>
<p>PROJETO</p>	<p>PROJETO</p>	<p>PROJETO</p>	<p>PROJETO</p>

1. 2000/0000
2. 1000/0000

1. 2000/0000
2. 1000/0000

TRECHO SÍTIO PASSAGEM DAS PEDRAS.

DMT
EXTENSÃO: 5,06 km

1. 2000/0000
2. 1000/0000
3. 1000/0000

LEGENDA
----- TRILHA
--- CANAL
--- RUA
--- RIBEIRO

MUNICÍPIO DE	
ESTADO DO	
CADERNETO Nº	
FOLHA Nº	
Escala: 1:50.000	
TÍTULO: SÍTIO PASSAGEM DAS PEDRAS	
PROPOSTA Nº	
DATA: 10/05/2000	
AUTOR: [Illegible]	
PROJETADE: [Illegible]	
APROVADO: [Illegible]	
DATA: [Illegible]	
LOCAL: [Illegible]	
MUNICÍPIO: [Illegible]	
ESTADO: [Illegible]	
CADERNETO Nº	
FOLHA Nº	
Escala: 1:50.000	
TÍTULO: SÍTIO PASSAGEM DAS PEDRAS	
PROPOSTA Nº	
DATA: 10/05/2000	
AUTOR: [Illegible]	
PROJETADE: [Illegible]	
APROVADO: [Illegible]	
DATA: [Illegible]	
LOCAL: [Illegible]	
MUNICÍPIO: [Illegible]	
ESTADO: [Illegible]	



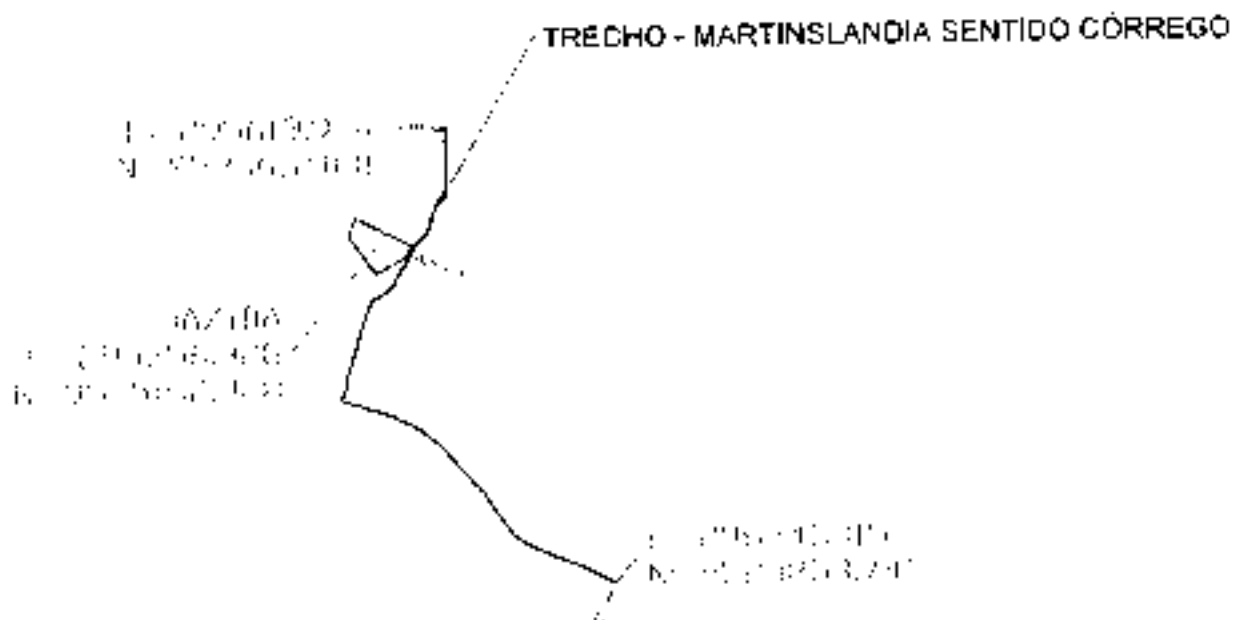

RECEBO
 RPT
 DEMONSTRATIVO
 NOTA

Nº _____

 MUNICÍPIO DE MARTINÓPOLIS
 RUA _____ Nº _____
 CEP _____

DATA	_____	_____
NOME	_____	_____
ENDEREÇO	_____	_____
CIDADE	_____	_____
UF	_____	_____
CEP	_____	_____



1:20000
N 113 04 113 04

SÍTIO CURRALINHO - TRECHO 02

1:20000
N 113 04 113 04

DMT
EXTENSÃO 4 16 km

JAZIDA SÍTIO LIMOEIRO - 01

JAZIDA
1:20000
N 113 04 113 04

ENTRADA

COMISSÃO DE LICITAÇÃO
 HUBRICA

LB
 LICITAÇÃO

_____ _____ _____ _____ _____	_____ _____ _____ _____ _____
---	---

1. 26/11/00
 2. 26/11/00
 3. 26/11/00



DMT
 EXTENSÃO
 3,48km

1. 26/11/00
 2. 26/11/00

TRECHO - ESPINHOS I

1. 26/11/00
 2. 26/11/00

LOCALIDADE
 TRAFEGO
 DMT
 DIMENSÃO
 DATA

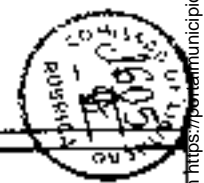

	Nome do Empreiteiro	
	Nome do Responsável	
Data de Emissão	Data de Validade	Assinatura
Nº de Emissão	Nº de Validade	Assinatura
Data de Emissão	Data de Validade	Assinatura

DMT
EXTENSÃO 2,77 km

1. 0248E-A8B3AD7E-100324D15E6F5F59C7
2. 0248E-A8B3AD7E-100324D15E6F5F59C7



0248E-A8B3AD7E-100324D15E6F5F59C7

TRECHO SÍTIO GUARANI / SÍTIO PALMEIRA

0248E-A8B3AD7E-100324D15E6F5F59C7

0248E-A8B3AD7E-100324D15E6F5F59C7

TRECHO 1
DMT
EXTENSÃO 2,77 km
0248E-A8B3AD7E-100324D15E6F5F59C7



0248E-A8B3AD7E-100324D15E6F5F59C7	0248E-A8B3AD7E-100324D15E6F5F59C7
0248E-A8B3AD7E-100324D15E6F5F59C7	0248E-A8B3AD7E-100324D15E6F5F59C7
0248E-A8B3AD7E-100324D15E6F5F59C7	0248E-A8B3AD7E-100324D15E6F5F59C7
0248E-A8B3AD7E-100324D15E6F5F59C7	0248E-A8B3AD7E-100324D15E6F5F59C7
0248E-A8B3AD7E-100324D15E6F5F59C7	0248E-A8B3AD7E-100324D15E6F5F59C7

0248E-A8B3AD7E-100324D15E6F5F59C7

100014 011
N 100013 000

DRECHO LINDEIRO DOS ROPPEUS - DESCRIBTA

DNT
EXTENSÃO 11.40

100014 011
N 100013 000

DA DA
MUNICÍPIO DE
B. M. S. M. S.

C. C. C. M. S.

PRIMEIRO
SEGUNDO
TERCEIRO
QUARTO



N.º 100014 011		
N.º 100013 000		
DNT EXTENSÃO 11.40		
DA DA		
MUNICÍPIO DE		
B. M. S. M. S.		
COMISSÃO DE FIDEJUSSÃO RUBRICA		
[Signature]		
[Date]		
[Other fields]		

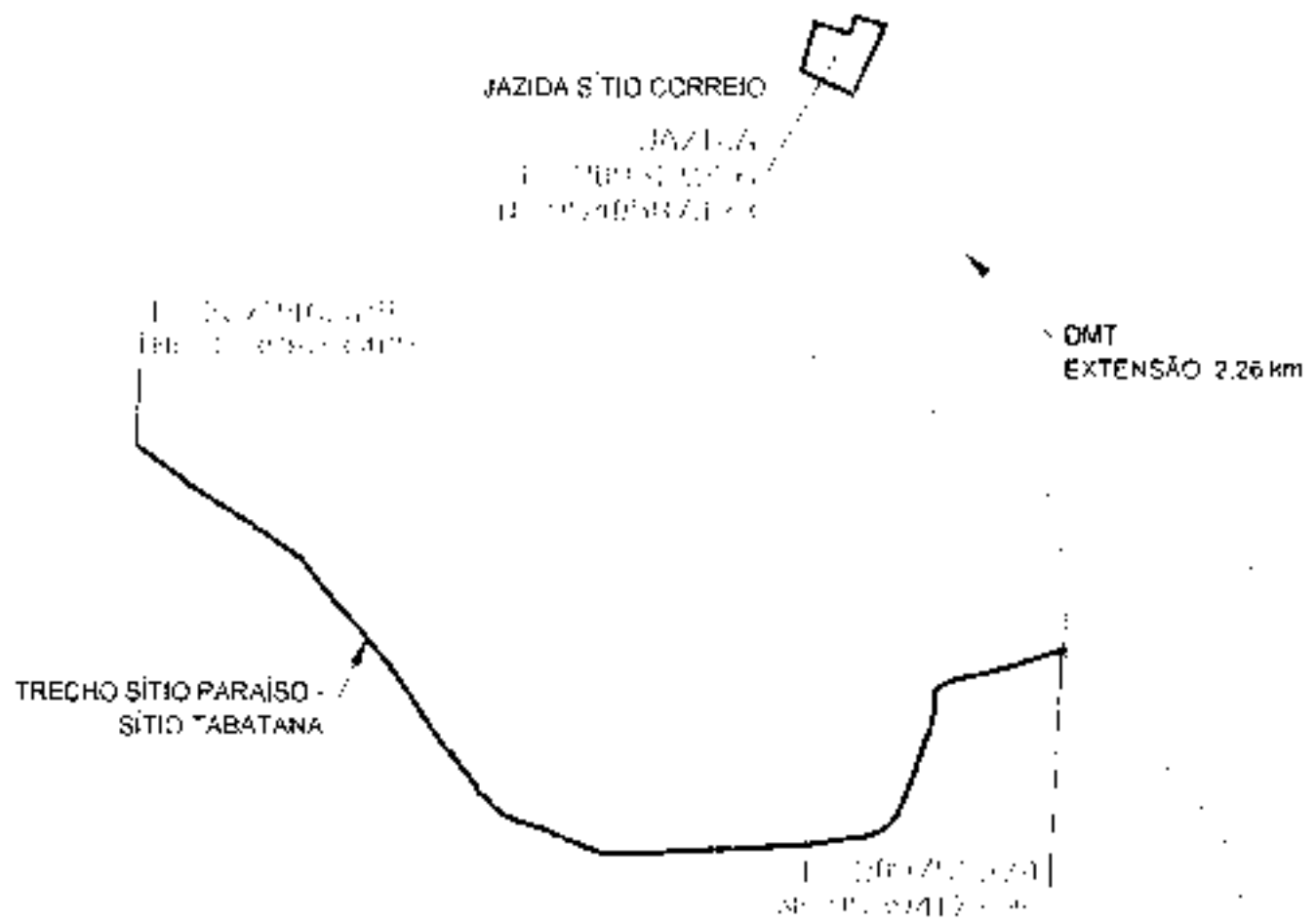

LOCALIDADE

PROVINCIA

MUNICÍPIO

COMISSÃO RÚBRICA

	Nº DE LICENCIAMENTO / Nº DE LICENÇA: 1.428
	DATA DE EMISSÃO: 27/06/2017
VALOR DO IMPOSTO: R\$ 1.428,00	
VALOR DO IPTU: R\$ 1.428,00	
VALOR DO ITCM: R\$ 1.428,00	
VALOR DO ITR: R\$ 1.428,00	
VALOR DO IPI: R\$ 1.428,00	
VALOR DO IPI (SOMADO): R\$ 1.428,00	
VALOR DO IPI (SOMADO): R\$ 1.428,00	
VALOR DO IPI (SOMADO): R\$ 1.428,00	

LA 115
LA 116
LA 117

DMT
EXTENSÃO
3,75km

LA 118
LA 119

TRECHO - PIQUE MAGRO

LEGENDA

- LA 115
- LA 116
- LA 117
- LA 118
- LA 119



EMPRESA	
RUA	
Cidade	
Estado	
CEP	
Inscrição Estadual	
Inscrição Municipal	
CNPJ	
Data de Emissão	
Valor	
Assinatura	
Carimbo	



DMT
EXTENSÃO. 4,98 km

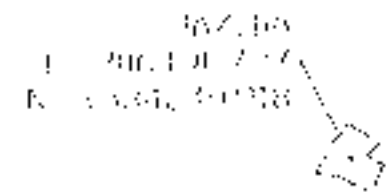

PROJETO
PROPOSTA
PROJETO

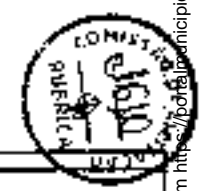

<p>SECRETARIA MUNICIPAL DE OBRAS E SERVIÇOS PÚBLICOS</p>	
<p>PROJETO DE LICITAÇÃO Nº 001/2010</p>	
<p>OBJETO: OBRAS DE RECONSTRUÇÃO DE PAVIMENTO DE CIMENTO-AMASSADO EM VARIAS RUAIS DO BARRIO SÃO FELIX, N.º 100324D15E66E5E59CZ</p>	
<p>EMPRESA LICITADA: [Nome da Empresa]</p>	
<p>VALOR DA OBRAS: [Valor]</p>	
<p>DATA DA LICITAÇÃO: [Data]</p>	
<p>ASSINATURA DO RESPONSÁVEL: [Assinatura]</p>	

TRECHO SÍTIO SÃO JOSÉ

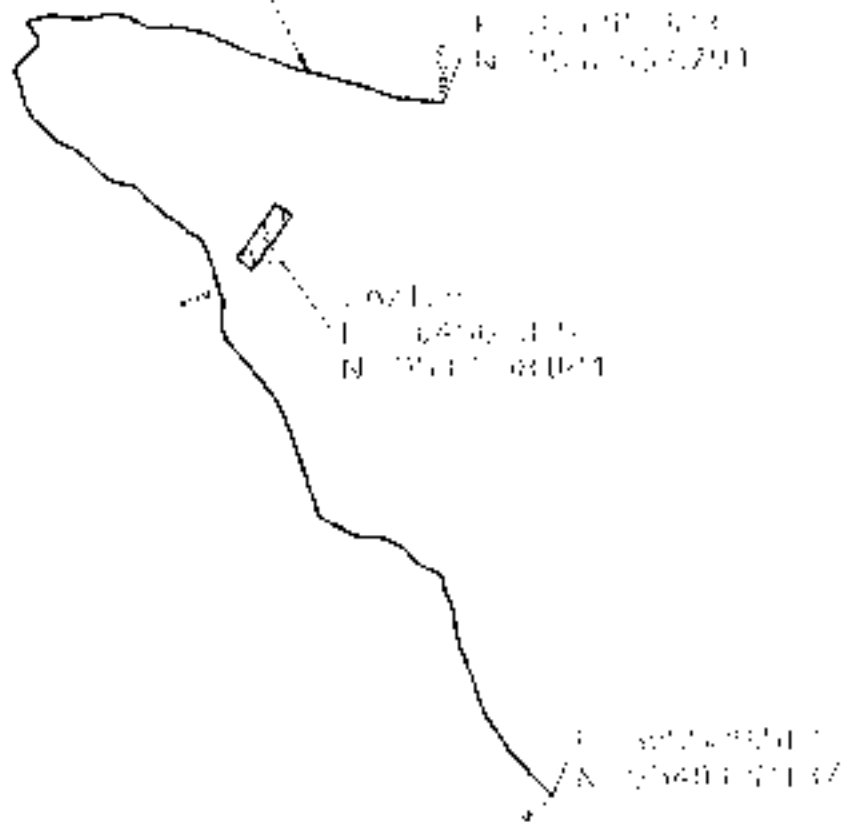

LEGENDA
----- PLOT
--- PLOT
----- PLOT
----- PLOT



	MUNICÍPIO DE SÃO JOSÉ DO BONFIM - PE	
	SECRETARIA DE ADMINISTRAÇÃO	
Nº 000/2017		
SÃO JOSÉ DO BONFIM - PE, 15 DE ABRIL DE 2017.		
Nome	_____	_____
Assinatura	_____	_____
Carimbo	_____	_____

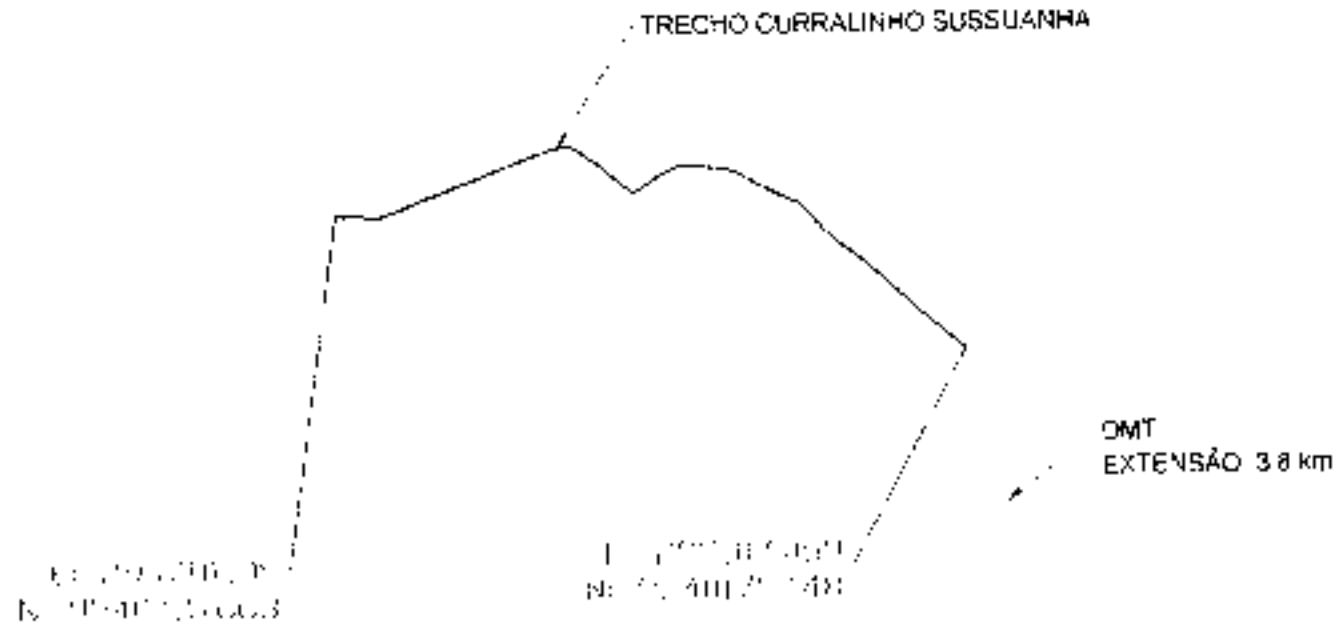

TRECHO CURRALINHO SUSSUANHA

OMT
EXTENSÃO 3,8 km

L. 1.000,00 m²
N. 1.400,00 m²

L. 1.000,00 m
N. 1.400,00 m

 L. 1.000,00 m²
 N. 1.400,00 m²

JAZIDA SÍTIO LIMOEIRO - 02

_____ TRECHO
 _____ OMT
 _____ EXTENSÃO 3,8 km

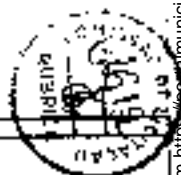



_____	_____	_____
_____	_____	_____
_____	_____	_____
_____	_____	_____
_____	_____	_____

TRECHO VÁRZEA DOS ESPINHOS / VÁRZEA REDONDA

PROPOSTA Nº 001/2014
Nº 001/2014 3.417

DMT
EXTENSÃO 1,7 km

ACR
PROPOSTA Nº 001/2014
Nº 001/2014 3.417

PROPOSTA Nº 001/2014
Nº 001/2014 3.417

PROPOSTA Nº 001/2014
Nº 001/2014 3.417

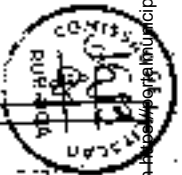

	MUNICÍPIO DE PIRAQUARA	
	SECRETARIA MUNICIPAL DE PLANEJAMENTO E FINANÇAS	
PROCESSO Nº 001/2014		
PROPOSTA Nº 001/2014		
Nº 001/2014 3.417		
VALOR DA PROPOSTA: R\$ 1.700,00		
DATA DE RECEBIMENTO: 10/01/2014		
LOCAL: PIRAQUARA, PARANÁ		

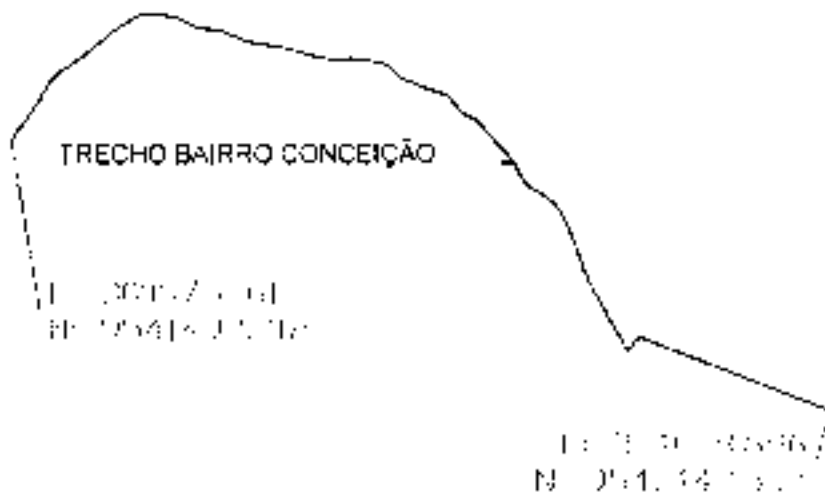

10/100
1000/1000
1000/1000

DMT
EXTENSÃO 2,4 km

LEGENDA

— DRENHO

— JMT

— TRAVESSIA

— LOMA



	Nº 1000/1000 R. 1000/1000	Nº 1000/1000 R. 1000/1000
	Nº 1000/1000 R. 1000/1000	Nº 1000/1000 R. 1000/1000
Nº 1000/1000 R. 1000/1000	Nº 1000/1000 R. 1000/1000	Nº 1000/1000 R. 1000/1000
Nº 1000/1000 R. 1000/1000	Nº 1000/1000 R. 1000/1000	Nº 1000/1000 R. 1000/1000

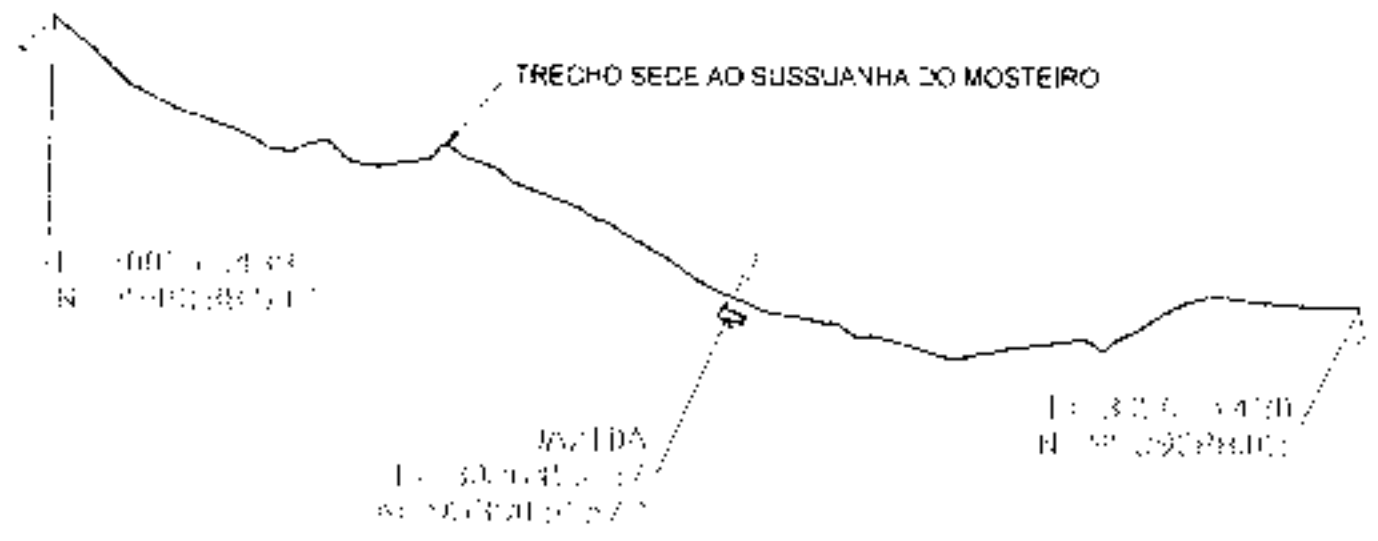

LEGENDA

- TERRENO
- L. 300.000
- N. 200.000
- L. 300.000
- N. 200.000



		<p>SECRETARIA MUNICIPAL DE LICITAÇÃO</p>	
<p>PROCESSO Nº 001/2015</p>		<p>EDITAL Nº 001/2015</p>	
<p>OBJETO: ...</p>		<p>DATA DE ABERTURA: ...</p>	
<p>LOCAL: ...</p>		<p>VALOR: ...</p>	
<p>EMPRESA: ...</p>		<p>ASSINATURA: ...</p>	

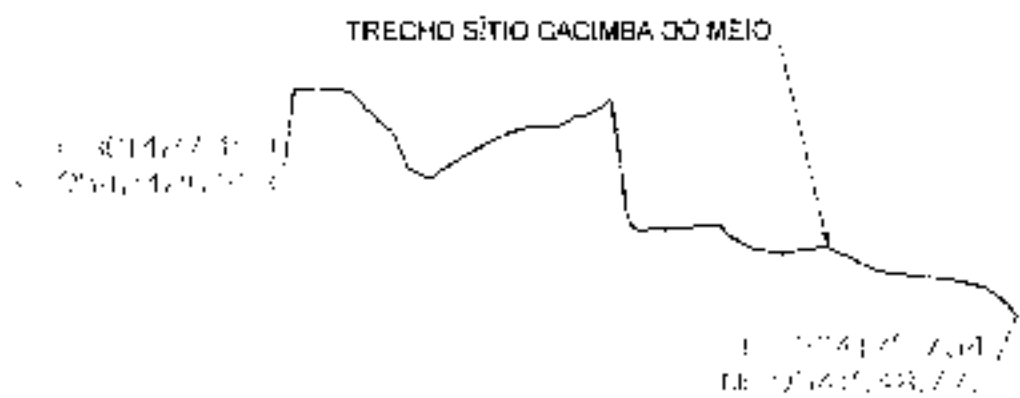

LEGENDA

- DMT
- TMT
- PLANO DE OBRAS
- RUA



CURITIBA	
SECRETARIA MUNICIPAL DE URBANISMO	
DEPARTAMENTO DE LICENCIAMENTO E FISCALIZAÇÃO	
RELAÇÃO DE OBRAS EM ANDAMENTO	
DATA DE EMISSÃO	20/01/2011
LOCAL	SÍTIO GACIMBA JO MEIO
PROPOSTA	DMT
PROJETO	1:20000
PROJETO	DE 19/01/2011
PROJETO	DE 19/01/2011
PROJETO	DE 19/01/2011
PROJETO	DE 19/01/2011

SECRETARIA MUNICIPAL DE EDUCAÇÃO
RUA... 123456789
Cidade - Estado - CEP

SECRETARIA MUNICIPAL DE EDUCAÇÃO
RUA... 123456789
Cidade - Estado - CEP

SECRETARIA MUNICIPAL DE EDUCAÇÃO
RUA... 123456789
Cidade - Estado - CEP

SECRETARIA MUNICIPAL DE EDUCAÇÃO

SECRETARIA MUNICIPAL DE EDUCAÇÃO
RUA... 123456789
Cidade - Estado - CEP



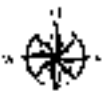

SECRETARIA MUNICIPAL DE EDUCAÇÃO	
RUA... 123456789	
Cidade - Estado - CEP	
COMISSÃO DE SELEÇÃO PÚBLICA	
RUA... 123456789	
Cidade - Estado - CEP	
NOME DO CANDIDATO	
Nº DE INSCRIÇÃO	
DATA DE INSCRIÇÃO	
LOCAL DE INSCRIÇÃO	
ASSINATURA DO CANDIDATO	
ASSINATURA DO RESPONSÁVEL	
LOCAL E DATA	



FRENCO BICA CRUZ DAS ALMAS
 Nº 15.141.000/000
 EXTENSÃO 0,55 km²
 CMT
 Nº 15.141.000/000
 Nº 15.141.000/000
 Nº 15.141.000/000

FRENCO

- _____ FRECHO
- _____ CMT
- _____ DENAS FRELHOS
- _____ JAZEA

MUNICÍPIO DE BICA CRUZ DAS ALMAS																
																
	SUPLENTE QUANTO AO DEPARTAMENTO DE ADMINISTRAÇÃO DE BICA CRUZ DAS ALMAS															
	ADMINISTRAÇÃO DE BICA CRUZ DAS ALMAS															
FRENCO DE BICA CRUZ DAS ALMAS																
<table border="1"> <tr> <td>Nº</td> <td>0,55 km²</td> <td></td> </tr> <tr> <td>EXTENSÃO</td> <td>0,55 km²</td> <td></td> </tr> <tr> <td>TERREIRO</td> <td></td> <td></td> </tr> <tr> <td>ÁREA</td> <td></td> <td></td> </tr> <tr> <td>VALOR</td> <td></td> <td></td> </tr> </table>		Nº	0,55 km ²		EXTENSÃO	0,55 km ²		TERREIRO			ÁREA			VALOR		
Nº	0,55 km ²															
EXTENSÃO	0,55 km ²															
TERREIRO																
ÁREA																
VALOR																

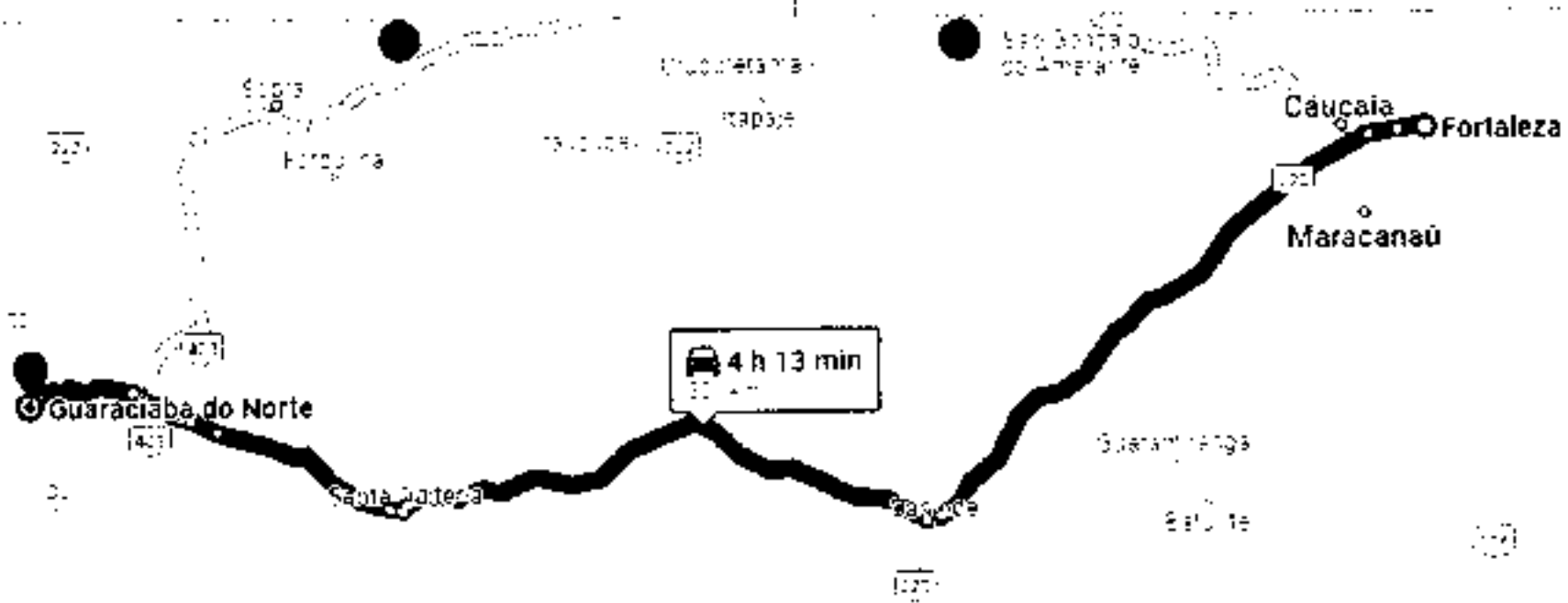

DMT
301 km

LOCAL DA OBRA
GUARACIABA DO NORTE - CE
X = 305756.00
Y = 9539634.00

USINA DE ASFALTO
FORTALEZA-CE
X = 552498.00
Y = 9536925.00

APROVAÇÃO	
	PREFEITURA MUNICIPAL DE GUARACIABA DO NORTE
	PAVIMENTAÇÃO NA ZONA URBANA DO MUNICÍPIO DE GUARACIABA-CE
	CROQUI DE LOCALIZAÇÃO DA USINA DE ASFALTO TRECHO 27 - BICA CRUZ DAS ALMAS
LOCAL: GUARACIABA DO NORTE - CE	
PROJETO DE:	
EXECUÇÃO DE:	
DATA:	

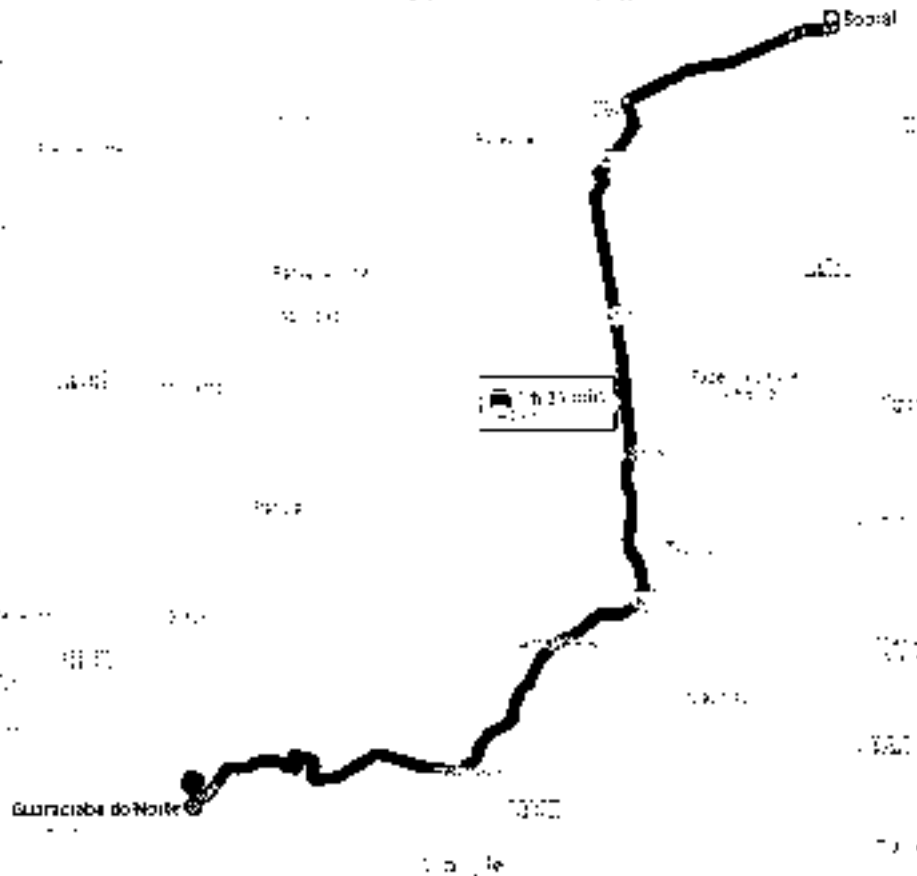

DMT
84,2 Km

LOCAL DA OBRA
GUARACIABA DO NORTE - CE
X = 305756.00
Y = 9539034.00

SOBRAL-CE
X = 349372.00
Y = 9582458.00

APROVAÇÃO			
<p>SECRETARIA</p> <p>ENGENHEIRO</p> <p>_____ <small>COM. DE LICITAÇÃO MUNICIPAL - GUARACIABA DO NORTE</small></p>			
	PREFEITURA MUNICIPAL DE GUARACIABA DO NORTE		<p>PROJETO</p> <p>CIVIL</p> <p>01-01</p>
	PAVIMENTAÇÃO NA ZONA URBANA DO MUNICÍPIO DE GUARACIABA DO NORTE		
	<p>PLANTA DE DMT - BR 74</p> <p>TRECHO 27 - BICA CRUZ DAS ALMAS</p>		
LOCAL	PÁVULO - GUARACIABA DO NORTE - CE		
PROJETO	PROJETO DE PAVIMENTAÇÃO DE BICA CRUZ DAS ALMAS - CE		
EXECUTOR	EMPRESA JOTA CARLOS PROJETO - GUARACIABA DO NORTE - CE		
EMPRESA	JOTA CARLOS		
ABRILHO	2023 - DMT PARA OBRAS DE PAVIMENTAÇÃO		



3.3
 1.000 1:1.000
 N 172.00 1:1.000



LEGENDA

- TRECHO
- DMT
- DEMAIS TRECHOS

DMT
 EXTENSÃO 6,56 km

TRECHO BICA CRUZ DAS ALMAS

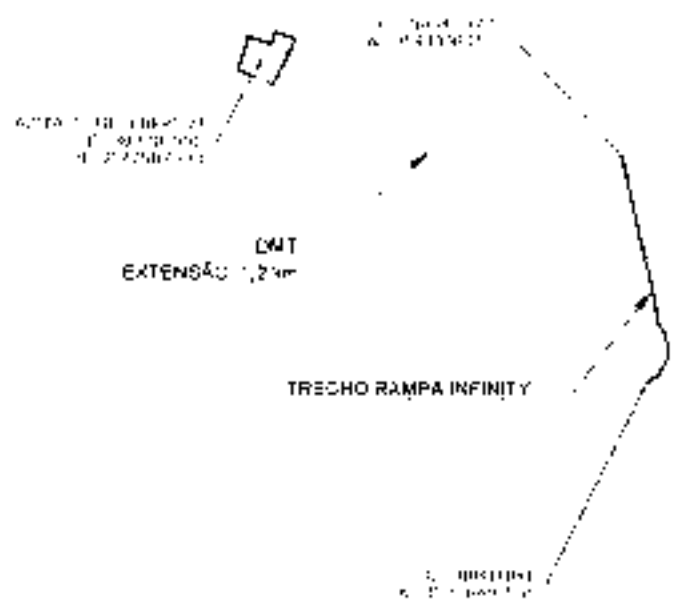

1.000 1:1.000
 N 172.00 1:1.000

APROVAÇÃO			
PROPRIETÁRIO		FUNDEADOR	
			
PREFEITURA MUNICIPAL DE CLARACIABA DO NORTE		010	0101
RECLPERAÇÃO DE ESTRADAS VICINAIS NO MUNICÍPIO DE CLARACIABA DO NORTE-CE - PI 13862/0-03			
PLANTA DE DMT - CIMENTO TRECHO 17 - BICA CRUZ DAS ALMAS			
UF	CE	 GOV. DO CEARÁ	
MUNICÍPIO	CLARACIABA DO NORTE		
PROPOSTA	PROPOSTA DE LICITAÇÃO Nº 001/2014		
EMPRESA	JOTA BARROS PROJETOS		
PROJETO	PROJETO DE LICITAÇÃO Nº 001/2014		



LEGENDA:

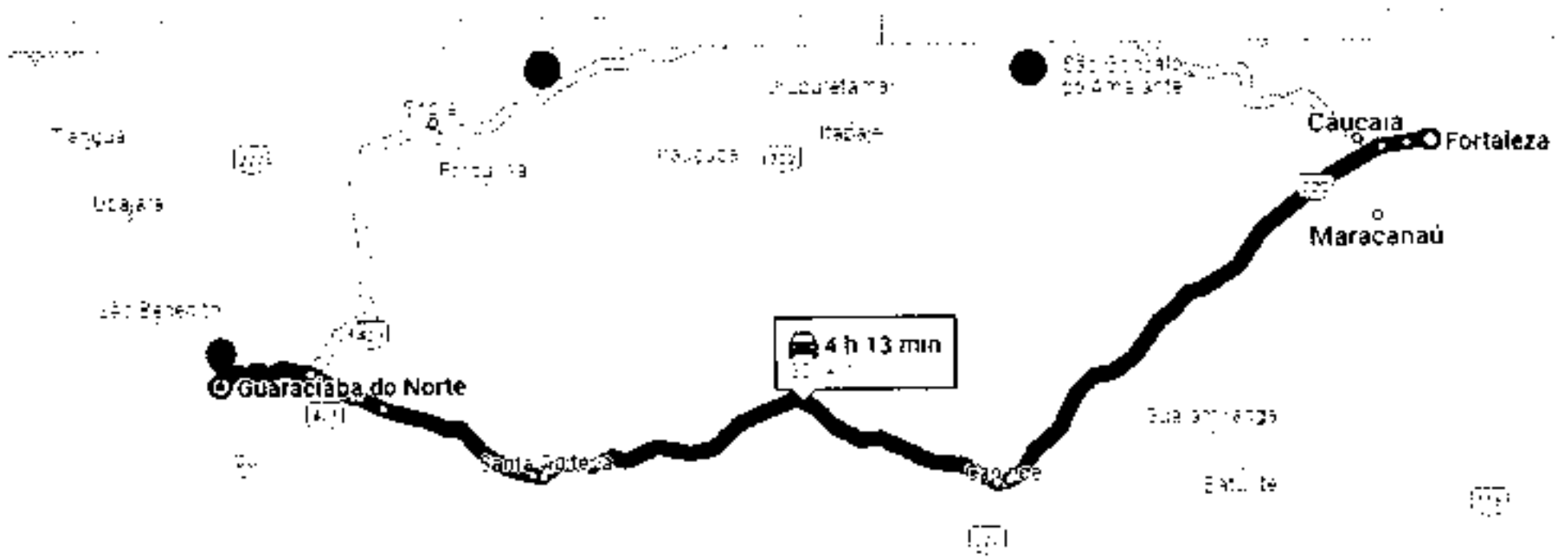

- TRECHO
- DMT
- DEMAIS TRECHOS
- JAZIDA

APPROVAÇÃO			
			
PREFEITURA MUNICIPAL DE GUARACIABÁ DO NORTE		DATA: 01/01	Nº: 01/01
RECUPERAÇÃO DE ESTRADAS VICINAS NO MUNICÍPIO DE GUARACIABÁ DO NORTE-CE - PT 1086273-03			
PLANTA DE DMT - PIÇARRA TRECHO 28 - RAMPA INFINITY			
LOCAL:	RUA CORDEIRO, GUARACIABÁ DO NORTE - CE		 Governo Municipal
PROPOSTA:	RECUPERAÇÃO DE ESTRADAS VICINAS NO MUNICÍPIO DE GUARACIABÁ DO NORTE - CE		
INICIATIVA:	PREFEITURA MUNICIPAL DE GUARACIABÁ DO NORTE - CE		
DETERMINAÇÃO:	L. 14.500/03		
ASSUNTO:	DE INVENÇÃO, MANEIO DE VEÍCULO		



LOCAL DA OBRA
 GUARACIABA DO NORTE - CE
 X = 365756.00
 Y = 9539534.00

USINA DE ASFALTO
 FORTALEZA-CE
 X = 552498.00
 Y = 9586828.00

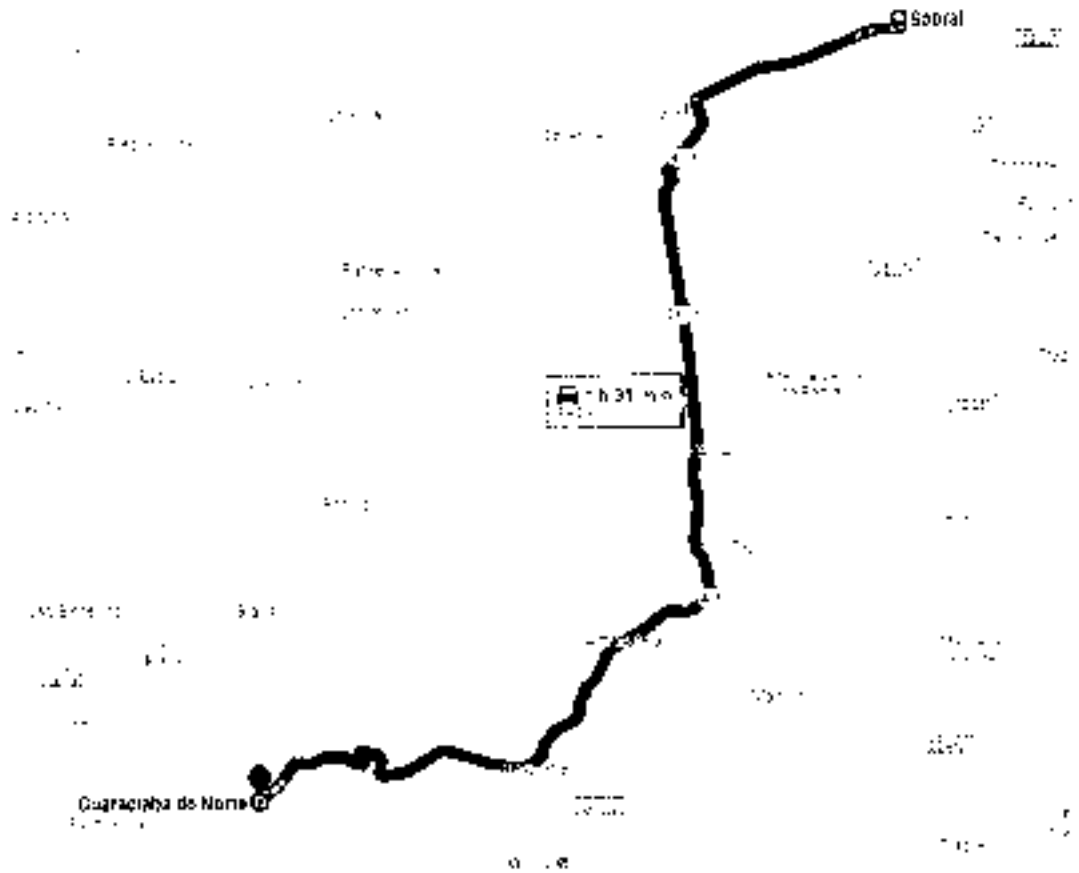

APROVAÇÃO				
		PREFEITURA MUNICIPAL DE GUARACIABA DO NORTE 01/01	01/01	
FAVIMENTAÇÃO NA ZONA URBANA DO MUNICÍPIO DE REMUTABA-CE				
ORDEN DE LOCALIZAÇÃO DA USINA DE ASFALTO TRECHO 26 - RAMPA INFINITY				
LOCAL	COMUNIDADE: GUARACIABA DO NORTE-CE			
PROPOSTA	PROPOSTA DE FAVIMENTAÇÃO DA ZONA URBANA DO MUNICÍPIO DE GUARACIABA DO NORTE-CE	PROJETO		
PROPOSTANTE	PROFESSORA MARINHO DE JOTA MARINHO PROJETO			ENTREGADA
VALOR ESTIMADO	R\$ 1.100.000,00			DATA
ABRILHO	N.º DE FOLHA 01/01 DE 01/01			ANEXO



LOCAL DA OBRA
 GUARACIABA DO NORTE - CE
 X = 305758.00
 Y = 9538834.00

SOBRAL-CE
 X = 348372.00
 Y = 9592458.00

DMT
 94.2 km

APROVAÇÃO			
PROPOSTADO		CONCEBIDA	
			
	PREFEITURA MUNICIPAL DE GUARACIABA DO NORTE		01/01
	PARÂMETROS NA ZONA URBANA DO MUNICÍPIO DE GUARACIABA DO NORTE		
	PLANTA DE DMT - BRITA TRECHO 20 - RAMPA INFINITO		
ITEM	DESCRIÇÃO - QUANTIDADE - UNIDADE		
PROPOSTA	MATERIAIS PARA OBRAS DE INFRAESTRUTURA		
REPROPOSTA	MATERIAIS PARA OBRAS DE INFRAESTRUTURA		
TERMINADA	MATERIAIS PARA OBRAS DE INFRAESTRUTURA		
REVISÃO	MATERIAIS PARA OBRAS DE INFRAESTRUTURA		



DMT
EXTENSÃO 3,09 km



LEGENDA

- TRECHO
- DMT
- DEMAIS TRECHOS

APROVAÇÃO	
PROPOSTANTE	DESTINAÇÃO
PREFEITURA MUNICIPAL DE GUARACABA DO NORTE	CIVIL
RECUPERAÇÃO DE ESTRADAS VICINAIS NO MUNICÍPIO DE GUARACABA DO NORTE-CE - PI 106627-0/03	01/01
PLANTA DE DMT - DIMENTO TRECHO 2B - RAMPAS INFINITAS	
TÍTULO	CONTRATO DE OBRAS DE RECONSTRUÇÃO DE
PROPOSTA	PI - 106627-0/03 (PI 106627-0/03)
PROPOSTANTE	PREFEITURA MUNICIPAL DE GUARACABA DO NORTE-CE
LOCALIZAÇÃO	GUARACABA
VALORES	R\$ 1.100.000,00 (UM MIL E CENTO MIL REAIS)

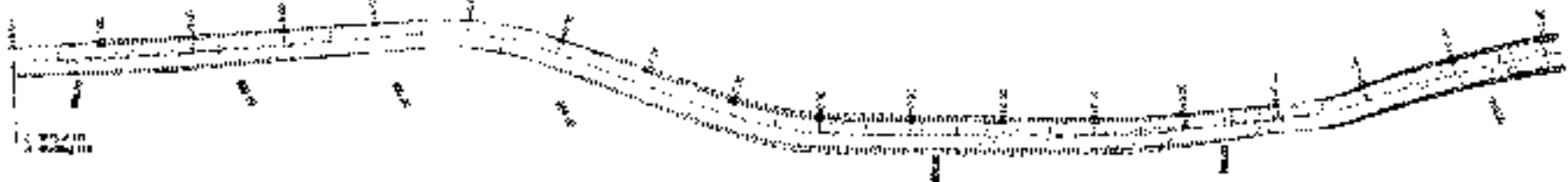

1:000 2000

Legenda - Linha da Superfície



Legenda - Linha dos Eixos



Stação	0+00	0+10	0+20	0+30	0+40	0+50	0+60	0+70	0+80	0+90	1+00	1+10	1+20	1+30	1+40	1+50	1+60	1+70	1+80	1+90	2+00	2+10	2+20	2+30	2+40	2+50	2+60	2+70	2+80	2+90	3+00	3+10	3+20		
Superfície																																			
Eixos																																			

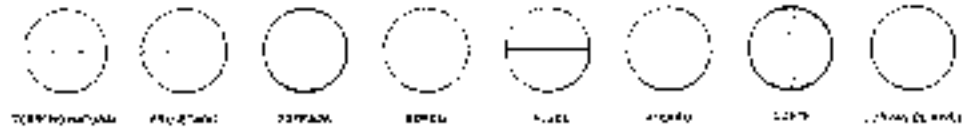

PREFEITURA MUNICIPAL DE GUARACIARA DO NORTE
 RECUPERAÇÃO DE ESTRADAS VICINAIS NO MUNICÍPIO DE GUARACIARA DO NORTE-CE - PT 1356270-03
ESTADQUEAMENTO E PERFIL LONGITUDINAL

PROJETA	JOSÉ CARLOS ALVES MORAES JUNIOR - CREA 124122/CE
ENGENH	BRUNO LACERDA S. JUNIOR - CREA 124122/CE



1 / 04
 Escala 1:100

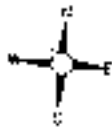

1:60 2020

Legenda - Linhas em metros

Legenda - Linhas em metros

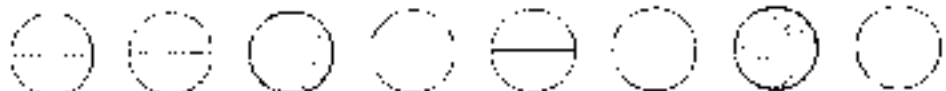
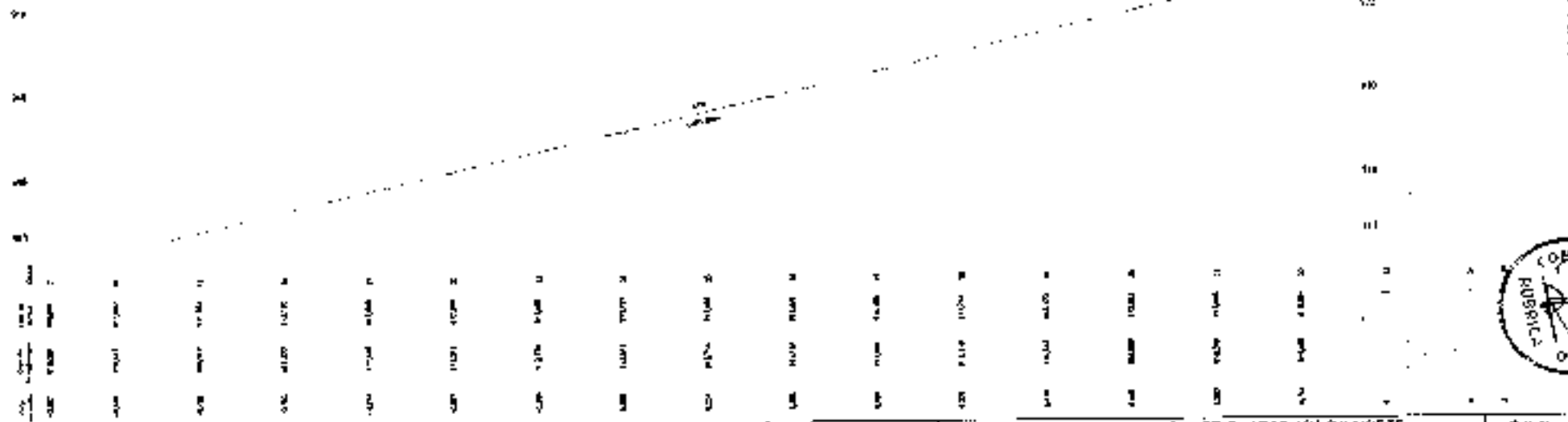

LEGENDA: LINHA DE CENTRO, LINHA DE BORDA, LINHA DE CANTO, LINHA DE PAVIMENTO, LINHA DE PAVIMENTO DE CANTO, LINHA DE PAVIMENTO DE CANTO, LINHA DE PAVIMENTO DE CANTO, LINHA DE PAVIMENTO DE CANTO

<p>JUA BARRAS S.A.</p>	<p>PREFEITURA MUNICIPAL DE GUARACIABA DO NORTE</p> <p>RECUPERAÇÃO DE ESTRADAS VICINAIS AO MUNICÍPIO DE GUARACIABA DO NORTE-CE - PT 1000270-03</p> <p>ESTADQUEAMENTO E PERFIL LONGITUDINAL</p>		<p>2 / 04</p> <p>11/03</p> <p>11/03</p>
	<p>PROJETO: [illegible]</p> <p>PROJETO: [illegible]</p>	<p>PROJETO: [illegible]</p> <p>PROJETO: [illegible]</p>	<p>PROJETO: [illegible]</p> <p>PROJETO: [illegible]</p>





1:500 ESCALA

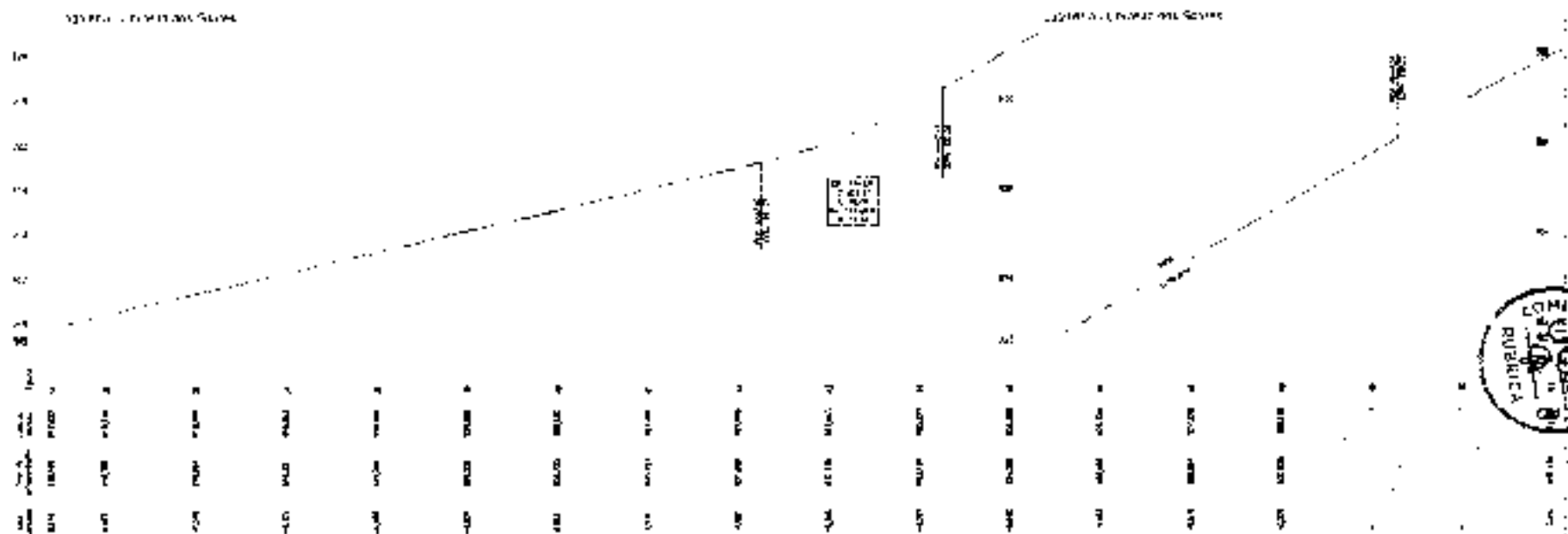

PREFEITURA MUNICIPAL DE GUARACIABA DO NORTE
 RECUPERAÇÃO DE ESTRADAS VICINAS NO MUNICÍPIO DE GUARACIABA
 CC NORTE-CE - PT 1096770-03
 ESTAQUEAMENTO E PERFIL LONGITUDINAL
 PROJETO: ENG. CIVIL - ANTONIO CARLOS FERREIRA DE LIMA
 LOCAL: MUNICÍPIO DE GUARACIABA DO NORTE - CE



3 / 04
 V. 1 / 10

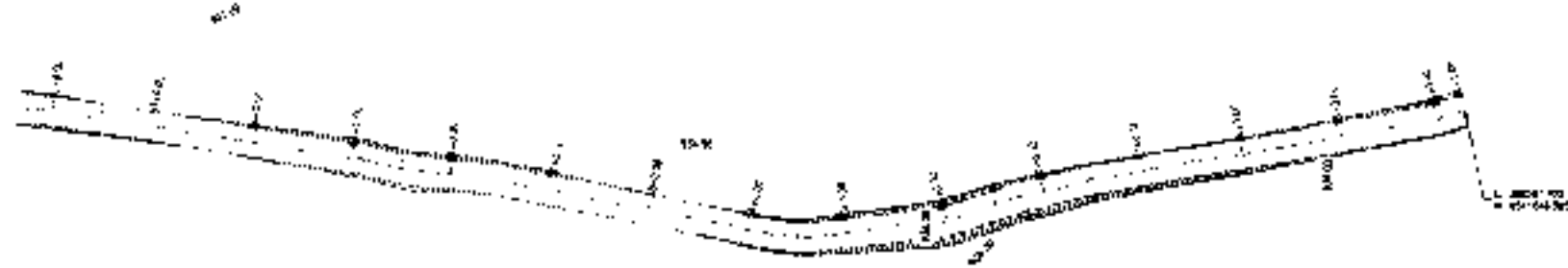

1:1000 0000

Legenda



14
12
10
8
6
4
2

1+00	1+100	1+200	1+300	1+400	1+500	1+600	1+700	1+800	1+900	1+000	1+100	1+200	1+300	1+400	1+500	1+600	1+700	1+800	1+900	1+000
1+00	1+100	1+200	1+300	1+400	1+500	1+600	1+700	1+800	1+900	1+000	1+100	1+200	1+300	1+400	1+500	1+600	1+700	1+800	1+900	1+000
1+00	1+100	1+200	1+300	1+400	1+500	1+600	1+700	1+800	1+900	1+000	1+100	1+200	1+300	1+400	1+500	1+600	1+700	1+800	1+900	1+000

1:1000

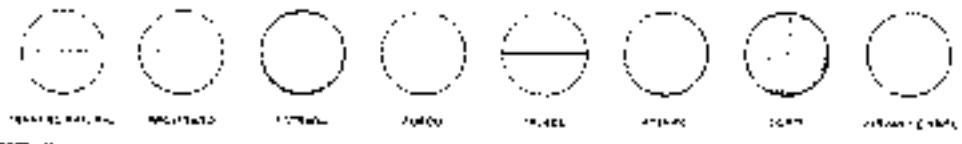

PREFEITURA MUNICIPAL DE GUARACIABA DO NORTE

RECUPERAÇÃO DE ESTRADAS VICINAIS NO MUNICÍPIO DE GUARACIABA DO NORTE - CE - RT 13862V6-03

ESTADAMENTO E PERFIL LONGITUDINAL

4 / 04

4 111 000

2 111 000

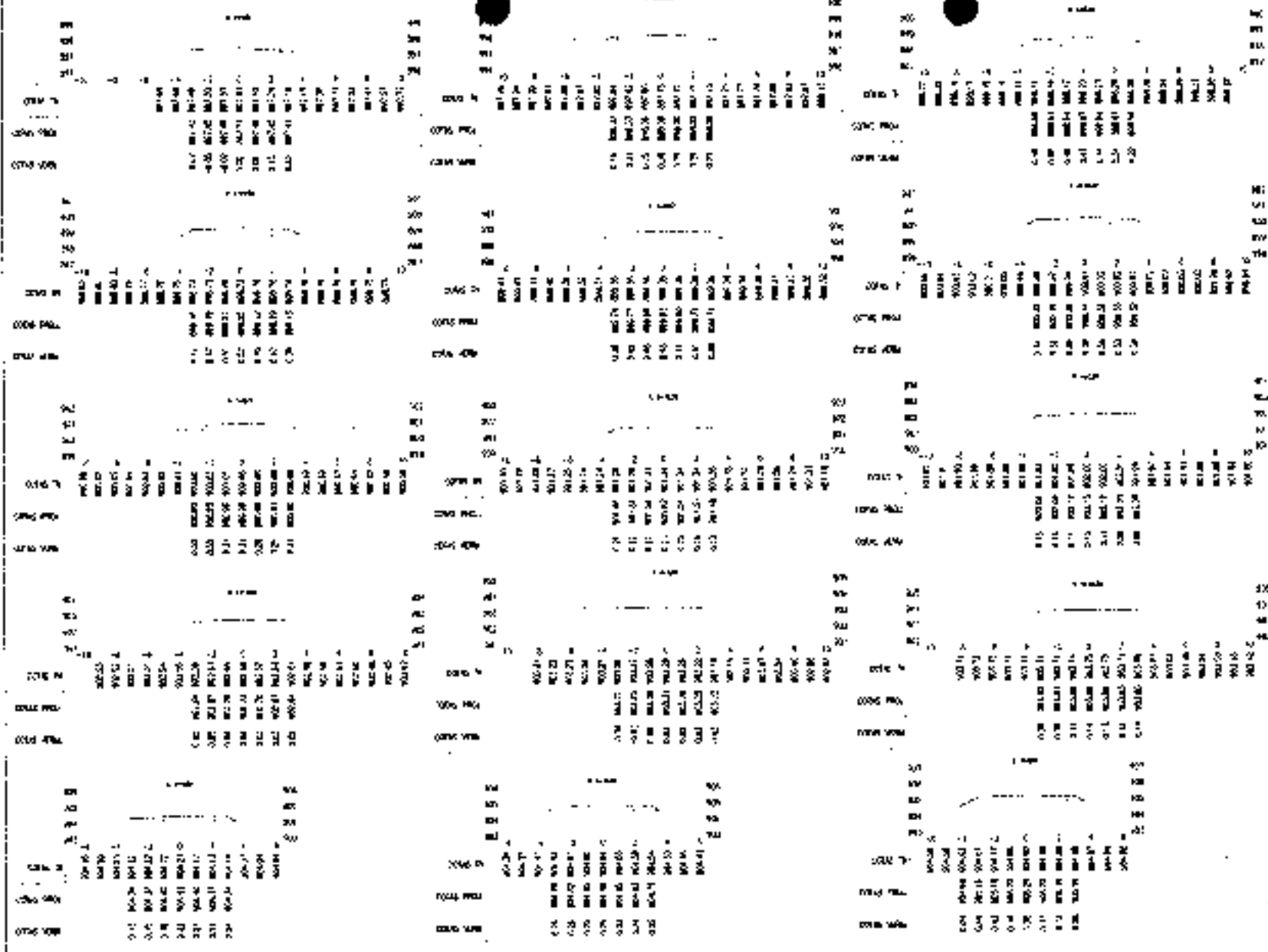

LEGENDA

ATERRO

CORTE



PROFETA TIRA MUNICIPAL DE GUARACIABA DO NORTE		escala
RECUPERAÇÃO DE ESTRADAS VIÁRIAS NO MUNICÍPIO DE GUARACIABA DO NORTE DE 01/10/2023		1:107
SEÇÕES TRANSVERSAIS		
PROJETA	PROFETA TIRA MUNICIPAL DE GUARACIABA DO NORTE	SEÇÃO
ABRIL/2023	SEÇÃO 01 - 0+00 A 0+100	0+000



Linha 1		Linha 2		Linha 3		Linha 4		Linha 5		Linha 6		Linha 7		Linha 8		Linha 9		Linha 10		Linha 11		Linha 12		Linha 13		Linha 14		Linha 15		Linha 16		Linha 17		Linha 18		Linha 19		Linha 20		Linha 21		Linha 22		Linha 23		Linha 24		Linha 25	
Nº	EM	Nº	EM	Nº	EM	Nº	EM	Nº	EM	Nº	EM	Nº	EM	Nº	EM	Nº	EM	Nº	EM	Nº	EM	Nº	EM	Nº	EM	Nº	EM	Nº	EM	Nº	EM	Nº	EM	Nº	EM	Nº	EM	Nº	EM	Nº	EM	Nº	EM	Nº	EM	Nº	EM	Nº	EM

PREFEITURA MUNICIPAL DE GUARACABA DO NORTE
 REGISTRAÇÃO DE ESTADAS VIGIÂNCIA MUNICÍPIO DE GUAPACIABA
 DO NORTE-26-PT.1088703-13



2 / 07

SEÇÕES TRANVERSAIS



LEGENDA
 ATERRO
 COARTE



3 / 07

PREFEITURA MUNICIPAL DE GUARUJÁ DO NORTE
 RECUPERAÇÃO DE ESTRADAS VICINAIS NO MUNICÍPIO DE GUARUJÁ DO NORTE - CE - Nº 10862/03-33
 SERVIÇOS DE MANUTENÇÃO E REPARAÇÃO DE OBRAS DE INFRAESTRUTURA DE TERRE E CUNJATO



SERVIÇOS TRABALHISTAS

LEGENDA
 ATERRIO
 CUNJATO

Item	Descrição	Quantidade	Valor Unitário	Valor Total
1.001
1.002
1.003
1.004
1.005
1.006
1.007
1.008
1.009
1.010
1.011
1.012
1.013
1.014
1.015
1.016
1.017
1.018
1.019
1.020
1.021
1.022
1.023
1.024
1.025
1.026
1.027
1.028
1.029
1.030
1.031
1.032
1.033
1.034
1.035
1.036
1.037
1.038
1.039
1.040
1.041
1.042
1.043
1.044
1.045
1.046
1.047
1.048
1.049
1.050
1.051
1.052
1.053
1.054
1.055
1.056
1.057
1.058
1.059
1.060
1.061
1.062
1.063
1.064
1.065
1.066
1.067
1.068
1.069
1.070
1.071
1.072
1.073
1.074
1.075
1.076
1.077
1.078
1.079
1.080
1.081
1.082
1.083
1.084
1.085
1.086
1.087
1.088
1.089
1.090
1.091
1.092
1.093
1.094
1.095
1.096
1.097
1.098
1.099
1.100

Quadra	Área (m²)	Valor	Observações
101	1000	10000	
102	1000	10000	
103	1000	10000	
104	1000	10000	
105	1000	10000	
106	1000	10000	
107	1000	10000	
108	1000	10000	
109	1000	10000	
110	1000	10000	
111	1000	10000	
112	1000	10000	
113	1000	10000	
114	1000	10000	
115	1000	10000	
116	1000	10000	
117	1000	10000	
118	1000	10000	
119	1000	10000	
120	1000	10000	
121	1000	10000	
122	1000	10000	
123	1000	10000	
124	1000	10000	
125	1000	10000	
126	1000	10000	
127	1000	10000	
128	1000	10000	
129	1000	10000	
130	1000	10000	
131	1000	10000	
132	1000	10000	
133	1000	10000	
134	1000	10000	
135	1000	10000	
136	1000	10000	
137	1000	10000	
138	1000	10000	
139	1000	10000	
140	1000	10000	
141	1000	10000	
142	1000	10000	
143	1000	10000	
144	1000	10000	
145	1000	10000	
146	1000	10000	
147	1000	10000	
148	1000	10000	
149	1000	10000	
150	1000	10000	

LEGENDA

- ATERRO
- CCP-1

PREFEITURA MUNICIPAL DE GUARUJUBÁ DO NORTE

REDE DE DRENAGEM DE ESTRADAS VARIANTE NO MUNICÍPIO DE GUARUJUBÁ DO NORTE - PC SOBRELOCA

SEÇÕES TRANSVERSAIS

4 / 07



REDAÇÃO: Rua da Alameda, 100 - Centro - Guarujubá do Norte - RN
FONE: (51) 3333-1111
E-MAIL: atendimento@jotabrunos.com.br

10/06



PREFEITURA MUNICIPAL DE GUARACIABA DO NORTE RECUPERAÇÃO DE ESTRADAS VICINAIS NO MUNICÍPIO DE GUARACIABA DO NORTE-CE - PT 1086270-03		ANEXO 5 / 07
SEÇÕES TRANSVERSAIS		ESCALA 1:1000
PROPOSTA Nº 001/2014	PROJETO EXECUTIVO DE OBRAS DE RECONSTRUÇÃO DE ESTRADAS VICINAIS	
Nº 001/2014	PROJETO EXECUTIVO DE OBRAS DE RECONSTRUÇÃO DE ESTRADAS VICINAIS	

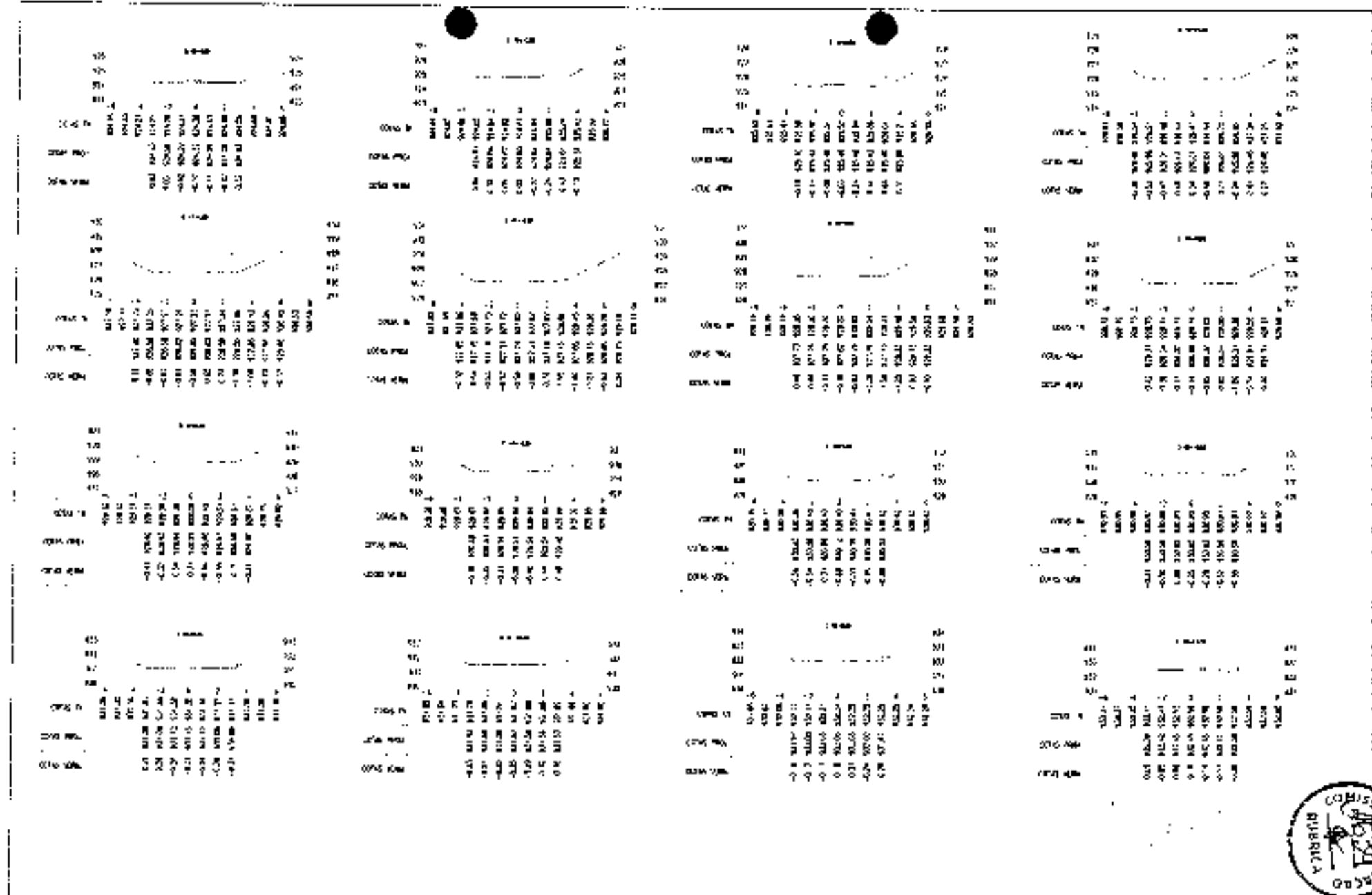

LEGENDA

ATERRO

CORTE



Lote 01		Lote 02		Lote 03		Lote 04		Lote 05		Lote 06		Lote 07		Lote 08	
Item	Descrição	Item	Descrição	Item	Descrição	Item	Descrição	Item	Descrição	Item	Descrição	Item	Descrição	Item	Descrição
01	...	01	...	01	...	01	...	01	...	01	...	01	...	01	...
02	...	02	...	02	...	02	...	02	...	02	...	02	...	02	...

PREFEITURA MUNICIPAL DE GUARAJARÁ DO NORTE

REGULAMENTO DE LICITAÇÃO Nº 001/2018

DO MUNICÍPIO DE GUARAJARÁ DO NORTE

SEÇÃO TERREIRAS

LEVE-VAZ

ATERRO

CORTE

REGISTRO Nº

001/2018

DATA

15/01/2018

6 / 07



LEGENDA

- ATERRO
- CORTA

 JOTA BARROS ENGENHARIA	PREFEITURA MUNICIPAL DE GUARACIABA DO NORTE RECUPERAÇÃO DE ESTRADAS VICINAIS NO MUNICÍPIO DE GUARACIABA DO NORTE-DE - PI 10852/0-03	Nº 107
	SEÇÕES TRANSVERSAIS	1/000

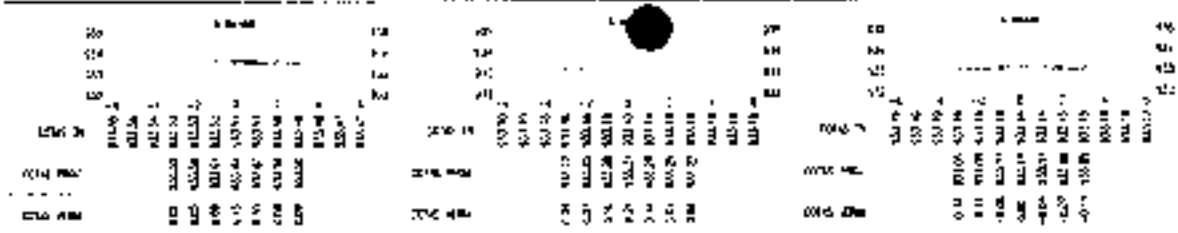

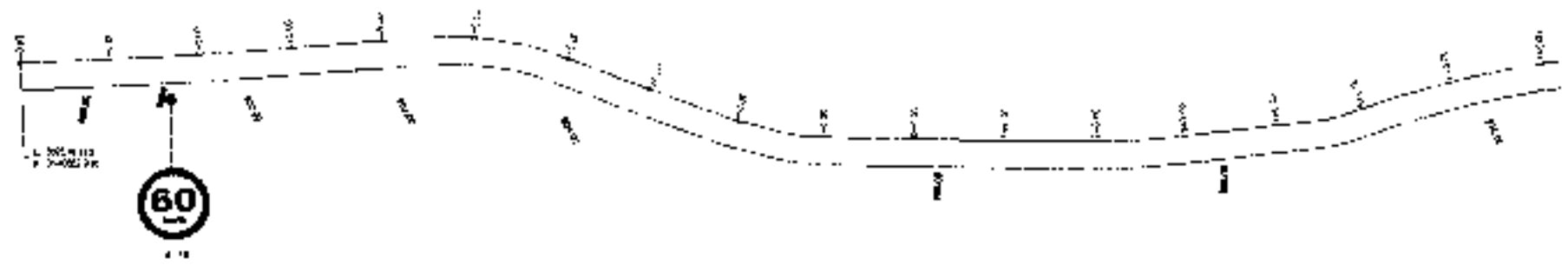

1:1000 2000

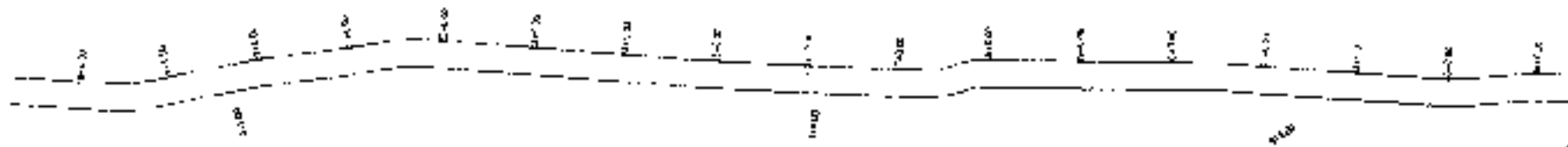

1:1000 2500



	PREFEITURA MUNICIPAL DE GUARACIABA DO NORTE RECUPERAÇÃO DE ESTRADAS VICINIAS NO MUNICÍPIO DE GUARACIABA DO NORTE-DE - PT 108270-03 SINALIZAÇÃO VIÁRIA		1 / 03
	PROPOSTA Nº 001/2003	LÍQUIDAÇÃO DE OBRAS DE INTERESSE PÚBLICO Nº 001/2003	1.000

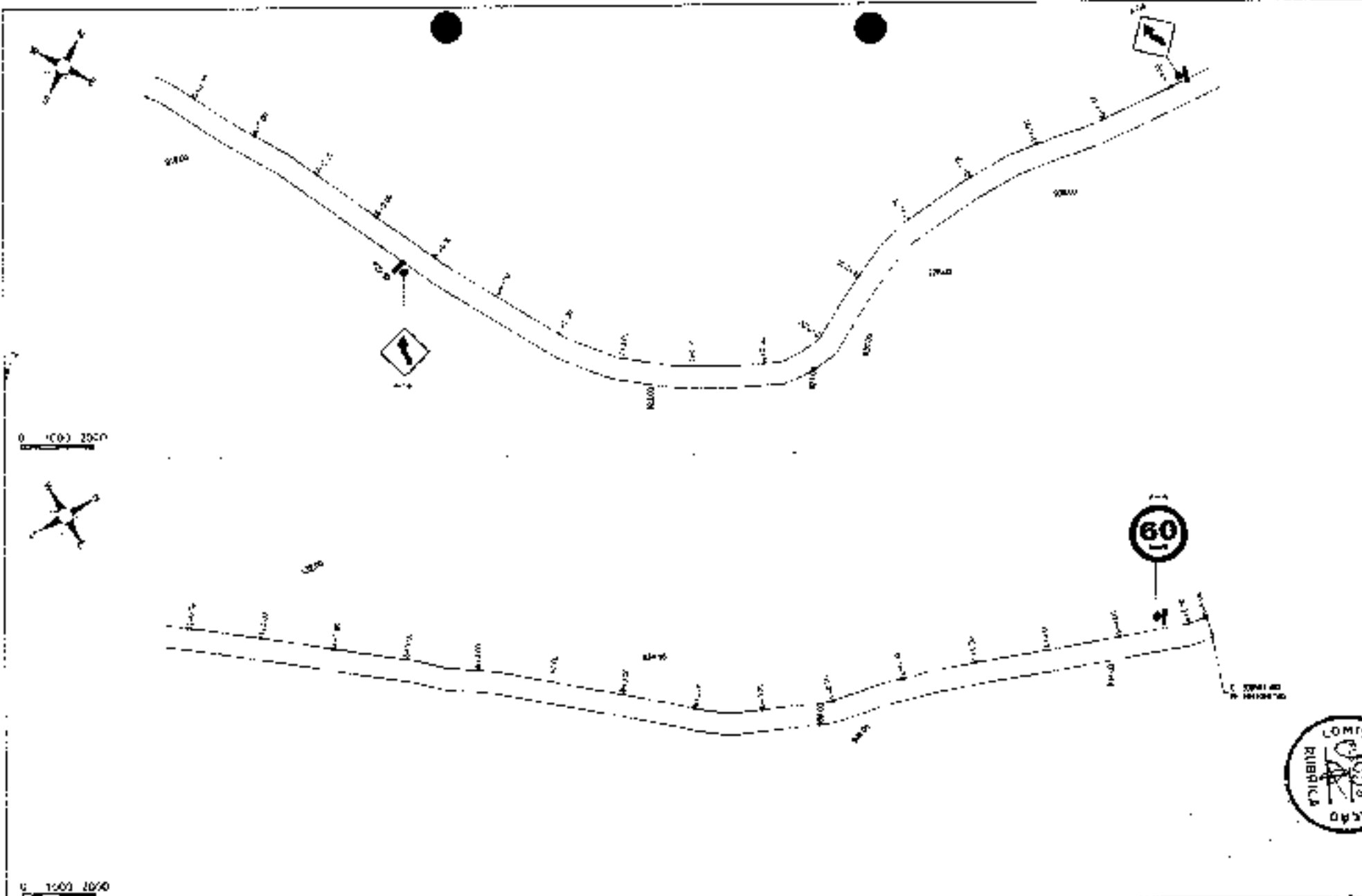

<p>SOLA BARROS PROJETOS</p>	<p>PRÉFECTURA MUNICIPAL DE GUARACIARA DO NORTE</p> <p>RECUPERAÇÃO DE ESTRADAS VICINAS NO MUNICÍPIO DE GUARACIARA DO NORTE-CE - FT 1085370/03</p> <p>SINALIZAÇÃO VIÁRIA</p>		<p>2 / 03</p>
	<p>PROJETO</p> <p>EXECUÇÃO</p>	<p>DESENVOLVIDO POR SOLA BARROS PROJETOS</p> <p>EXECUTADO POR SOLA BARROS PROJETOS</p>	<p>1/1000</p>

Posicionamento Transverso

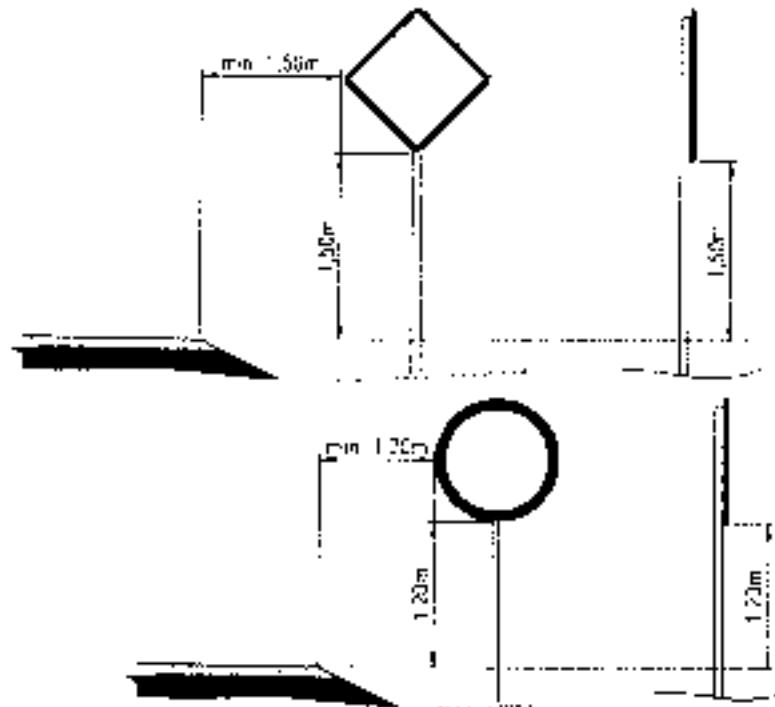

PLACAS DE ADVERTÊNCIA

PLACAS	CODIGO	COMUNICACAO	QUANTIDADE
	001	001	01

As Placas de Advertência tem as seguintes características:
 - Tamanho: 60x60cm
 - Material: Alumínio
 - Cor: Verde
 - Letra: Branca
 - Fundo: Preto

PLACAS DE ADVERTÊNCIA

PLACAS	CODIGO	COMUNICACAO	QUANTIDADE
	002	002	01

As Placas de Advertência tem as seguintes características:

- Tubo - 100x100
- Cor - Verde
- Letra - Branca
- Fundo - Preto
- Material - Alumínio
- Tamanho - 60x60
- Letra - Branca
- Fundo - Preto



PREFEITURA MUNICIPAL DE GUARACIABA DO NORTE
 RECUPERAÇÃO DE ESTRADAS VICINAIS NO MUNICÍPIO DE GUARACIABA DO NORTE-CE - PI 1096771-03
 SINALIZAÇÃO VIÁRIA

1746.00
 3 / 03
 SEM FOL.



1:2000 10.00

1:2000 10.00

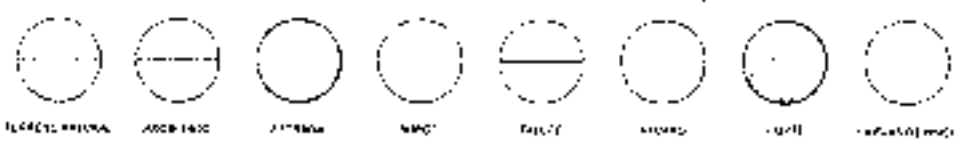
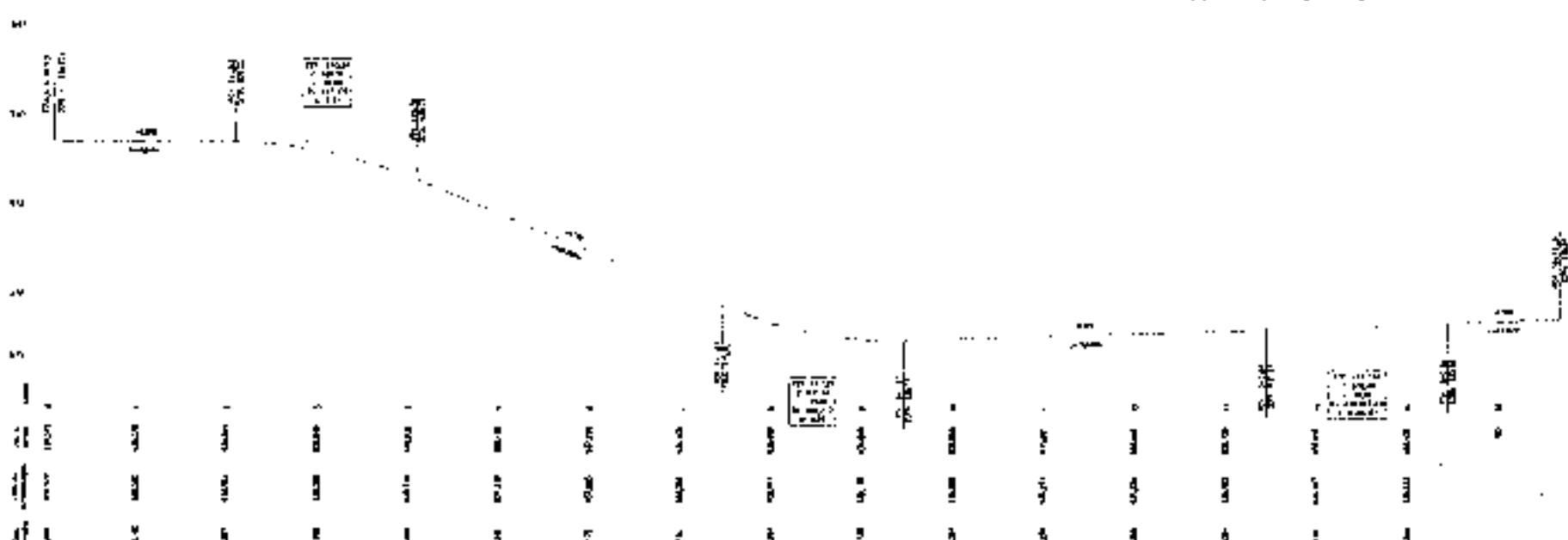

PREFEITURA MUNICIPAL DE GUARACIABA DO NORTE	
RECONSTRUÇÃO DE ESTRADAS VICINAIS NO MUNICÍPIO DE GUARACIABA DO NORTE DE 1ª ZONA URBANA	
ESTAQUEAMENTO E PERFIL LONGITUDINAL	
PROPOSTA	PROPOSTA DE PROJETO DE RECONSTRUÇÃO DE ESTRADAS VICINAIS
PROJETO	PROJETO DE RECONSTRUÇÃO DE ESTRADAS VICINAIS



1 / 04
 Escala: 1:1000
 Data: 11/11/02

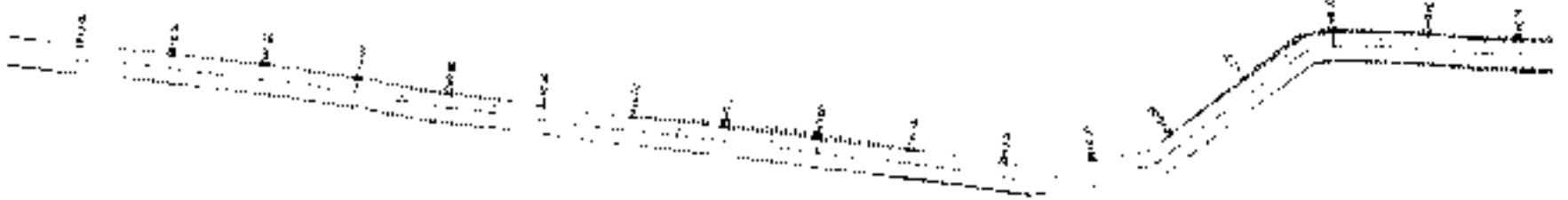
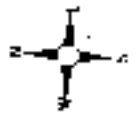

0 1000 2000

1	2	3	4	5	6	7	8	9	10
1	2	3	4	5	6	7	8	9	10

1:1000

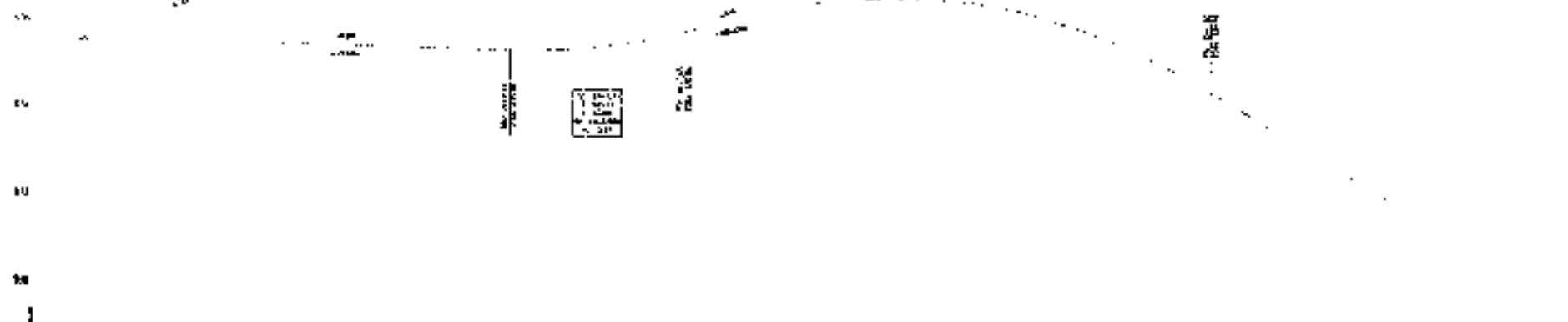

1+000	1+050	1+100	1+150	1+200	1+250	1+300	1+350	1+400	1+450	1+500	1+550	1+600	1+650	1+700	1+750	1+800	1+850	1+900
100	95	90	85	80	75	70	65	60	55	50	45	40	35	30	25	20	15	10

PROFIL EXISTENTE	PROFIL PROPOSTO	ESTRADA	BOVEDA	TALUDE	ALIVELA	COMPL	CRUZAMENTO







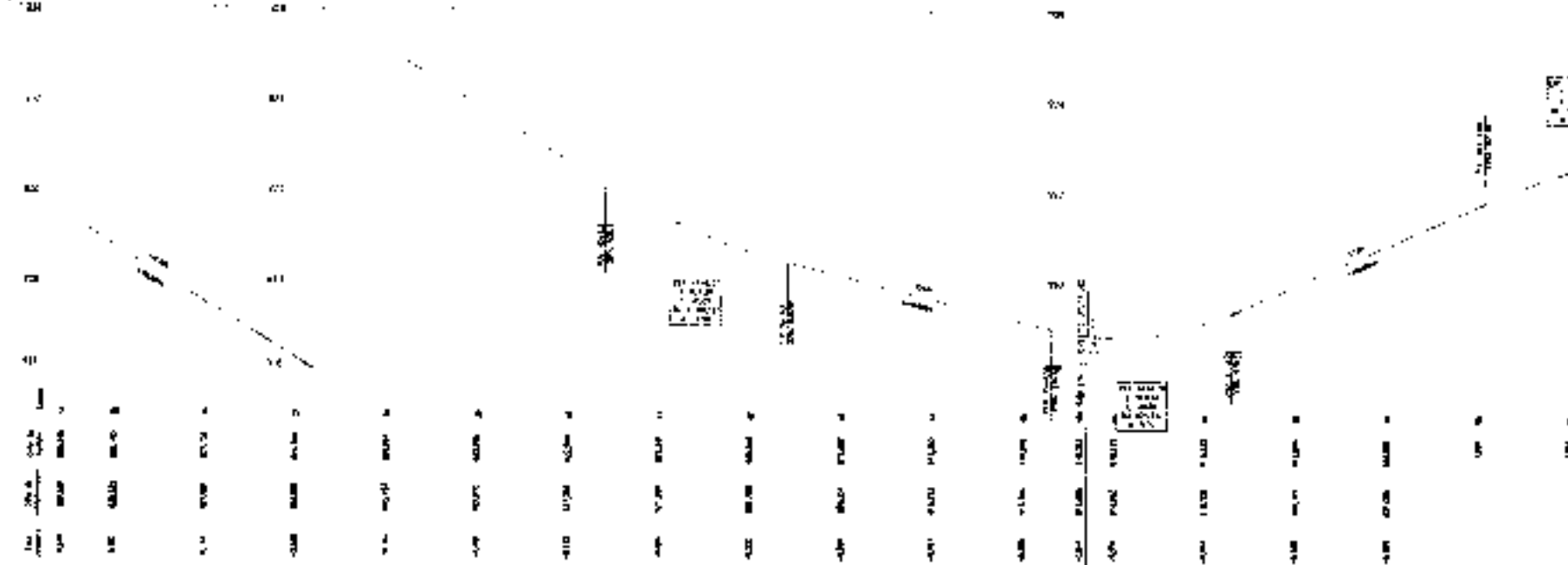
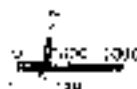
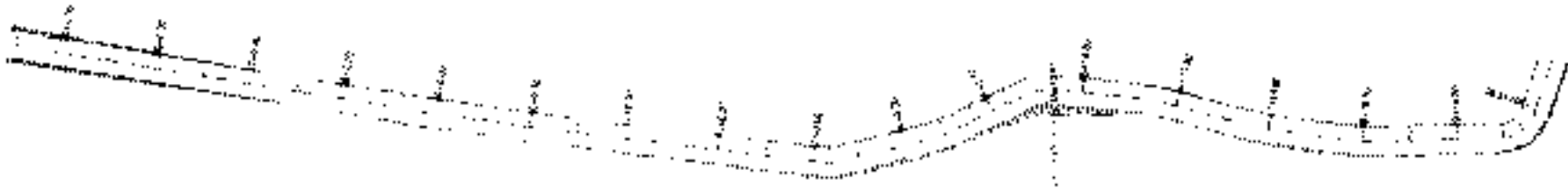

PREFEITURA MUNICIPAL DE GUARACIABA DO NORTE
 RECUPERAÇÃO DE ESTRADAS VICINAIS NO MUNICÍPIO DE GUARACIABA DO NORTE/CE - PI 1086276/03
 ESTADQUEAMENTO E PERIL LONGITUDINAL

PROJETO	PROF. DR. CARLOS ALBERTO MORAES DA SILVA - 18243 - 8004/7
PROPOSTA	PARA OBRAS DE RECONSTRUÇÃO DE 03 KM



2 / 04
 DATA: 14/10/02
 LOCAL: CE

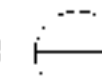

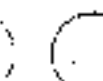
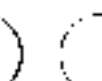
-  PERFIL LONGITUDINAL
-  CURVA VERTICAL
-  ESTACIONAMENTO
-  CORTE
-  LARGURA
-  INCLINAÇÃO
-  TIPO DE PAVIMENTO
-  NOME DA RUA



PREFEITURA MUNICIPAL DE GUARACARA DO NORTE
 RECUPERAÇÃO DE ESTRADAS VICINAIS NO MUNICÍPIO DE GUARACARA DO NORTE - CE - 10827045
ESTAQUEAMENTO E PERFIL LONGITUDINAL
 PROJETO DE: [blank]
 ARQUIVO: [blank]



3 / 04
 DATA: [blank]
 LOCAL: [blank]



1:1000 2050



metros

30

20

10

0



1	2	3	4	5	6	7	8
1	2	3	4	5	6	7	8
1	2	3	4	5	6	7	8



PREFEITURA MUNICIPAL DE GUARACIABA DO NORTE		4104
RECONSTRUÇÃO DE ESTRADAS VICINAIS NO MUNICÍPIO DE GUARACIABA DO NORTE - PE - PT 1086279-03		17/1002
ESTAQUEAMENTO E PERFIL LONGITUDINAL		11112
PROJETA	PROF. CARLOS AUGUSTO FERREIRA DE OLIVEIRA	
ENGENHO	ENGENHEIRO CARLOS AUGUSTO FERREIRA DE OLIVEIRA	



LEGENDA

- ATERRO
- COU'E



PREFEITURA MUNICIPAL DE GUARACIABA DO NORTE
 RECUPERAÇÃO DE ESTRADAS VICINAIS NO MUNICÍPIO DE GUARACIABA
 DO NORTE-CE - PT 10862/0-03
 SEÇÕES TRANSVERSAIS

1 / 08

PROJETO	RECUPERAÇÃO DE ESTRADAS VICINAIS NO MUNICÍPIO DE GUARACIABA DO NORTE-CE - PT 10862/0-03
PROJETA	JOÃO VARGAS ENGENHARIA

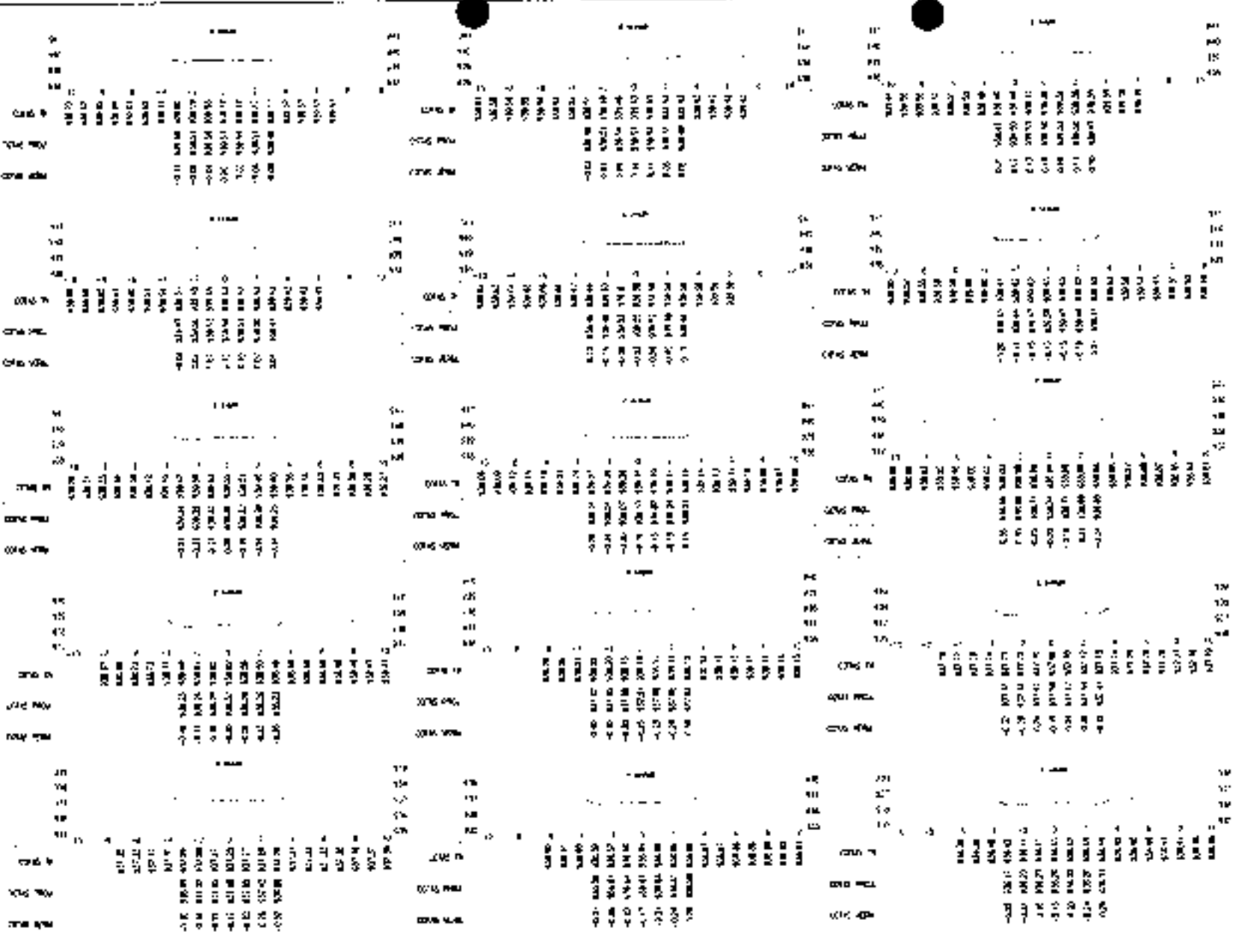

LEGENDA

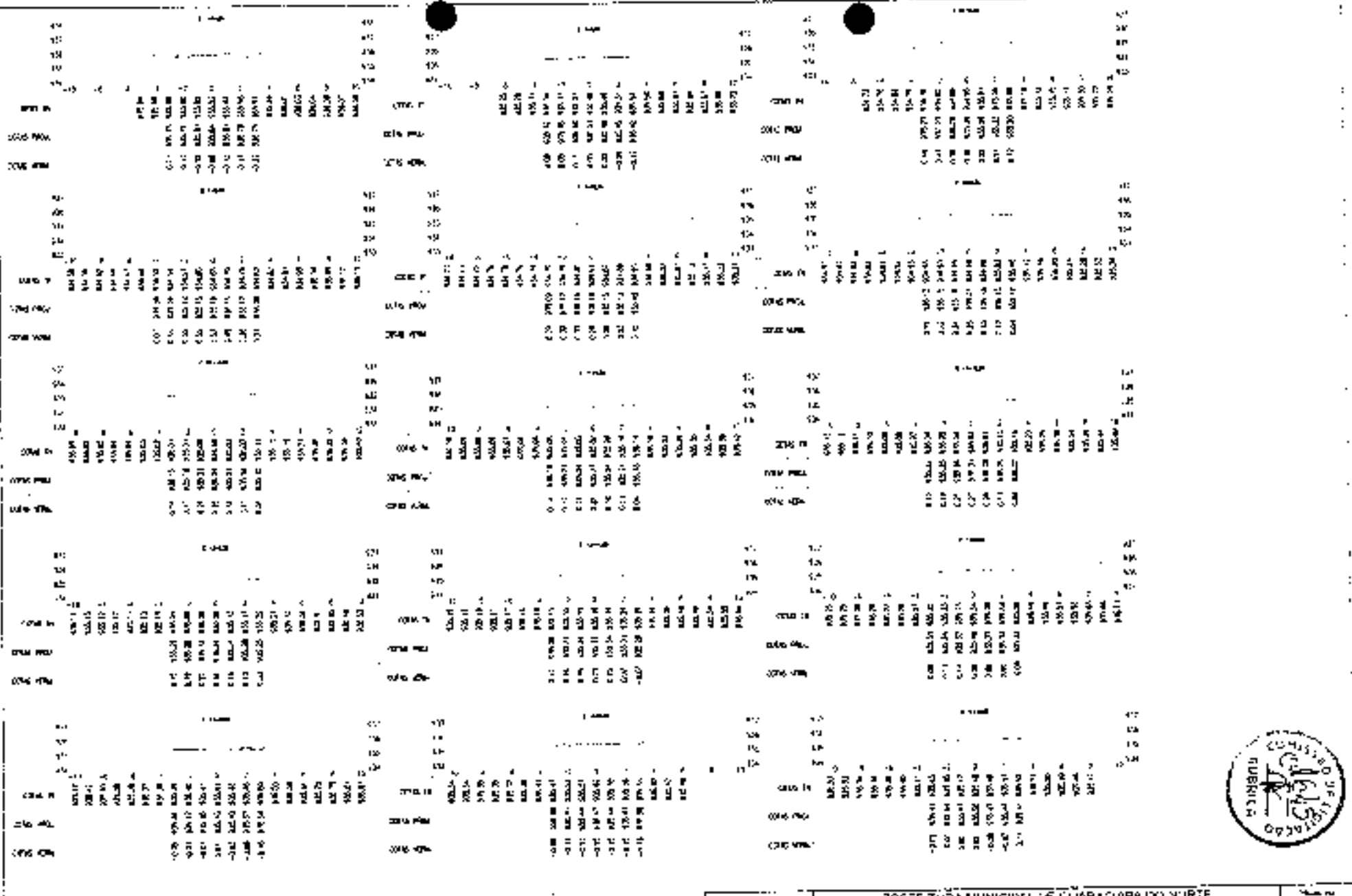
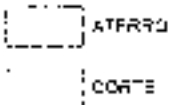

	PREFEITURA MUNICIPAL DE GUARACIABA DO NORTE RECUPERAÇÃO DE ESTRADAS VICARIAS NO MUNICÍPIO DE GUARACIABA DO NORTE - CE - P1 1086/279-01		2 / 08
	SEÇÕES TRANSVERSAIS		1056
REVISÃO: _____ DATA: _____	PROJETO: _____ DATA: _____		1056



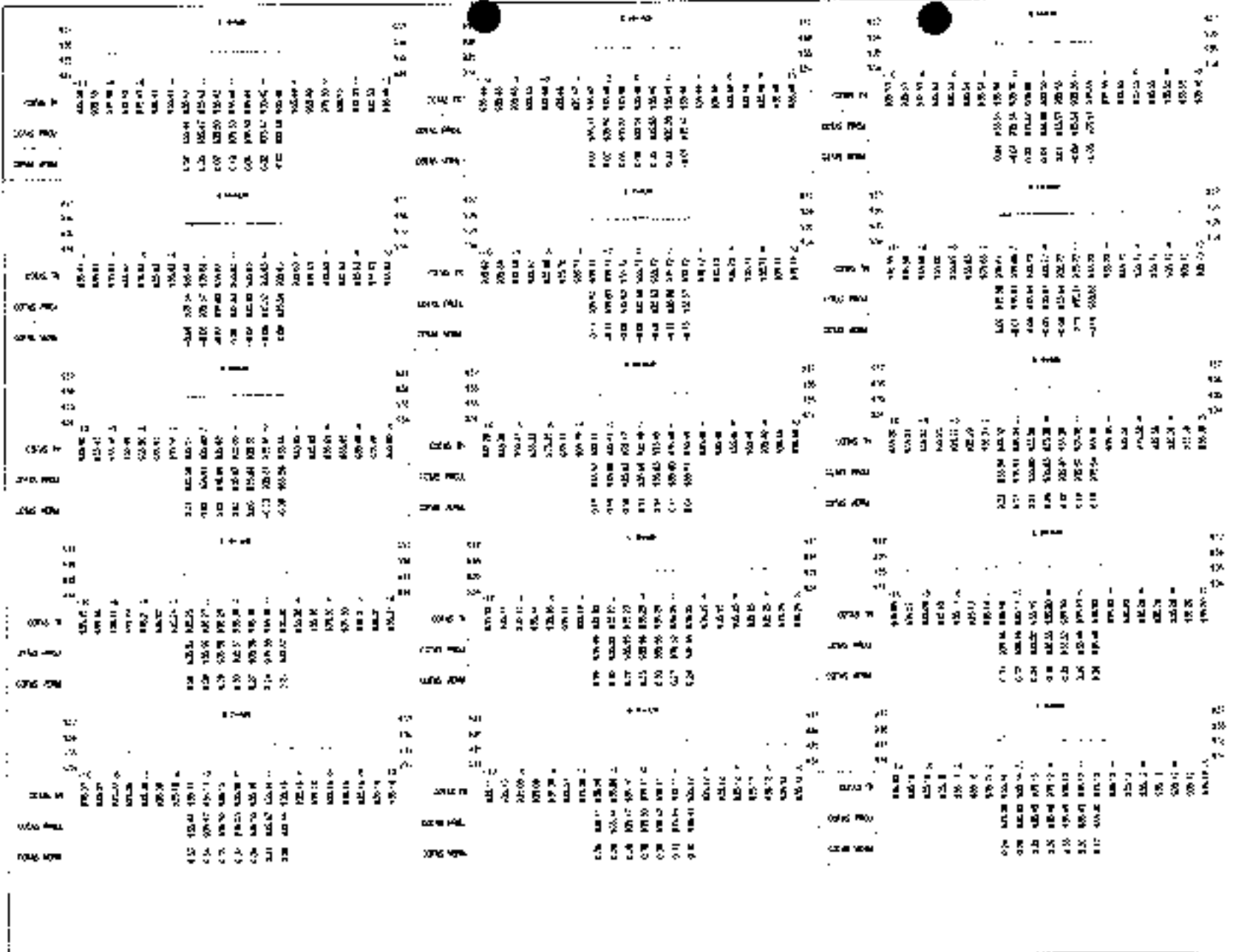

LEGENDA

----- ATERRO

----- CORTE

 <p>JOTA TAVARES ENGENHARIA</p>	PREFEITURA MUNICIPAL DE GLÓRIA DO NORTE RECUPERAÇÃO DE ESTRADAS VICINAIS NO MUNICÍPIO DE GLÓRIA DO NORTE - CE - PT 1095270-03 SEÇÕES TRANSVERSAIS		PLANOS 3 / 02 DATA 1/2010
	ANALISTA Eng.º CIVIL CARLOS EDUARDO FERREIRA DE SOUZA		
	ARQUITETA Eng.ª ARQUITETA CAROLINA DE OLIVEIRA COSTA		

LEGENDA

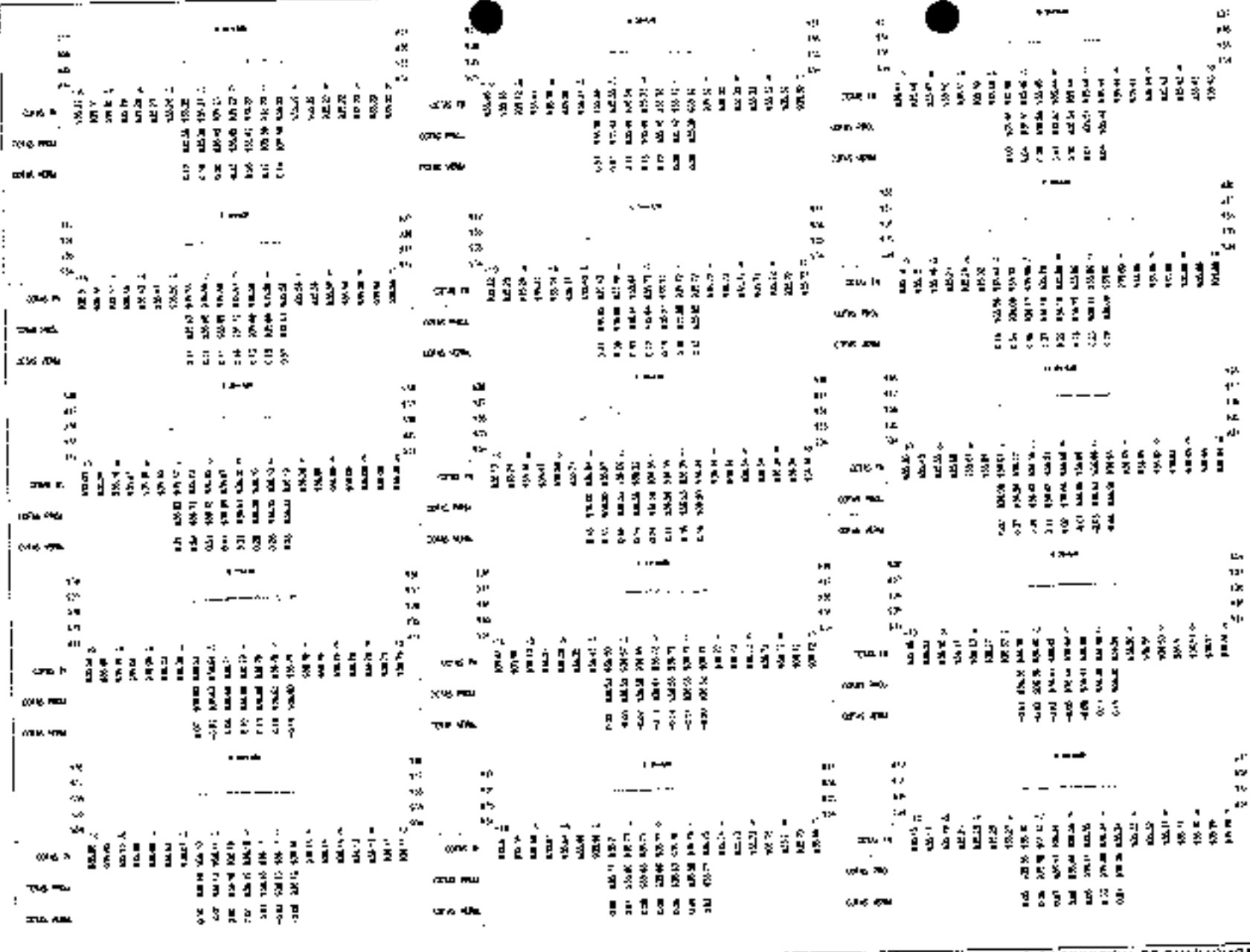
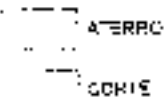

	PREFEITURA MUNICIPAL DE GUARACIABA DO NORTE RECUPERAÇÃO DE ESTRADAS VICINAIS NO MUNICÍPIO DE GUARACIABA DO NORTE - CE - PP 1082/2015 SEÇÕES TRANSVERSAIS		Nº 4 / 08
	Nº 1256	DATA: 15/08/2015 LOCAL: GUARACIABA DO NORTE - CE	



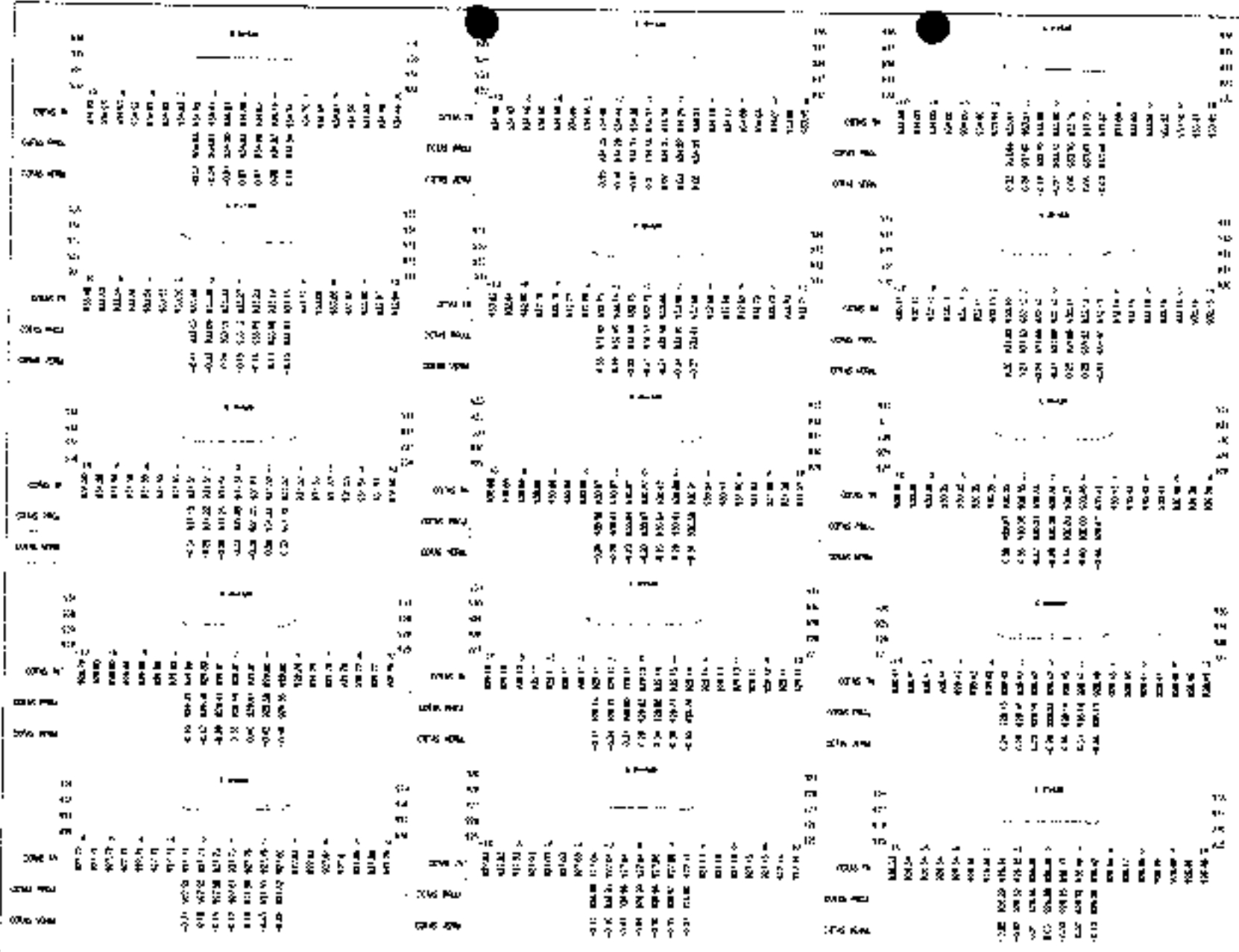

LEGENDA

- ATERRO
- CORTE



PREFEITURA MUNICIPAL DE GUARACIABA DO NORTE RECUPERAÇÃO DE ESTRADAS VICINAIS NO MUNICÍPIO DE GUARACIABA DO NORTE-CE - PI 1395273-03 SEÇÃO TRANSVERSAL		Nº de Ob. 5 / 08 Folha 11,57
PROFESSOR	PROF. DR. CARLOS ALBERTO FERREIRA	
PROJETO	PROJ. CIVIL DE RECONSTRUÇÃO DE ESTRADAS VICINAIS	



LC INENDA

ATERRO

CORTE



PREFEITURA MUNICIPAL DE GUARACIARA DO NORTE
 RECUPERAÇÃO DE ESTRADAS VICINAIS NO MUNICÍPIO DE GUARACIARA DO NORTE-CE - PT. "DASOITE-CJ"
 SEÇÕES TRANSVERSAIS

PROJETO: LIG. EN. 01 - 02 - 03 - 04 - 05 - 06 - 07 - 08 - 09 - 10 - 11 - 12 - 13 - 14 - 15 - 16 - 17 - 18 - 19 - 20 - 21 - 22 - 23 - 24 - 25 - 26 - 27 - 28 - 29 - 30 - 31 - 32 - 33 - 34 - 35 - 36 - 37 - 38 - 39 - 40 - 41 - 42 - 43 - 44 - 45 - 46 - 47 - 48 - 49 - 50 - 51 - 52 - 53 - 54 - 55 - 56 - 57 - 58 - 59 - 60 - 61 - 62 - 63 - 64 - 65 - 66 - 67 - 68 - 69 - 70 - 71 - 72 - 73 - 74 - 75 - 76 - 77 - 78 - 79 - 80 - 81 - 82 - 83 - 84 - 85 - 86 - 87 - 88 - 89 - 90 - 91 - 92 - 93 - 94 - 95 - 96 - 97 - 98 - 99 - 100 - 101 - 102 - 103 - 104 - 105 - 106 - 107 - 108 - 109 - 110 - 111 - 112 - 113 - 114 - 115 - 116 - 117 - 118 - 119 - 120 - 121 - 122 - 123 - 124 - 125 - 126 - 127 - 128 - 129 - 130 - 131 - 132 - 133 - 134 - 135 - 136 - 137 - 138 - 139 - 140 - 141 - 142 - 143 - 144 - 145 - 146 - 147 - 148 - 149 - 150 - 151 - 152 - 153 - 154 - 155 - 156 - 157 - 158 - 159 - 160 - 161 - 162 - 163 - 164 - 165 - 166 - 167 - 168 - 169 - 170 - 171 - 172 - 173 - 174 - 175 - 176 - 177 - 178 - 179 - 180 - 181 - 182 - 183 - 184 - 185 - 186 - 187 - 188 - 189 - 190 - 191 - 192 - 193 - 194 - 195 - 196 - 197 - 198 - 199 - 200 - 201 - 202 - 203 - 204 - 205 - 206 - 207 - 208 - 209 - 210 - 211 - 212 - 213 - 214 - 215 - 216 - 217 - 218 - 219 - 220 - 221 - 222 - 223 - 224 - 225 - 226 - 227 - 228 - 229 - 230 - 231 - 232 - 233 - 234 - 235 - 236 - 237 - 238 - 239 - 240 - 241 - 242 - 243 - 244 - 245 - 246 - 247 - 248 - 249 - 250 - 251 - 252 - 253 - 254 - 255 - 256 - 257 - 258 - 259 - 260 - 261 - 262 - 263 - 264 - 265 - 266 - 267 - 268 - 269 - 270 - 271 - 272 - 273 - 274 - 275 - 276 - 277 - 278 - 279 - 280 - 281 - 282 - 283 - 284 - 285 - 286 - 287 - 288 - 289 - 290 - 291 - 292 - 293 - 294 - 295 - 296 - 297 - 298 - 299 - 300 - 301 - 302 - 303 - 304 - 305 - 306 - 307 - 308 - 309 - 310 - 311 - 312 - 313 - 314 - 315 - 316 - 317 - 318 - 319 - 320 - 321 - 322 - 323 - 324 - 325 - 326 - 327 - 328 - 329 - 330 - 331 - 332 - 333 - 334 - 335 - 336 - 337 - 338 - 339 - 340 - 341 - 342 - 343 - 344 - 345 - 346 - 347 - 348 - 349 - 350 - 351 - 352 - 353 - 354 - 355 - 356 - 357 - 358 - 359 - 360 - 361 - 362 - 363 - 364 - 365 - 366 - 367 - 368 - 369 - 370 - 371 - 372 - 373 - 374 - 375 - 376 - 377 - 378 - 379 - 380 - 381 - 382 - 383 - 384 - 385 - 386 - 387 - 388 - 389 - 390 - 391 - 392 - 393 - 394 - 395 - 396 - 397 - 398 - 399 - 400 - 401 - 402 - 403 - 404 - 405 - 406 - 407 - 408 - 409 - 410 - 411 - 412 - 413 - 414 - 415 - 416 - 417 - 418 - 419 - 420 - 421 - 422 - 423 - 424 - 425 - 426 - 427 - 428 - 429 - 430 - 431 - 432 - 433 - 434 - 435 - 436 - 437 - 438 - 439 - 440 - 441 - 442 - 443 - 444 - 445 - 446 - 447 - 448 - 449 - 450 - 451 - 452 - 453 - 454 - 455 - 456 - 457 - 458 - 459 - 460 - 461 - 462 - 463 - 464 - 465 - 466 - 467 - 468 - 469 - 470 - 471 - 472 - 473 - 474 - 475 - 476 - 477 - 478 - 479 - 480 - 481 - 482 - 483 - 484 - 485 - 486 - 487 - 488 - 489 - 490 - 491 - 492 - 493 - 494 - 495 - 496 - 497 - 498 - 499 - 500 - 501 - 502 - 503 - 504 - 505 - 506 - 507 - 508 - 509 - 510 - 511 - 512 - 513 - 514 - 515 - 516 - 517 - 518 - 519 - 520 - 521 - 522 - 523 - 524 - 525 - 526 - 527 - 528 - 529 - 530 - 531 - 532 - 533 - 534 - 535 - 536 - 537 - 538 - 539 - 540 - 541 - 542 - 543 - 544 - 545 - 546 - 547 - 548 - 549 - 550 - 551 - 552 - 553 - 554 - 555 - 556 - 557 - 558 - 559 - 560 - 561 - 562 - 563 - 564 - 565 - 566 - 567 - 568 - 569 - 570 - 571 - 572 - 573 - 574 - 575 - 576 - 577 - 578 - 579 - 580 - 581 - 582 - 583 - 584 - 585 - 586 - 587 - 588 - 589 - 590 - 591 - 592 - 593 - 594 - 595 - 596 - 597 - 598 - 599 - 600 - 601 - 602 - 603 - 604 - 605 - 606 - 607 - 608 - 609 - 610 - 611 - 612 - 613 - 614 - 615 - 616 - 617 - 618 - 619 - 620 - 621 - 622 - 623 - 624 - 625 - 626 - 627 - 628 - 629 - 630 - 631 - 632 - 633 - 634 - 635 - 636 - 637 - 638 - 639 - 640 - 641 - 642 - 643 - 644 - 645 - 646 - 647 - 648 - 649 - 650 - 651 - 652 - 653 - 654 - 655 - 656 - 657 - 658 - 659 - 660 - 661 - 662 - 663 - 664 - 665 - 666 - 667 - 668 - 669 - 670 - 671 - 672 - 673 - 674 - 675 - 676 - 677 - 678 - 679 - 680 - 681 - 682 - 683 - 684 - 685 - 686 - 687 - 688 - 689 - 690 - 691 - 692 - 693 - 694 - 695 - 696 - 697 - 698 - 699 - 700 - 701 - 702 - 703 - 704 - 705 - 706 - 707 - 708 - 709 - 710 - 711 - 712 - 713 - 714 - 715 - 716 - 717 - 718 - 719 - 720 - 721 - 722 - 723 - 724 - 725 - 726 - 727 - 728 - 729 - 730 - 731 - 732 - 733 - 734 - 735 - 736 - 737 - 738 - 739 - 740 - 741 - 742 - 743 - 744 - 745 - 746 - 747 - 748 - 749 - 750 - 751 - 752 - 753 - 754 - 755 - 756 - 757 - 758 - 759 - 760 - 761 - 762 - 763 - 764 - 765 - 766 - 767 - 768 - 769 - 770 - 771 - 772 - 773 - 774 - 775 - 776 - 777 - 778 - 779 - 780 - 781 - 782 - 783 - 784 - 785 - 786 - 787 - 788 - 789 - 790 - 791 - 792 - 793 - 794 - 795 - 796 - 797 - 798 - 799 - 800 - 801 - 802 - 803 - 804 - 805 - 806 - 807 - 808 - 809 - 810 - 811 - 812 - 813 - 814 - 815 - 816 - 817 - 818 - 819 - 820 - 821 - 822 - 823 - 824 - 825 - 826 - 827 - 828 - 829 - 830 - 831 - 832 - 833 - 834 - 835 - 836 - 837 - 838 - 839 - 840 - 841 - 842 - 843 - 844 - 845 - 846 - 847 - 848 - 849 - 850 - 851 - 852 - 853 - 854 - 855 - 856 - 857 - 858 - 859 - 860 - 861 - 862 - 863 - 864 - 865 - 866 - 867 - 868 - 869 - 870 - 871 - 872 - 873 - 874 - 875 - 876 - 877 - 878 - 879 - 880 - 881 - 882 - 883 - 884 - 885 - 886 - 887 - 888 - 889 - 890 - 891 - 892 - 893 - 894 - 895 - 896 - 897 - 898 - 899 - 900 - 901 - 902 - 903 - 904 - 905 - 906 - 907 - 908 - 909 - 910 - 911 - 912 - 913 - 914 - 915 - 916 - 917 - 918 - 919 - 920 - 921 - 922 - 923 - 924 - 925 - 926 - 927 - 928 - 929 - 930 - 931 - 932 - 933 - 934 - 935 - 936 - 937 - 938 - 939 - 940 - 941 - 942 - 943 - 944 - 945 - 946 - 947 - 948 - 949 - 950 - 951 - 952 - 953 - 954 - 955 - 956 - 957 - 958 - 959 - 960 - 961 - 962 - 963 - 964 - 965 - 966 - 967 - 968 - 969 - 970 - 971 - 972 - 973 - 974 - 975 - 976 - 977 - 978 - 979 - 980 - 981 - 982 - 983 - 984 - 985 - 986 - 987 - 988 - 989 - 990 - 991 - 992 - 993 - 994 - 995 - 996 - 997 - 998 - 999 - 1000

6 / 08



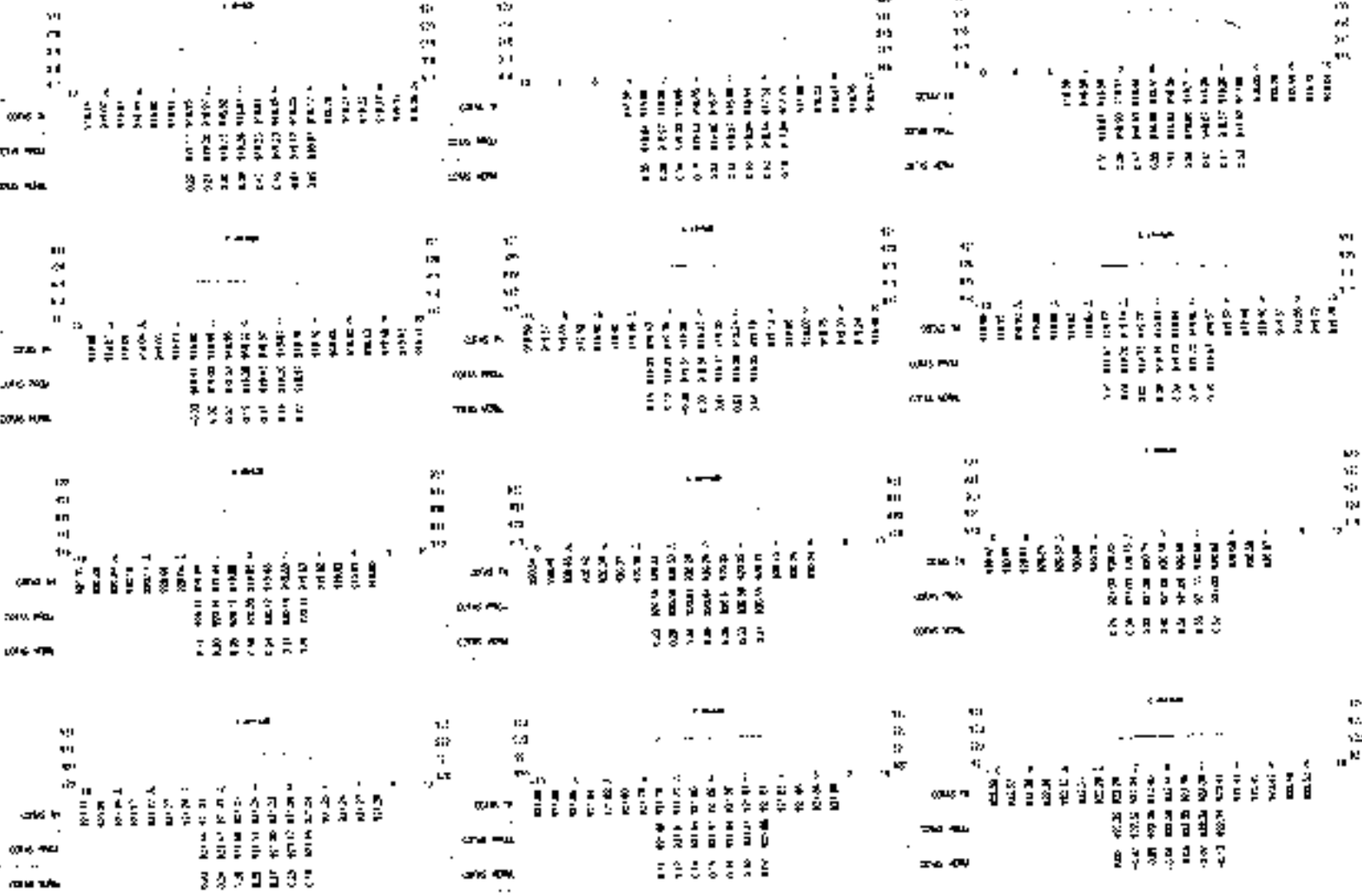

LEGENDA

ATERRO

 CORTA



PREFEITURA MUNICIPAL DE GUARACIABA DO NORTE
 RECUPERAÇÃO DE ESTRADAS VICINAIS NO MUNICÍPIO DE GUARACIABA DO NORTE - CE - Nº 146270-03
 SEÇÕES TRANSVERSAIS

PROJETO	RECUPERAÇÃO DE ESTRADAS VICINAIS NO MUNICÍPIO DE GUARACIABA DO NORTE - CE - Nº 146270-03
CLIENTE	PREFEITURA MUNICIPAL DE GUARACIABA DO NORTE - CE

7 / 08
 1950



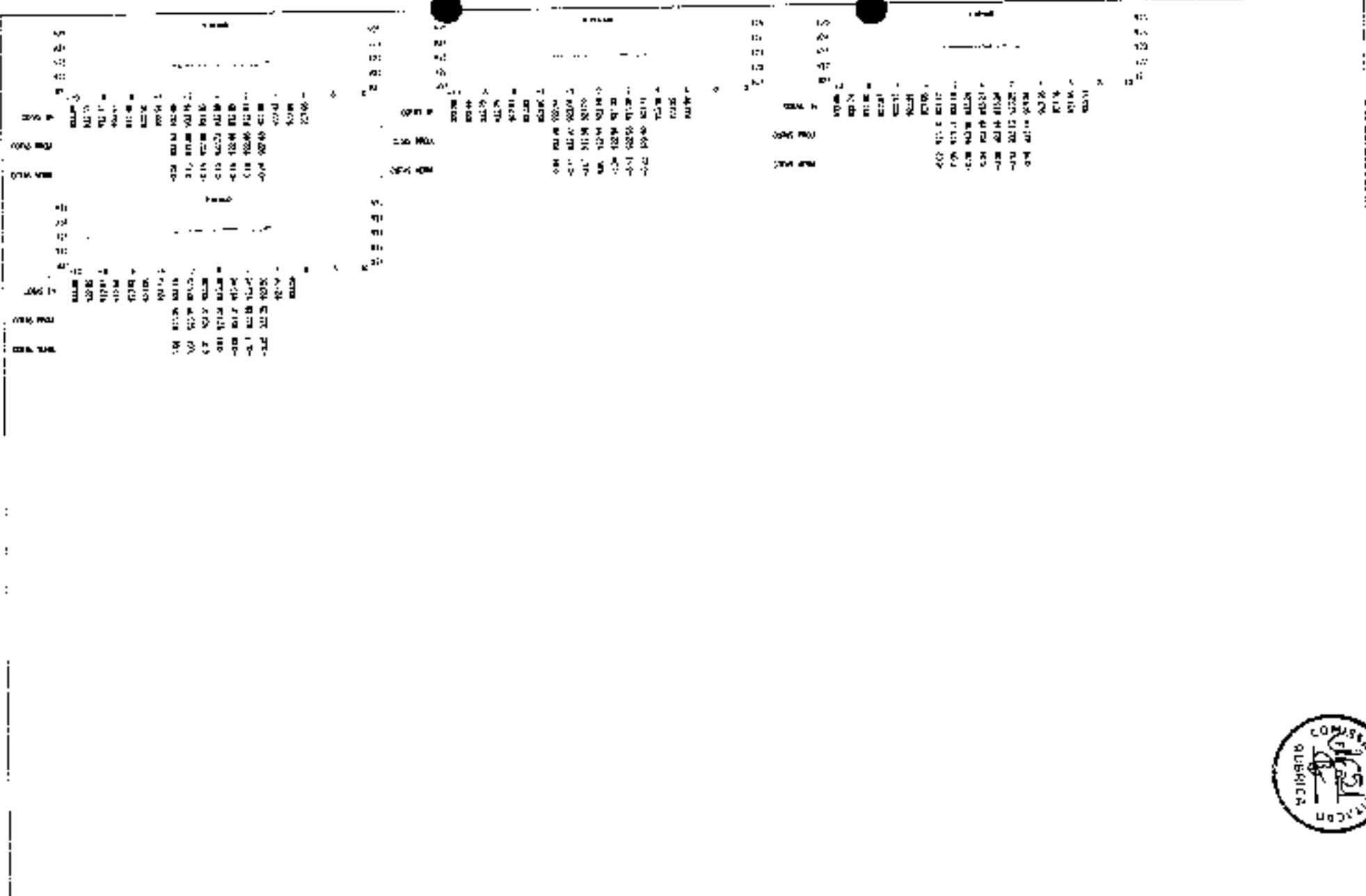

LEGENDA

[Symbol]	ATELADO
[Symbol]	CORTE

<p>JOTA BARRO ARQUITETOS</p>	PREFEITURA MUNICIPAL DE GUARACIABA DO NORTE		8 / 08
	RECUPERAÇÃO DE ESTRADAS VICINAIS NO MUNICÍPIO DE GUARACIABA DO NORTE-UE - FT 1086270-03		
	SEÇÕES TRANSVERSAIS		
	PROJETO	DESENVOLVIDO POR JOTA BARRO ARQUITETOS	DATA
EMPRESA	PROJ. CIVIL E LÍQUIDAÇÃO DE OBRAS		



1. SINAL DE AVISADO



1:1000 70x2



1:1000 20x9

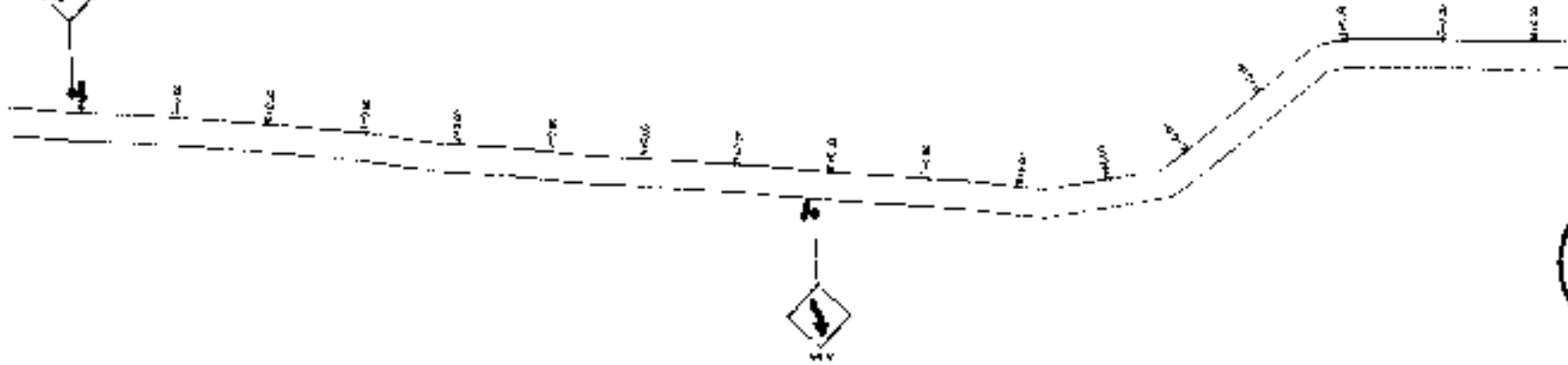

JOTA ENGENHARIA
PROJETO

PREFEITURA MUNICIPAL DE GUARACIABA DO NORTE
RECUPERAÇÃO DE ESTRADAS VICINAIS NO MUNICÍPIO DE GUARACIABA DO NORTE - CE - (CEN 270-03)
SINALIZAÇÃO VIÁRIA

PROJETO DE SINALIZAÇÃO VIÁRIA PARA O PROJETO DE RECUPERAÇÃO DE ESTRADAS VICINAIS NO MUNICÍPIO DE GUARACIABA DO NORTE - CE - (CEN 270-03)

1 / 03
17/000



0 1000 2000

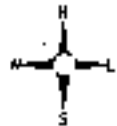

0 1000 2000

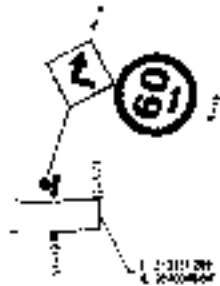
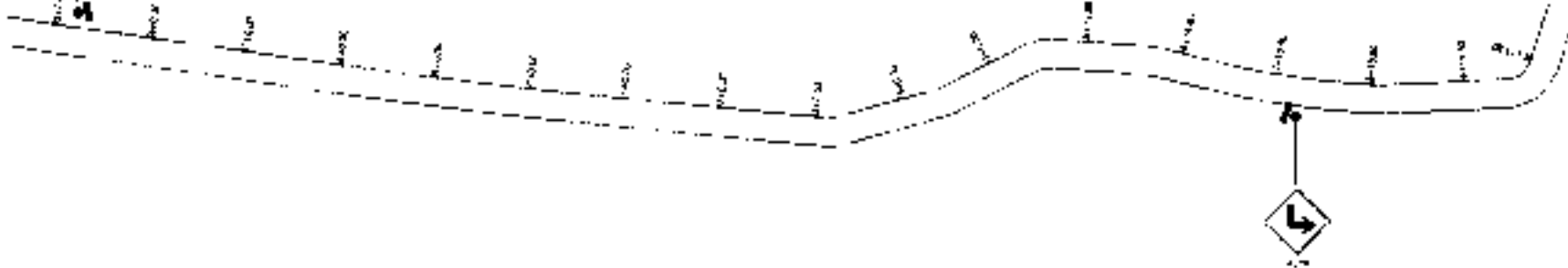

PREFEITURA MUNICIPAL DE GUARACIABA DO NORTE	
RECUPERAÇÃO DE ESTRADAS VICINAIS NO MUNICÍPIO DE GUARACIABA DO NORTE - CE - RT 1086270-03	
SINALIZAÇÃO VIÁRIA	
PROJETO	DESENVOLVIDO POR JOSÉ BARROS PROJETO
APROVADO	EM 15/08/2003 POR RESOLUÇÃO Nº 001/2003

2 / 03
2003

Posicionamento: transversal

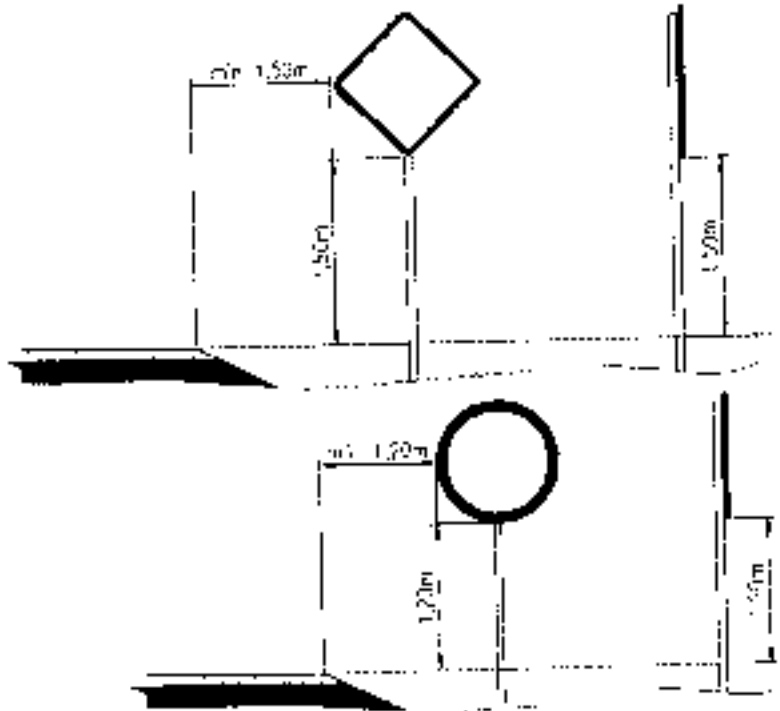

PLACAS DE ADVERTÊNCIA

PLACAS	CODIGO	INDICAÇÃO	QUANTIDADE
	411	60 km/h	01

As Placas de Advertência com as seguintes características:

Material	Cor	Forma	Tamanho
Alumínio	Branco	Redonda	400x400
Alumínio	Branco	Redonda	300x300
Alumínio	Branco	Redonda	200x200
Alumínio	Branco	Redonda	150x150

PLACAS DE ADVERTÊNCIA

PLACAS	CODIGO	INDICAÇÃO	QUANTIDADE
	412	Curva à esquerda	01
	413	Curva à direita	01
	414	Avanço	01

As Placas de Advertência com as seguintes características:

Material	Cor	Forma	Tamanho
Alumínio	Branco	Redonda	400x400
Alumínio	Branco	Redonda	300x300
Alumínio	Branco	Redonda	200x200
Alumínio	Branco	Redonda	150x150



PREFEITURA MUNICIPAL DE GUARACIABA DO NORTE
 REGISTRAÇÃO DE ESTRADAS VICINAIS NO MUNICÍPIO DE GUARACIABA
 DO NORTE-CE - PI 108270-03
 SINALIZAÇÃO VIÁRIA

PROPOSTA	108270-03
MUNICÍPIO	GUARACIABA DO NORTE - CE

3 / 03
 BEN FEE



0 1000 2000

Curva Simétrica

0 10 20 30 40 50 60 70 80 90 100 110 120 130 140 150 160 170 180 190 200

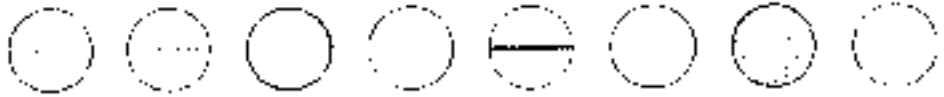

1. CENTRO DA VIA 2. BORDA DA VIA 3. BORDA DA VIA 4. BORDA DA VIA 5. TRANSVERSAL 6. BORDA DA VIA 7. BORDA DA VIA 8. BORDA DA VIA



PREFEITURA MUNICIPAL DE GLARCIADA DO NORTE
 RECUPERAÇÃO DE ESTRADAS VICINAIS NO MUNICÍPIO DE GLARCIADA DO NORTE - CE - Nº 1086278-23
 ESTACQUEAMENTO E PERFIL LONGITUDINAL

PROJETA	ENGENHEIRO RESPONSÁVEL: CARLOS ROCHA
EMPRESA	JOTA BARROS S.R.L.



1 / 10
14/08/2023
17:00



1:4000 2000

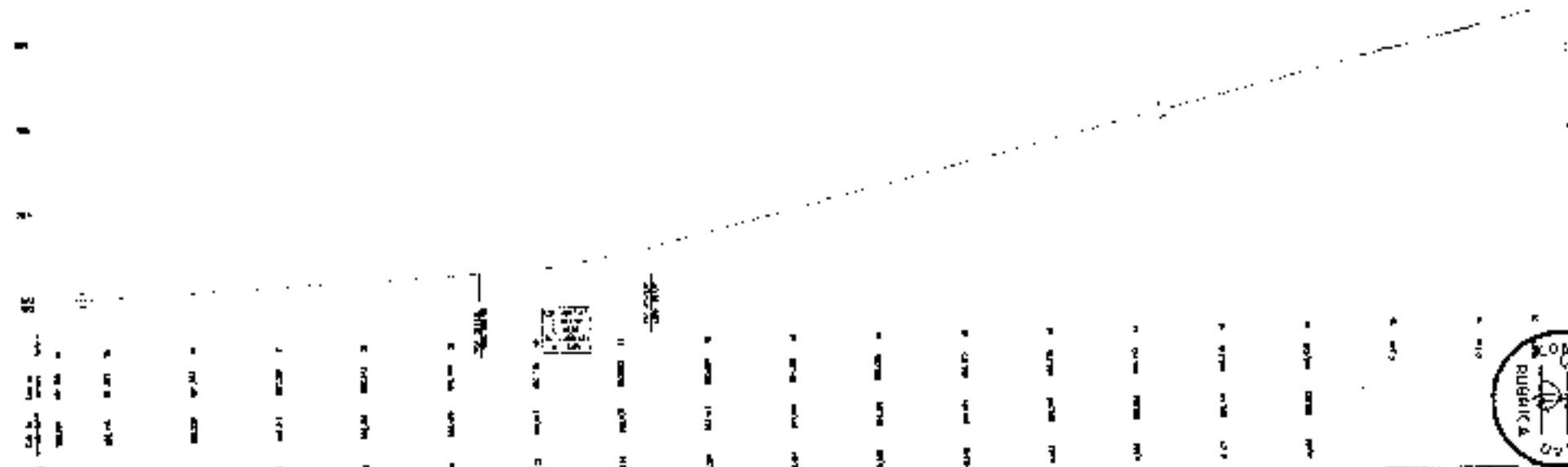

- 
LATERALIZAÇÃO
- 
VITELHA
- 
DRENAGEM
- 
LARGURA
- 
TIPLOGRAFIA
- 
LARGURA
- 
LARGURA
- 
LARGURA DE ROLAMENTO



PREFEITURA MUNICIPAL DE GUARACIABA DO NORTE
 RECUPERAÇÃO DE ESTRADAS VICINAIS NO MUNICÍPIO DE GUARACIABA DO NORTE-CE - PT 1086270-02
 ESTAQUEAMENTO E PERFL LONGITUDINAL
 PROJETO DE: JOTA BARROS ENGENHARIA
 EXECUTADO POR: JOTA BARROS ENGENHARIA



2 / 10
 ESCALA
 1:1000
 1:1000

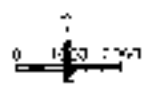

0
20
40
60
80

1
2
3
4
5
6
7
8
9
10
11
12
13
14
15
16
17
18
19
20
21
22
23
24
25
26
27
28
29
30

PROJEÇÃO
TIPO DE PROJEÇÃO
DATUM
ESCALA

LEGENDA

PROJEÇÃO
TIPO DE PROJEÇÃO
DATUM
ESCALA

LEGENDA

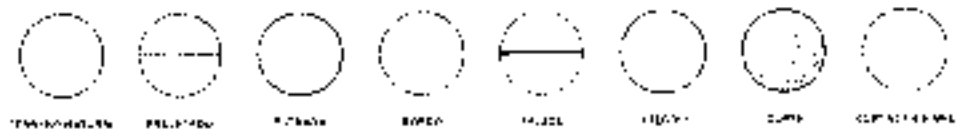

PREFEITURA MUNICIPAL DE GUARACIABA DO NORTE
RECONSTRUÇÃO DE ESTRADAS VICIAIS NO MUNICÍPIO DE GUARACIABA
 (C) NORTE-DE - PT 138527000
ESTAQUEAMENTO E PERFIL LONGITUDINAL
 PROJETO: TRILHA PARA MONTE NORTE - CONSTRUÇÃO DE ESTRADA
 LOCAL: RUA RIBANCA, QUADRA 100, LOTE 100, GUARACIABA DO NORTE



3 / 10
 DATA: 15/06/2010
 VÍZIO

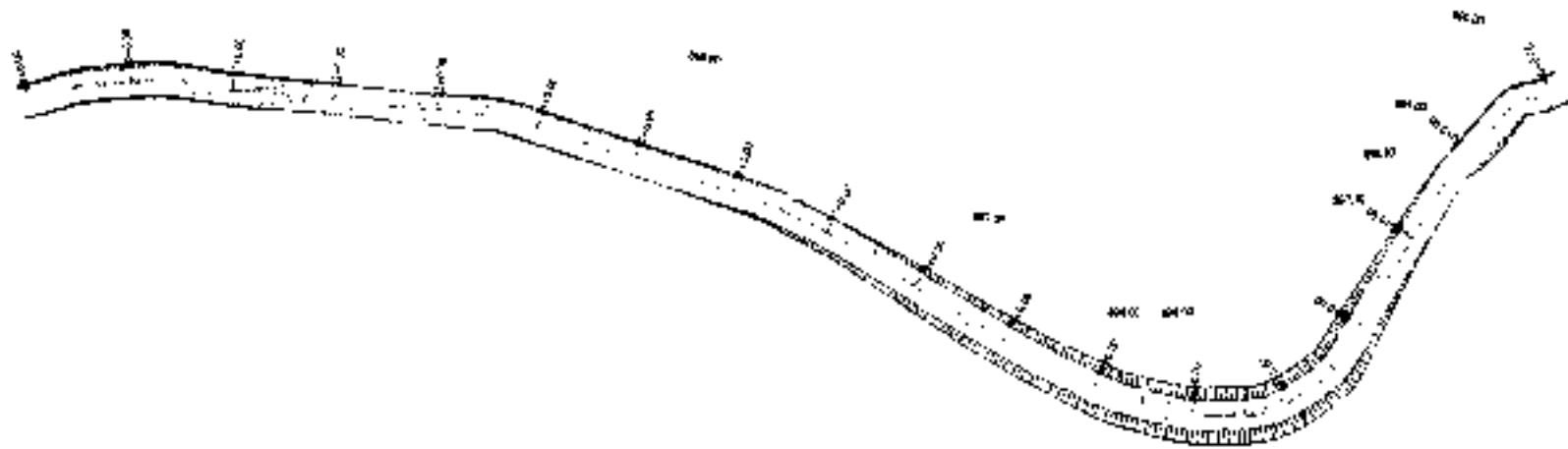
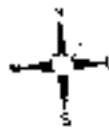

0 1000 2000

0
1
2
3
4
5
6
7
8
9
10
11
12
13
14
15
16
17
18
19
20
21
22
23
24
25
26
27
28
29
30
31
32
33
34
35
36
37
38
39
40
41
42
43
44
45
46
47
48
49
50
51
52
53
54
55

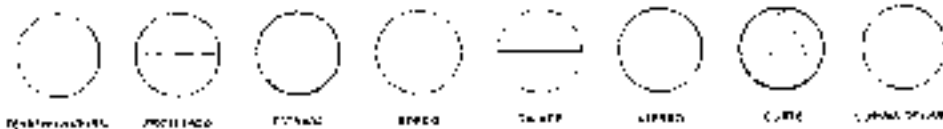

RETENÇÃO DE ÁGUA PROFILADO FÔRMA BORDO TALVEZE ALAMEDA CURVA LINHA DE ÁGUA

7,00 0,00



PROF. 1,00

PROF. 1,00



PROF. 1,00

PROF. 1,00



PREFEITURA MUNICIPAL DE GUARACIABA DO NORTE
 RECUPERAÇÃO DE ESTRADAS VILANAS NO MUNICÍPIO DE GUARACIABA DO NORTE - CE - RT 106070-03
 ESTADQUEAMENTO E PERFIL LONGITUDINAL

PROJETO	ENG. CIVIL ANTONIO MORAES - CREA 17017/00-04
PROJETO	DE MAQUILAGEM DE PROJ. DE MAQUILAGEM

4 / 10

1:5000
V. 1/1

0 100 200

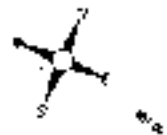

1	2	3	4	5	6	7	8	9	10	11	12	13	14	15	16	17	18	19	20	21	22	23	24	25	26	27	28	29	30	31	32	33	34	35	36	37	38	39	40	41	42	43	44	45	46	47	48	49	50	51	52	53	54	55	56	57	58	59	60	61	62	63	64	65	66	67	68	69	70	71	72	73	74	75	76	77	78	79	80	81	82	83	84	85	86	87	88	89	90	91	92	93	94	95	96	97	98	99	100
---	---	---	---	---	---	---	---	---	----	----	----	----	----	----	----	----	----	----	----	----	----	----	----	----	----	----	----	----	----	----	----	----	----	----	----	----	----	----	----	----	----	----	----	----	----	----	----	----	----	----	----	----	----	----	----	----	----	----	----	----	----	----	----	----	----	----	----	----	----	----	----	----	----	----	----	----	----	----	----	----	----	----	----	----	----	----	----	----	----	----	----	----	----	----	----	----	----	----	-----

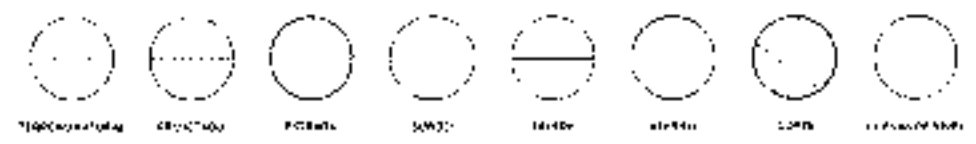

PRÉFECTURA MUNICIPAL DE GUARACIABA DO NORTE
 RECUPERAÇÃO DE ESTRADAS VICINAIS NO MUNICÍPIO DE GUARACIABA DO NORTE - CE - PT 108627003
 ESTAQUEAMENTO E PERFIL LONGITUDINAL
 EXECUTORA: SÓCIEDADE CIVIL ENGENHEIROS OSMAR BRUNO
 PROJETO: DR. FERNANDO DA SILVA - 19/07/2016



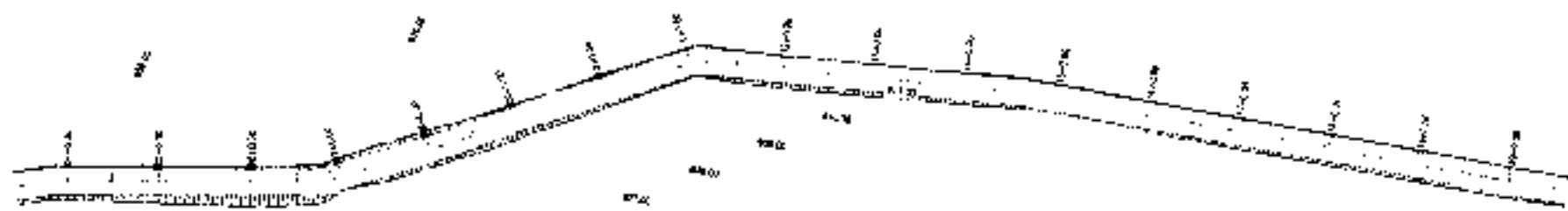

1:1000 20/0

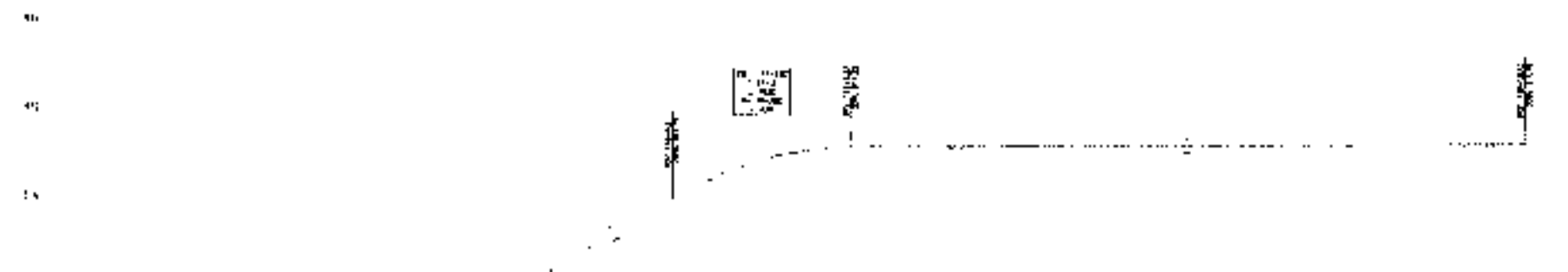

Est.	1+00	2+00	3+00	4+00	5+00	6+00	7+00	8+00	9+00	10+00	11+00	12+00	13+00	14+00	15+00	16+00	17+00	18+00	19+00	20+00
EL. (m)	120.00	118.00	116.00	114.00	112.00	110.00	108.00	106.00	104.00	102.00	100.00	98.00	96.00	94.00	92.00	90.00	88.00	86.00	84.00	82.00
EL. (m)	120.00	118.00	116.00	114.00	112.00	110.00	108.00	106.00	104.00	102.00	100.00	98.00	96.00	94.00	92.00	90.00	88.00	86.00	84.00	82.00
EL. (m)	120.00	118.00	116.00	114.00	112.00	110.00	108.00	106.00	104.00	102.00	100.00	98.00	96.00	94.00	92.00	90.00	88.00	86.00	84.00	82.00
EL. (m)	120.00	118.00	116.00	114.00	112.00	110.00	108.00	106.00	104.00	102.00	100.00	98.00	96.00	94.00	92.00	90.00	88.00	86.00	84.00	82.00
EL. (m)	120.00	118.00	116.00	114.00	112.00	110.00	108.00	106.00	104.00	102.00	100.00	98.00	96.00	94.00	92.00	90.00	88.00	86.00	84.00	82.00
EL. (m)	120.00	118.00	116.00	114.00	112.00	110.00	108.00	106.00	104.00	102.00	100.00	98.00	96.00	94.00	92.00	90.00	88.00	86.00	84.00	82.00
EL. (m)	120.00	118.00	116.00	114.00	112.00	110.00	108.00	106.00	104.00	102.00	100.00	98.00	96.00	94.00	92.00	90.00	88.00	86.00	84.00	82.00
EL. (m)	120.00	118.00	116.00	114.00	112.00	110.00	108.00	106.00	104.00	102.00	100.00	98.00	96.00	94.00	92.00	90.00	88.00	86.00	84.00	82.00
EL. (m)	120.00	118.00	116.00	114.00	112.00	110.00	108.00	106.00	104.00	102.00	100.00	98.00	96.00	94.00	92.00	90.00	88.00	86.00	84.00	82.00
EL. (m)	120.00	118.00	116.00	114.00	112.00	110.00	108.00	106.00	104.00	102.00	100.00	98.00	96.00	94.00	92.00	90.00	88.00	86.00	84.00	82.00

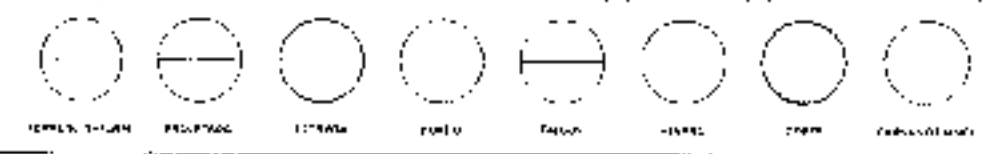

PREFEITURA MUNICIPAL DE GUARACIABA DO NORTE
 RECUPERAÇÃO DE ESTRADAS VICINAIS NO MUNICÍPIO DE GUARACIABA DO NORTE - PE - PT 1086270-02
 ESTACIONAMENTO E PERFIL LONGITUDINAL
 PROJETO: [...]
 EXECUÇÃO: [...]



6 / 10
2021
13/03

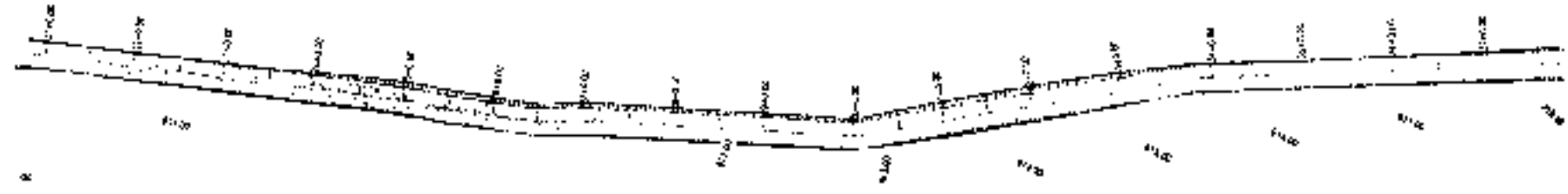

LEGENDA

- 1. CANTO DE ENTRADE
- 2. CANTO DE SAÍDA
- 3. CANTO DE ENTRADE
- 4. CANTO DE SAÍDA
- 5. CANTO DE ENTRADE
- 6. CANTO DE SAÍDA
- 7. CANTO DE ENTRADE
- 8. CANTO DE SAÍDA
- 9. CANTO DE ENTRADE
- 10. CANTO DE SAÍDA
- 11. CANTO DE ENTRADE
- 12. CANTO DE SAÍDA
- 13. CANTO DE ENTRADE
- 14. CANTO DE SAÍDA
- 15. CANTO DE ENTRADE
- 16. CANTO DE SAÍDA
- 17. CANTO DE ENTRADE
- 18. CANTO DE SAÍDA
- 19. CANTO DE ENTRADE
- 20. CANTO DE SAÍDA



PREFEITURA MUNICIPAL DE GUARACIABA DO NORTE
 RECUPERAÇÃO DE ESTRADAS VICINAIS NO MUNICÍPIO DE GUARACIABA DO NORTE - CE - FT 108570-03
ESTAQUEAMENTO E PERFIL LONGITUDINAL
 PROJETO: PRO. 001/2011/SECRETARIA MUNICIPAL DE OBRAS
 AUTORIZADO: CARLOS EDUARDO DE MOURA SILVA



Nº 7110
 11/11/2011
 J. P. S.

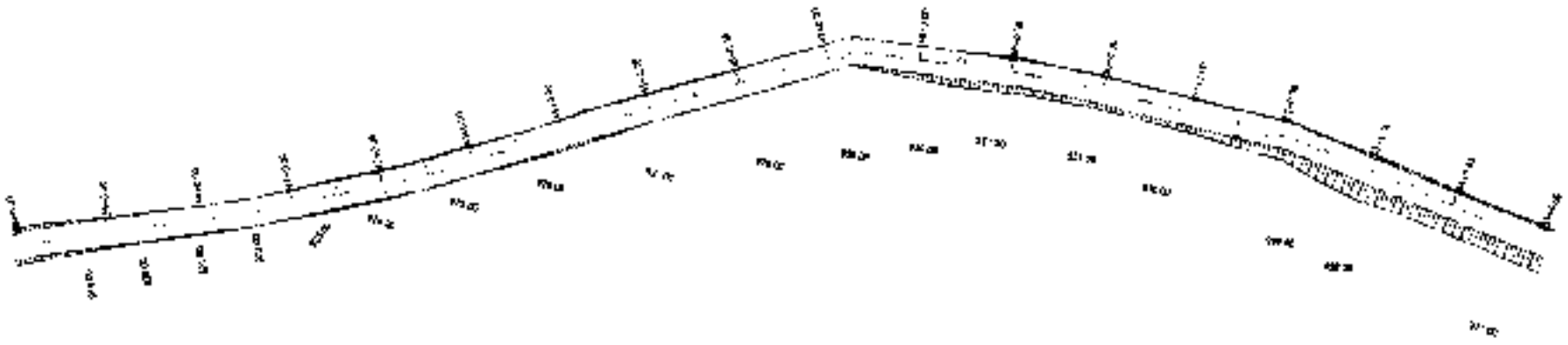

1:1000 2000



1	2	3	4	5	6	7	8	9	10	11	12	13	14	15	16	17	18	19	20
0+00	0+20	0+40	0+60	0+80	1+00	1+20	1+40	1+60	1+80	2+00	2+20	2+40	2+60	2+80	3+00	3+20	3+40	3+60	3+80
10.00	10.50	11.00	11.50	12.00	12.50	13.00	13.50	14.00	14.50	15.00	15.50	16.00	16.50	17.00	17.50	18.00	18.50	19.00	19.50

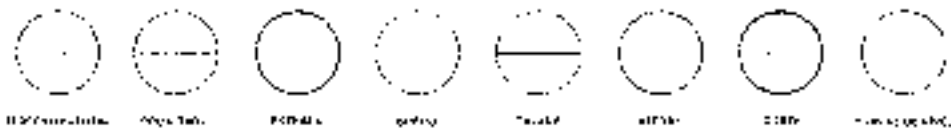

PREFEITURA MUNICIPAL DE GUARACIABA DO NORTE	
RECUPERAÇÃO DE ESTRADAS VICINIAS NO MUNICÍPIO DE GUARACIABA DO NORTE-CE - PT 1085270-03	
ESTAQUEAMENTO E PERFIL LONGITUDINAL	
PROJETO	DR. CELSO MENDES SOARES RODRIGUES S. A. S. JUNIOR
APROVADO	DR. ANDRÉ DE F. M. SOARES S. A. S. JUNIOR



8 / 10



0 500 1000

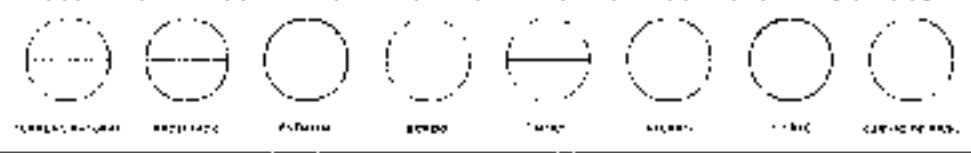
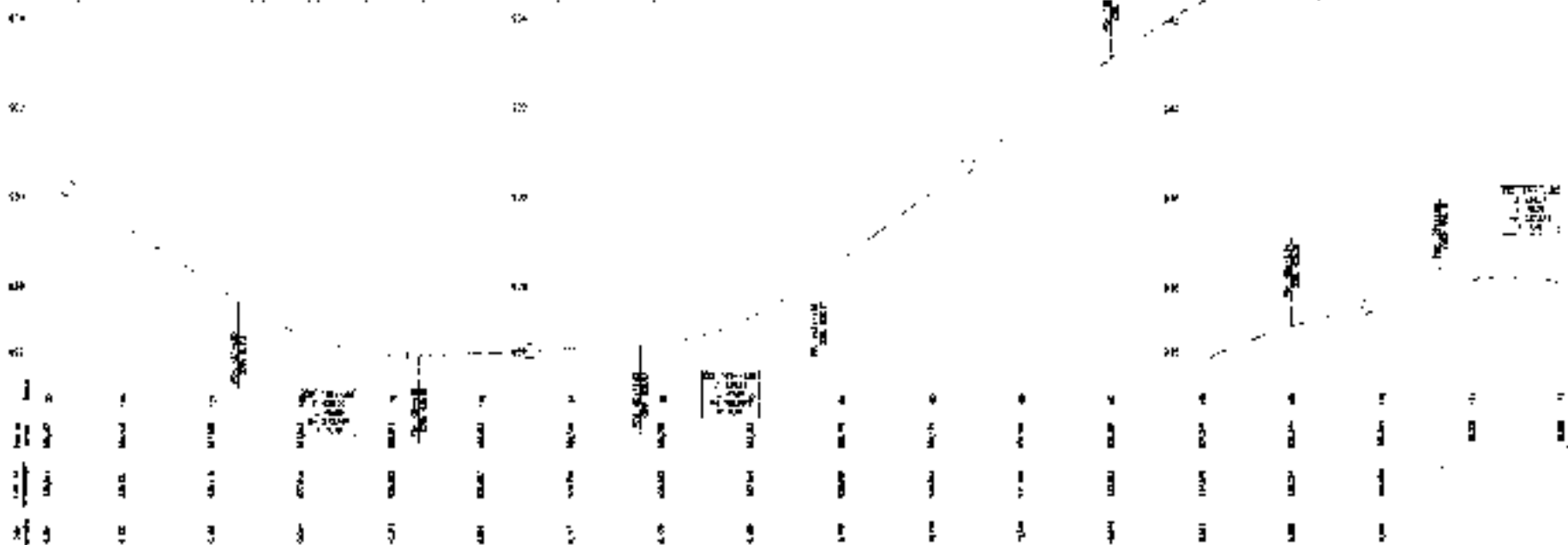
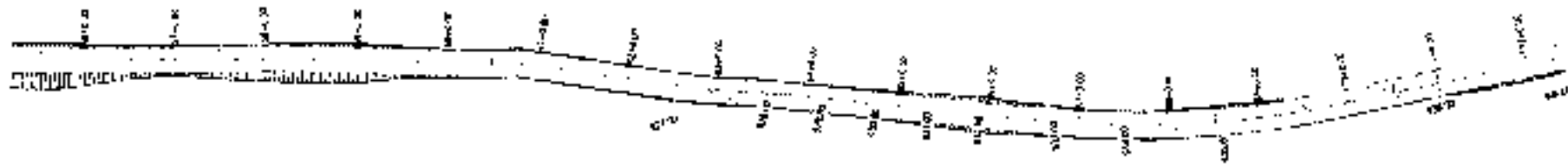

PREFEITURA MUNICIPAL DE GUARACIABA DO NORTE RECUPERAÇÃO DE ESTRADAS VICINAIS NO MUNICÍPIO DE GUARACIABA DO NORTE-CE - PT 106570-03		Nº 9 / 10
ESTAQUEAMENTO E PERFIL LONGITUDINAL		FOLHA Nº 001 DE 001
PROJEÇÃO: UTM ESCALA: 1:5000	DATA: 10/05/2011	AUTOR:





0 1000 2000

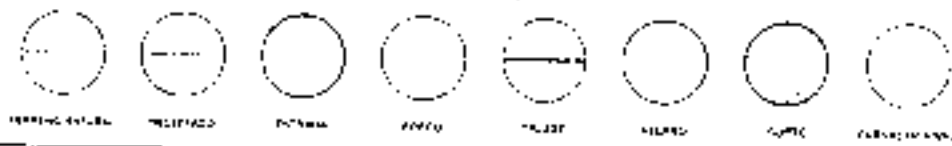
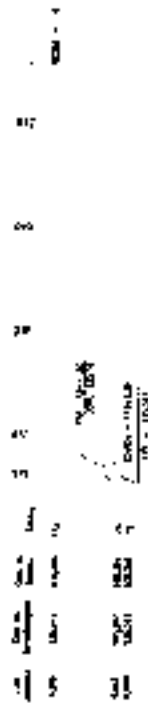

	PREFEITURA MUNICIPAL DE GUARACIABA DO NORTE RECUPERAÇÃO DE ESTRADAS MUNICIPAIS NO MUNICÍPIO DE GUARACIABA DO NORTE - CE - Nº 1086270-03		10 / 10
	ESTAQUEAMENTO E PERFIL LONGITUDINAL		
PROJETO DE	<small>PROJ. ENG. CIVIL CARLOS ALBERTO DE SOUZA JUNIOR</small>		
REVISADO	<small>MR. FÁBIO AUGUSTO DE SOUZA JUNIOR</small>		

Lote nº		Área (m²)		Valor (R\$)		Observações	
Antes	Depois	Antes	Depois	Antes	Depois	Antes	Depois
001-1	001-1	100	100	100	100
002-1	002-1	100	100	100	100
003-1	003-1	100	100	100	100
004-1	004-1	100	100	100	100
005-1	005-1	100	100	100	100
006-1	006-1	100	100	100	100
007-1	007-1	100	100	100	100
008-1	008-1	100	100	100	100
009-1	009-1	100	100	100	100
010-1	010-1	100	100	100	100
011-1	011-1	100	100	100	100
012-1	012-1	100	100	100	100
013-1	013-1	100	100	100	100
014-1	014-1	100	100	100	100
015-1	015-1	100	100	100	100
016-1	016-1	100	100	100	100
017-1	017-1	100	100	100	100
018-1	018-1	100	100	100	100
019-1	019-1	100	100	100	100
020-1	020-1	100	100	100	100

LEGENDA

ATERRO

CORTE



PREFEITURA MUNICIPAL DE GUARACIABA DO NORTE

REGISTRAÇÃO DE CANTAREIS VICINAIS AO MUNICÍPIO DE GUARACIABA DO NORTE - CE - PT 139579-03



SÉCÇÃO TRIBUTÁRIA



1001 BRAS

Endereço: Rua ... nº ...
 CEP: ...
 Telefone: ...

LEGENDA

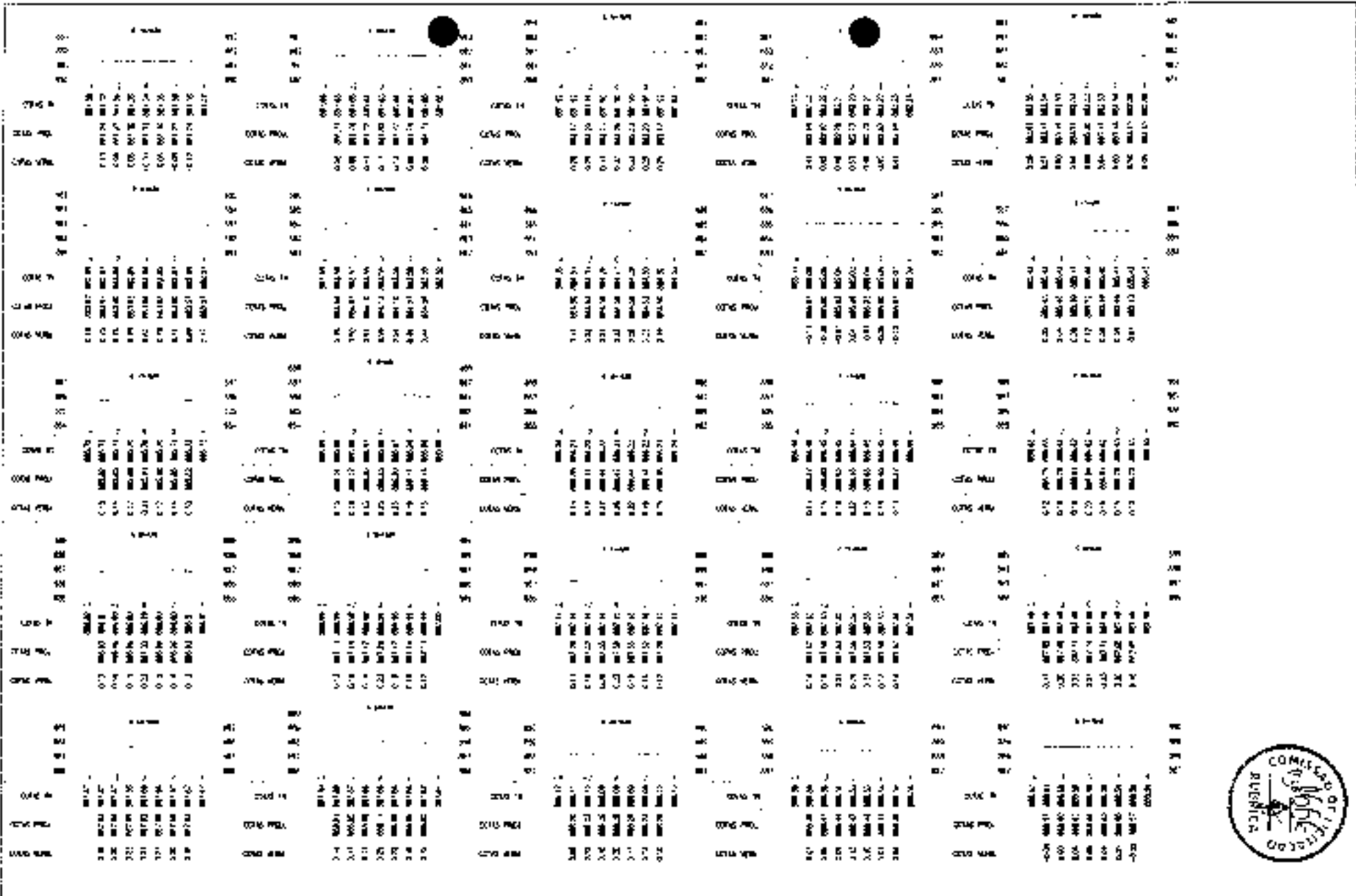

-  ATERRO
-  EXISTE



PREFEITURA MUNICIPAL DE GUARACIABA DO NORTE RECUPERAÇÃO DE ESTRADAS VICINAIS NO MUNICÍPIO DE GUARACIABA DO NORTE-CE - PT 108670-03 SEÇÕES TRANSVERSAIS	
PROJETO	DR. JOSÉ ARIANA MONTES TORRES - LUIZ CARLOS
PROPOSTA	WWW.CNPQ.ORG.BR/PROJETO



LEGENDA

-  ATERRO
-  DRYT

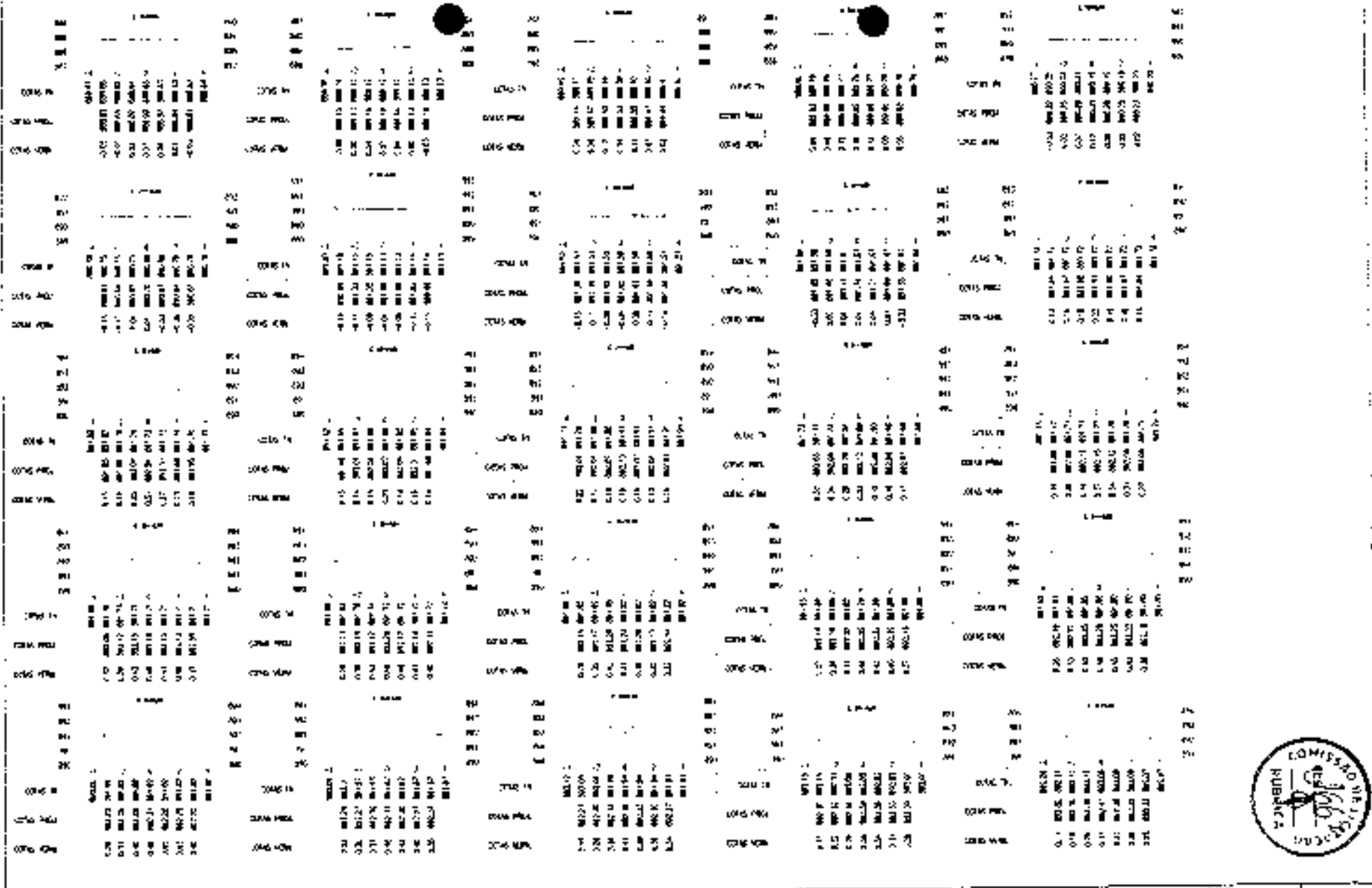



PREFEITURA MUNICIPAL DE GUARACABA DO NORTE RECUPERAÇÃO DE ESTRADAS VIZINHAS AO MUNICÍPIO DE GUARACABA DO NORTE-CE - PI 1086270-01 BLOCOS TRANSVERSAIS		3 / 15
PROJETO:	RECUPERAÇÃO DE ESTRADAS VIZINHAS AO MUNICÍPIO DE GUARACABA DO NORTE-CE - PI 1086270-01	
PROPOSTA:	MADEIRA PARA OBRAS DE RECONSTRUÇÃO DE ESTRADAS	

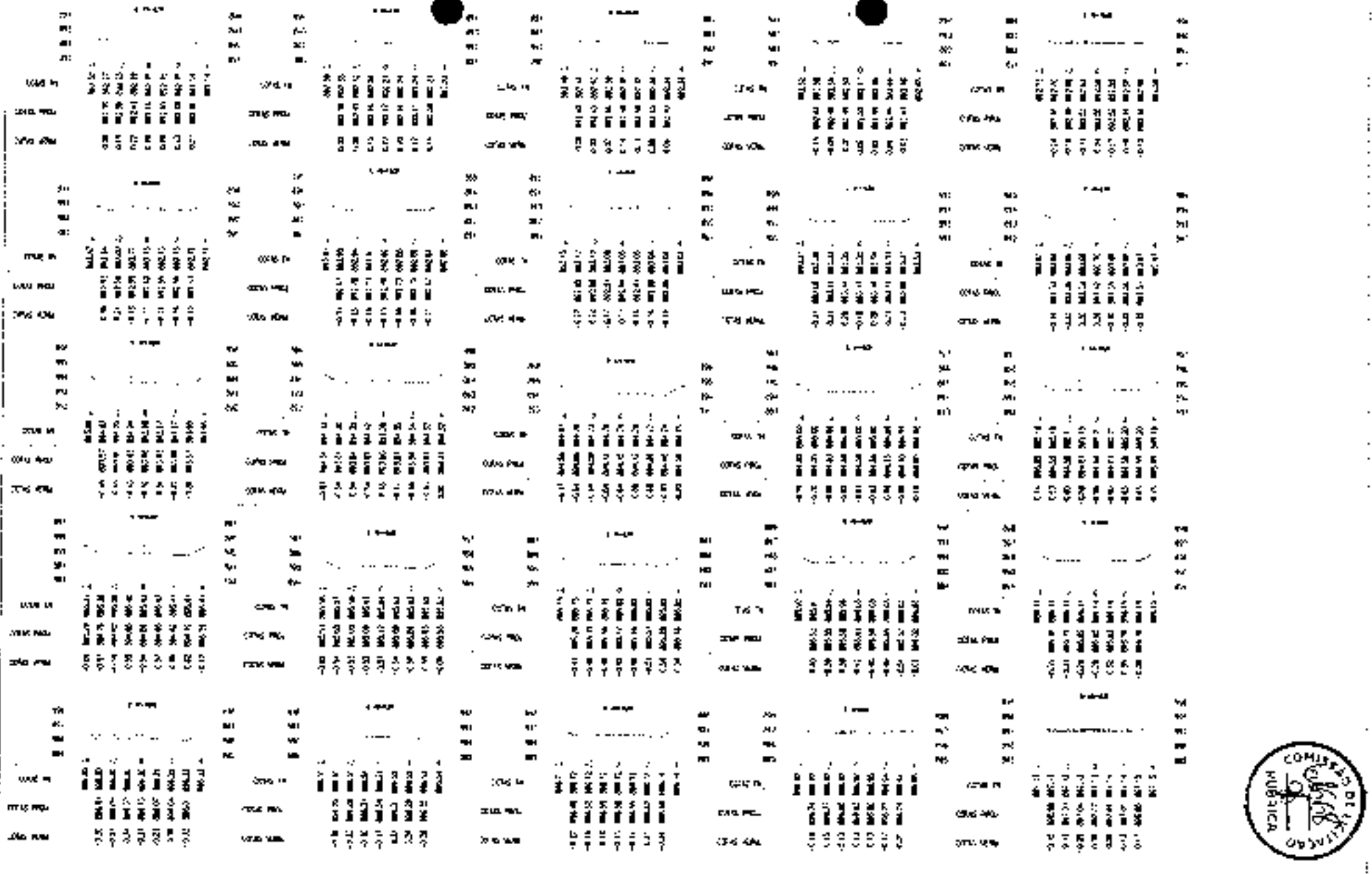

LEGENDA

-  ATERRO
-  CORTE





PREFEITURA MUNICIPAL DE GUARACIABA DO NORTE

RECUPERAÇÃO DE ESTRADAS VICINAS NO MUNICÍPIO DE GUARACIABA DO NORTE-CE - PT. 109-078-01

SEÇÕES TRANSVERSAIS

PROJETO: []

PROFESSOR: []

4 / 15

1:250



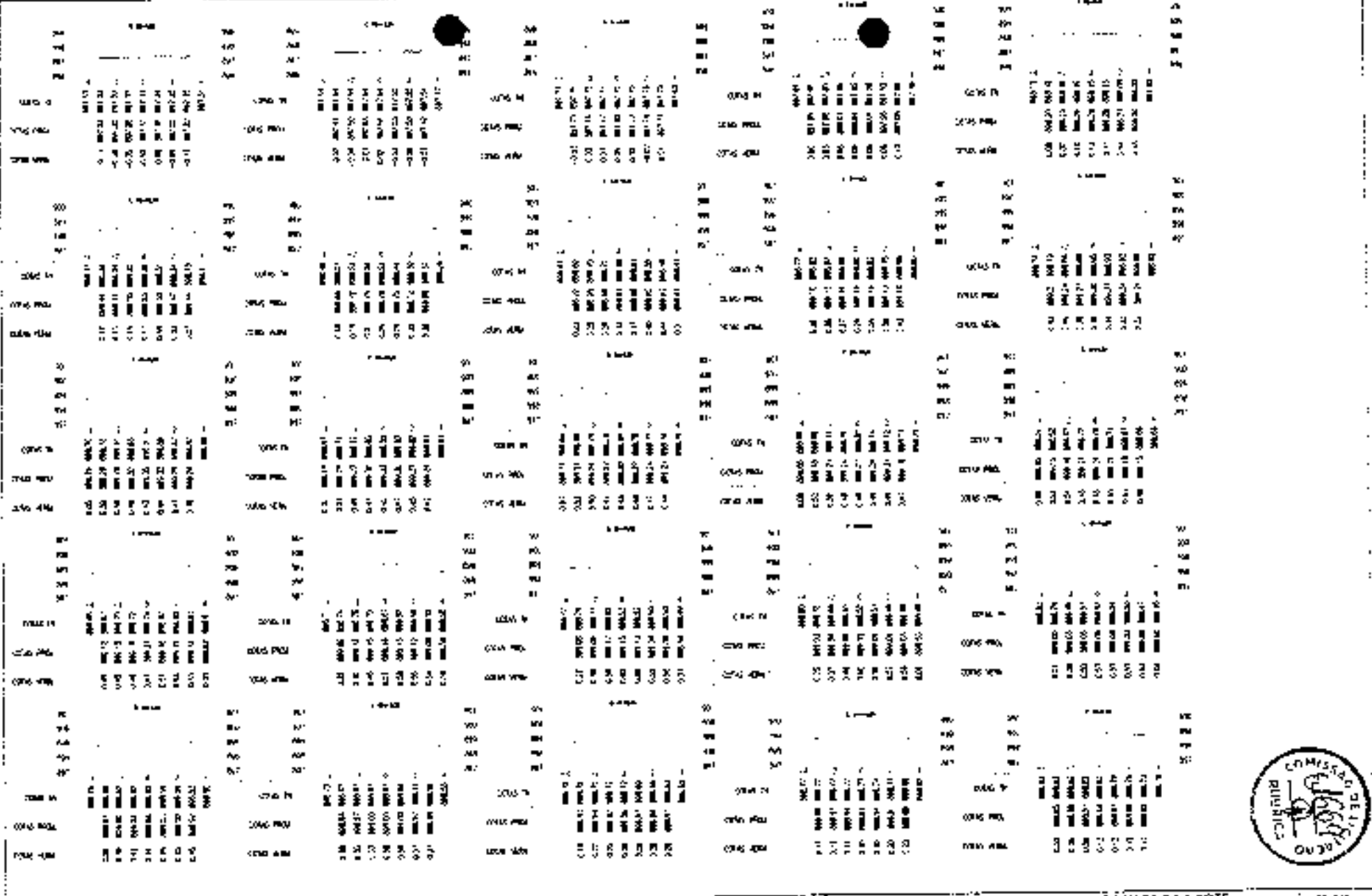

LEGENDA



 <p>JOTA BARROS Engenharia</p>	<p>PREFEITURA MUNICIPAL DE GUARACIABA DO NORTE</p> <p>RECUPERAÇÃO DE ESTRADAS VICINAIS NO MUNICÍPIO DE GUARACIABA DO NORTE-CE - ET 10852/0-00</p> <p>SEÇÃO TRANSVERSA</p>		<p>5 / 15</p>
	<p>PROJETO DE RECUPERAÇÃO DE ESTRADAS VICINAIS</p> <p>Scale: 1:100</p>		<p>1050</p>



LEGENDA

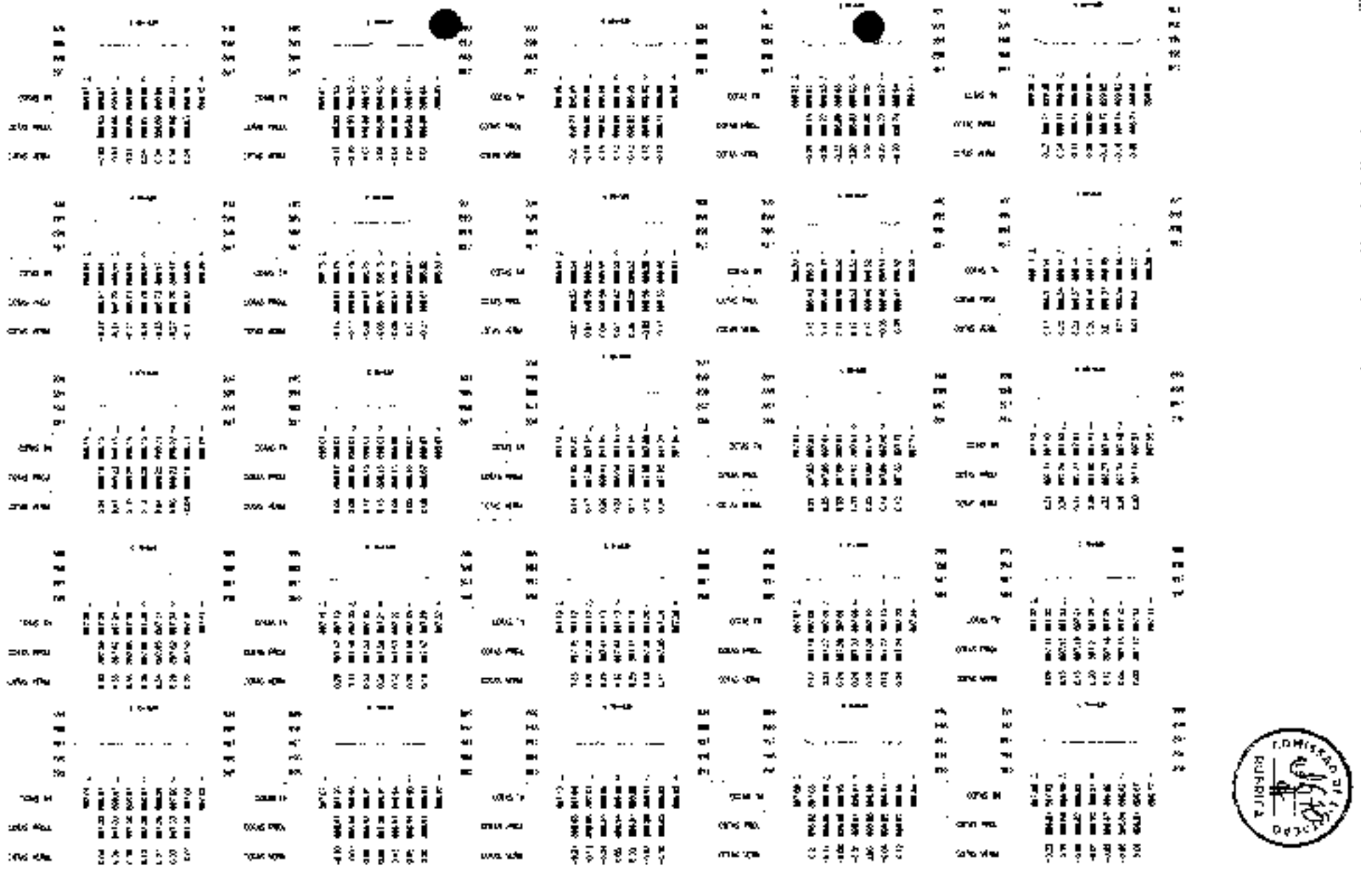

-  ATERRO
-  CORTE





PREFEITURA MUNICIPAL DE GUARACIABA DO NORTE RECUPERAÇÃO DE ESTRADAS VICINAIS NO MUNICÍPIO DE GUARACIABA DO NORTE - CE - FT 108527D-01 SEÇÕES TRANSVERSAIS		Nº: 6 / 15 Data: 1/2006
PROJETO:	PROJ. DE OBRAS DE RECONSTRUÇÃO DE VIAS URBANAS	
PROGRAMA:	PROJ. DE OBRAS DE RECONSTRUÇÃO DE VIAS URBANAS	

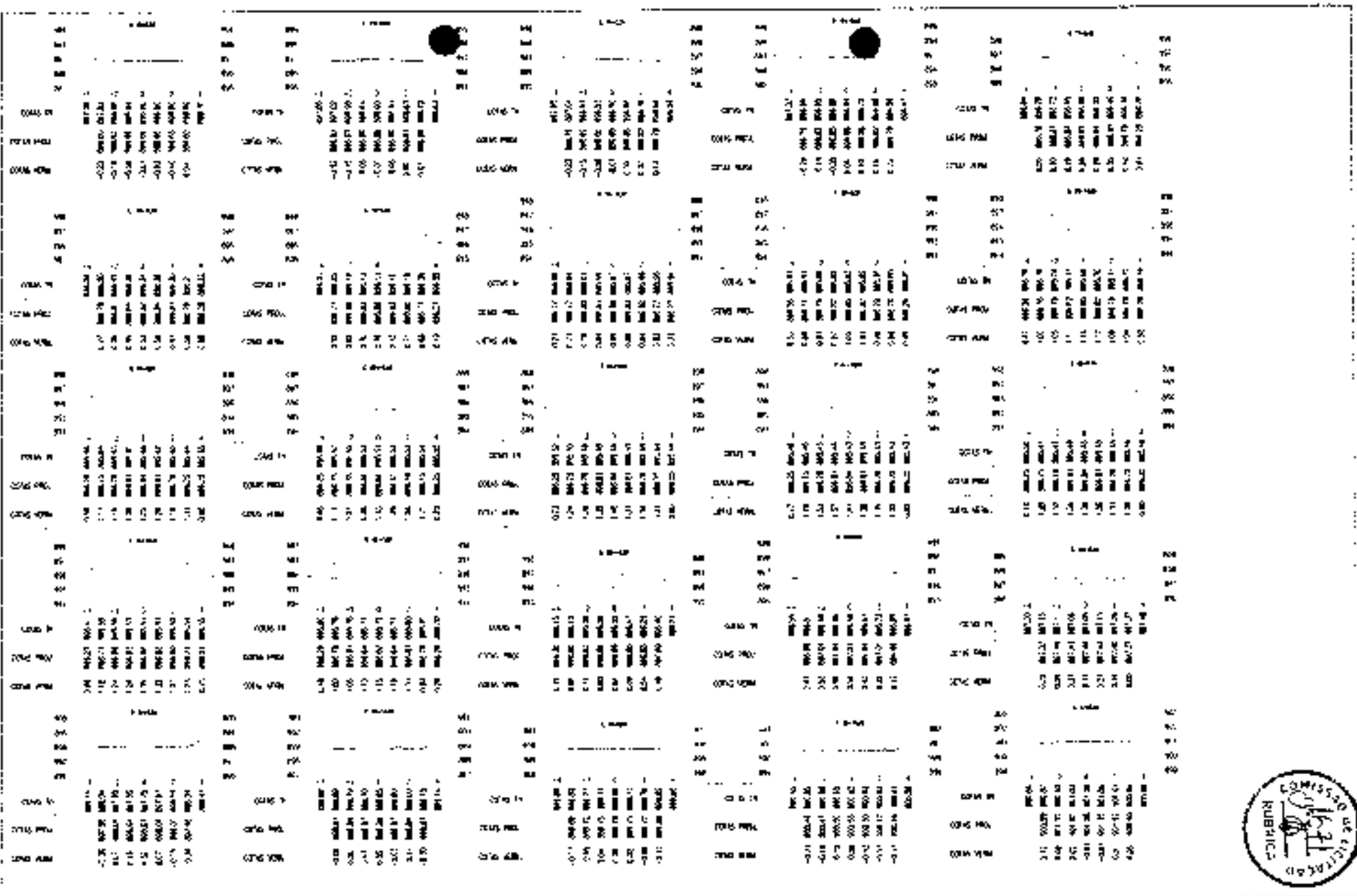

LEGENDA

-  ATERRÇO
-  LIMITE



	PREFEITURA MUNICIPAL DE GLARACIAMA DO NORTE		7 / 15
	RECLPERAÇÃO DE ESTRAÇAS UICIAIS NO MUNICÍPIO DE GLARACIAMA DO NORTE-CE - PT 100627003		
	SEÇÃO TRANSVERSA B		
	PROJETO DE RECLPERAÇÃO DE ESTRAÇAS UICIAIS NO MUNICÍPIO DE GLARACIAMA DO NORTE-CE - PT 100627003		
AUTOR: [unreadable]		1/2020	



LEGENDA

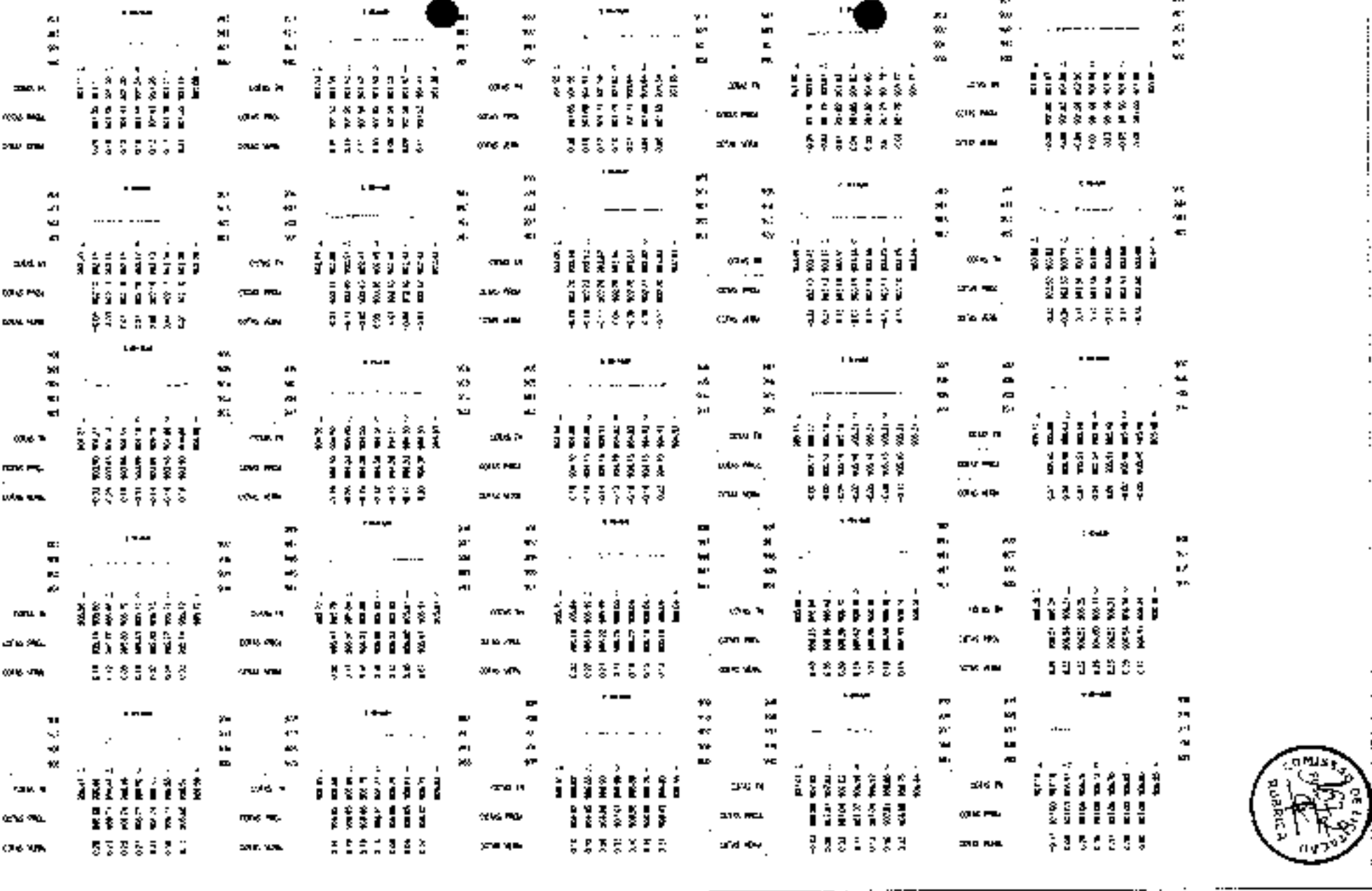
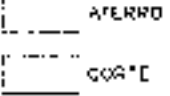

PREFEITURA MUNICIPAL DE GUARACABA DO NORTE
RESOLUÇÃO DE ESTRADAS VICINAIS NO MUNICÍPIO DE GUARACABA DO NORTE-CE - FT 108270/80
SEÇÕES TRANSVERSAIS

CONTEÚDO: PLANO DE ALINHAMENTO, TERMO DE ABERTURA DE OBRAS
AUTORIZADO: PARECERES DA COMISSÃO DE LICITAÇÃO





PREFEITURA MUNICIPAL DE GUARACIABA DO NORTE
REGISTRO DE PREÇOS Nº 001/2015
DO NICH 15-06 - PT 106627040
BOMBEIROS TRANSFERIDOS

ATA Nº 001/2015
DATA: 09/07/2015

15/07/2015



LEGENDA

ALIENIO

CORTE

Item	Descrição	Valor	Item	Descrição	Valor
001	001
002	002
003	003
004	004
005	005
006	006
007	007
008	008
009	009
010	010
011	011
012	012
013	013
014	014
015	015
016	016
017	017
018	018
019	019
020	020
021	021
022	022
023	023
024	024
025	025
026	026
027	027
028	028
029	029
030	030
031	031
032	032
033	033
034	034
035	035
036	036
037	037
038	038
039	039
040	040
041	041
042	042
043	043
044	044
045	045
046	046
047	047
048	048
049	049
050	050
051	051
052	052
053	053
054	054
055	055
056	056
057	057
058	058
059	059
060	060
061	061
062	062
063	063
064	064
065	065
066	066
067	067
068	068
069	069
070	070
071	071
072	072
073	073
074	074
075	075
076	076
077	077
078	078
079	079
080	080
081	081
082	082
083	083
084	084
085	085
086	086
087	087
088	088
089	089
090	090
091	091
092	092
093	093
094	094
095	095
096	096
097	097
098	098
099	099
100	100

QUANTIDADE	VALOR UNITARIO	VALOR TOTAL	EMPRESA	INSCRIÇÃO ESTADUAL	INSCRIÇÃO MUNICIPAL
100	100,00	10000,00	CONSTRUTORA S.A.	12345678	98765432
200	50,00	10000,00	CONSTRUTORA S.A.	12345678	98765432
300	33,33	10000,00	CONSTRUTORA S.A.	12345678	98765432
400	25,00	10000,00	CONSTRUTORA S.A.	12345678	98765432
500	20,00	10000,00	CONSTRUTORA S.A.	12345678	98765432

QUANTIDADE	VALOR UNITARIO	VALOR TOTAL	EMPRESA	INSCRIÇÃO ESTADUAL	INSCRIÇÃO MUNICIPAL
100	100,00	10000,00	CONSTRUTORA S.A.	12345678	98765432
200	50,00	10000,00	CONSTRUTORA S.A.	12345678	98765432
300	33,33	10000,00	CONSTRUTORA S.A.	12345678	98765432
400	25,00	10000,00	CONSTRUTORA S.A.	12345678	98765432
500	20,00	10000,00	CONSTRUTORA S.A.	12345678	98765432

QUANTIDADE	VALOR UNITARIO	VALOR TOTAL	EMPRESA	INSCRIÇÃO ESTADUAL	INSCRIÇÃO MUNICIPAL
100	100,00	10000,00	CONSTRUTORA S.A.	12345678	98765432
200	50,00	10000,00	CONSTRUTORA S.A.	12345678	98765432
300	33,33	10000,00	CONSTRUTORA S.A.	12345678	98765432
400	25,00	10000,00	CONSTRUTORA S.A.	12345678	98765432
500	20,00	10000,00	CONSTRUTORA S.A.	12345678	98765432

QUANTIDADE	VALOR UNITARIO	VALOR TOTAL	EMPRESA	INSCRIÇÃO ESTADUAL	INSCRIÇÃO MUNICIPAL
100	100,00	10000,00	CONSTRUTORA S.A.	12345678	98765432
200	50,00	10000,00	CONSTRUTORA S.A.	12345678	98765432
300	33,33	10000,00	CONSTRUTORA S.A.	12345678	98765432
400	25,00	10000,00	CONSTRUTORA S.A.	12345678	98765432
500	20,00	10000,00	CONSTRUTORA S.A.	12345678	98765432

QUANTIDADE	VALOR UNITARIO	VALOR TOTAL	EMPRESA	INSCRIÇÃO ESTADUAL	INSCRIÇÃO MUNICIPAL
100	100,00	10000,00	CONSTRUTORA S.A.	12345678	98765432
200	50,00	10000,00	CONSTRUTORA S.A.	12345678	98765432
300	33,33	10000,00	CONSTRUTORA S.A.	12345678	98765432
400	25,00	10000,00	CONSTRUTORA S.A.	12345678	98765432
500	20,00	10000,00	CONSTRUTORA S.A.	12345678	98765432



LEGENDA

ALICATOR

CONTE

PREFEITURA MUNICIPAL DE GUARACIARA DO NORTE

RECUPERAÇÃO DE ESTRADAS VICINAIS DO MUNICÍPIO DE GUARACIARA DO NORTE-CE - PT. 103270-03

SEÇÃO TRANSPORTES

10 / 15

12522

Item	Descrição	Quantidade	Valor Unitário	Valor Total
1.1	...	100
1.2	...	200
1.3	...	300
1.4	...	400
1.5	...	500
1.6	...	600
1.7	...	700
1.8	...	800
1.9	...	900
1.10	...	1000
1.11	...	1100
1.12	...	1200
1.13	...	1300
1.14	...	1400
1.15	...	1500
1.16	...	1600
1.17	...	1700
1.18	...	1800
1.19	...	1900
1.20	...	2000



PREFEITURA MUNICIPAL DE GUARACIABA DO NORTE
RECUPERAÇÃO DE ESTRADAS VICINAIS DO MUNICÍPIO DE GUARACIABA DO NORTE-CE - FT. 08657003

SEÇÕES TRANSVERSAIS

ATERRO

CORTE

11 / 15



16296

COMISSÃO DE LICITAÇÃO PÚBLICA
 Nº 001/2010
 DATA DE ABERTURA: 24/06/2010
 HORARIO: 14h30min



SECRETARIA MUNICIPAL DE SAÚDE
 PREFEITURA MUNICIPAL DE GUARACIABA DO NORTE
 RECUPERAÇÃO DE ESTRADAS VICINAIS NO MUNICÍPIO DE GUARACIABA DO NORTE - PE - 109-070-03
 SEÇÃO TREINAMENTO
 Nº 001/2010
 DATA DE ABERTURA: 24/06/2010
 HORARIO: 14h30min

13/15

Item	Descrição	Quantidade	Valor Unitário	Valor Total
01	...	100
02	...	200
03	...	300
04	...	400
05	...	500
TOTAL GERAL				

Item	Descrição	Quantidade	Valor Unitário	Valor Total
06	...	100
07	...	200
08	...	300
09	...	400
10	...	500
TOTAL GERAL				

Item	Descrição	Quantidade	Valor Unitário	Valor Total
11	...	100
12	...	200
13	...	300
14	...	400
15	...	500
TOTAL GERAL				

Item	Descrição	Quantidade	Valor Unitário	Valor Total
16	...	100
17	...	200
18	...	300
19	...	400
20	...	500
TOTAL GERAL				

Item	Descrição	Quantidade	Valor Unitário	Valor Total
21	...	100
22	...	200
23	...	300
24	...	400
25	...	500
TOTAL GERAL				

ATENÇÃO

CONTINUA

Quilômetro	Estação	Quilômetro	Estação	Quilômetro	Estação
10	Estação 1	20	Estação 2	30	Estação 3
20	Estação 4	30	Estação 5	40	Estação 6
30	Estação 7	40	Estação 8	50	Estação 9
40	Estação 10	50	Estação 11	60	Estação 12
50	Estação 13	60	Estação 14	70	Estação 15
60	Estação 16	70	Estação 17	80	Estação 18
70	Estação 19	80	Estação 20	90	Estação 21
80	Estação 22	90	Estação 23	100	Estação 24

Quilômetro	Estação	Quilômetro	Estação	Quilômetro	Estação
10	Estação 1	20	Estação 2	30	Estação 3
20	Estação 4	30	Estação 5	40	Estação 6
30	Estação 7	40	Estação 8	50	Estação 9
40	Estação 10	50	Estação 11	60	Estação 12
50	Estação 13	60	Estação 14	70	Estação 15
60	Estação 16	70	Estação 17	80	Estação 18
70	Estação 19	80	Estação 20	90	Estação 21
80	Estação 22	90	Estação 23	100	Estação 24

Quilômetro	Estação	Quilômetro	Estação	Quilômetro	Estação
10	Estação 1	20	Estação 2	30	Estação 3
20	Estação 4	30	Estação 5	40	Estação 6
30	Estação 7	40	Estação 8	50	Estação 9
40	Estação 10	50	Estação 11	60	Estação 12
50	Estação 13	60	Estação 14	70	Estação 15
60	Estação 16	70	Estação 17	80	Estação 18
70	Estação 19	80	Estação 20	90	Estação 21
80	Estação 22	90	Estação 23	100	Estação 24

Quilômetro	Estação	Quilômetro	Estação	Quilômetro	Estação
10	Estação 1	20	Estação 2	30	Estação 3
20	Estação 4	30	Estação 5	40	Estação 6
30	Estação 7	40	Estação 8	50	Estação 9
40	Estação 10	50	Estação 11	60	Estação 12
50	Estação 13	60	Estação 14	70	Estação 15
60	Estação 16	70	Estação 17	80	Estação 18
70	Estação 19	80	Estação 20	90	Estação 21
80	Estação 22	90	Estação 23	100	Estação 24

LEGENDA

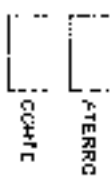

PREFEITURA MUNICIPAL DE GUARACIABA DO NORTE
RECUPERAÇÃO DE ESTRADAS VICINAIS NO MUNICÍPIO DE GUARACIABA
DO NORTE - PR 100027003
SEÇÃO DE TRANSPORTES



AVULSO
 Nº 14 / 15
 14 / 15



PREFEITURA MUNICIPAL DE GUARACIABA DO NORTE
 RECONSTRUÇÃO DE ESTRADAS MUNICIPAIS NO MUNICÍPIO DE GUARACIABA DO NORTE DE PT: 086270/03
 SEÇÕES TRANSVERSAIS

15 / 15
 1050

LEGENDA
 [] ATERRO
 [] CORTI

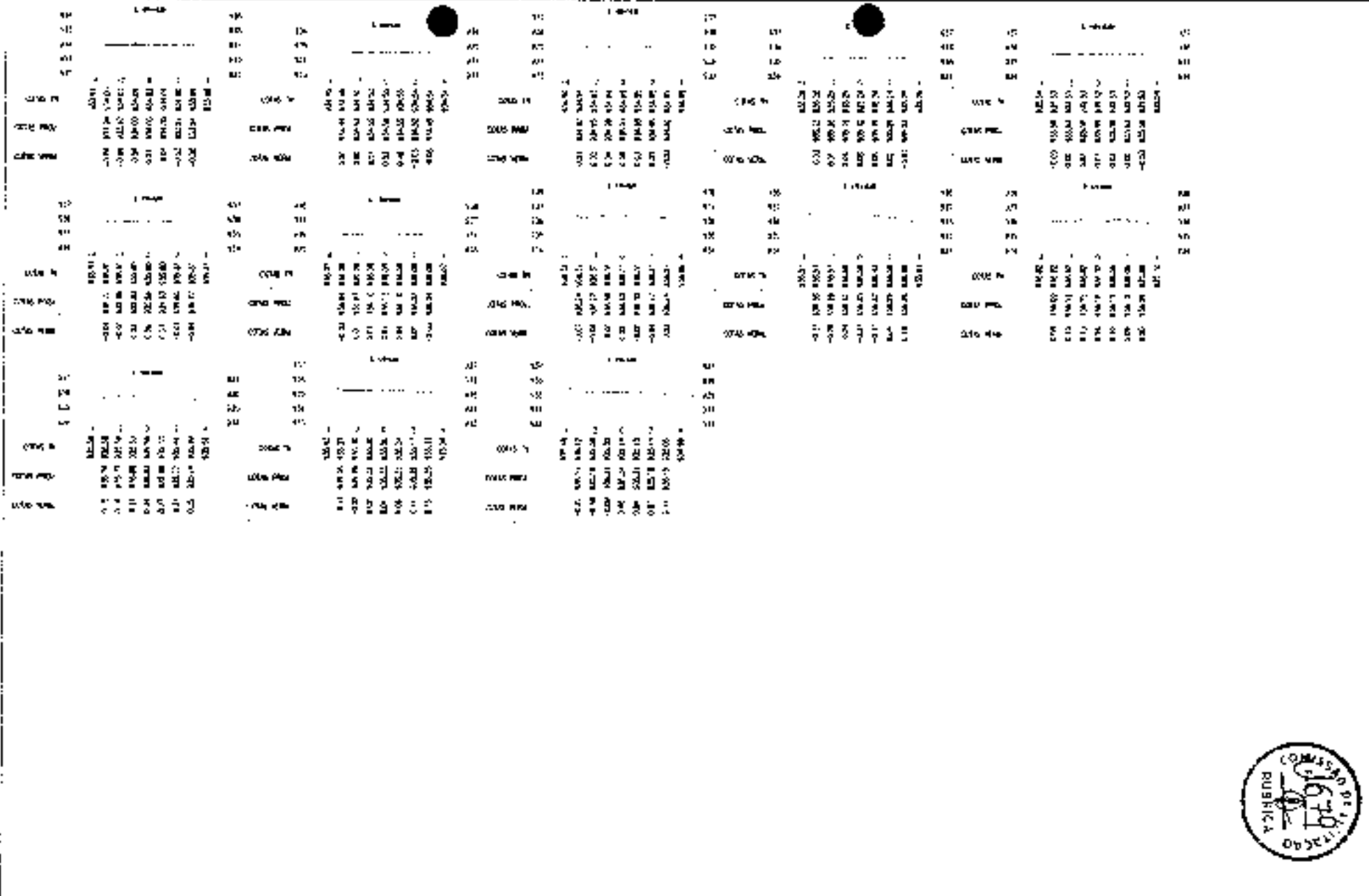

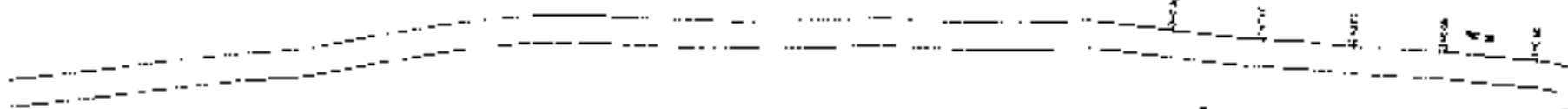

C 1308 2018

	PREFEITURA MUNICIPAL DE GUARACIABA DO NORTE RECONSTRUÇÃO DE ESTRADAS VICINAIS NO MUNICÍPIO DE GUARACIABA DO NORTE - CE - RT 1685/2008 SINALIZAÇÃO VIÁRIA		Nº 1 / 07
	PROJETO DE ARQUIVO	PROJETO DE SINALIZAÇÃO VIÁRIA DE RECONSTRUÇÃO DE ESTRADAS VICINAIS	1 - 300

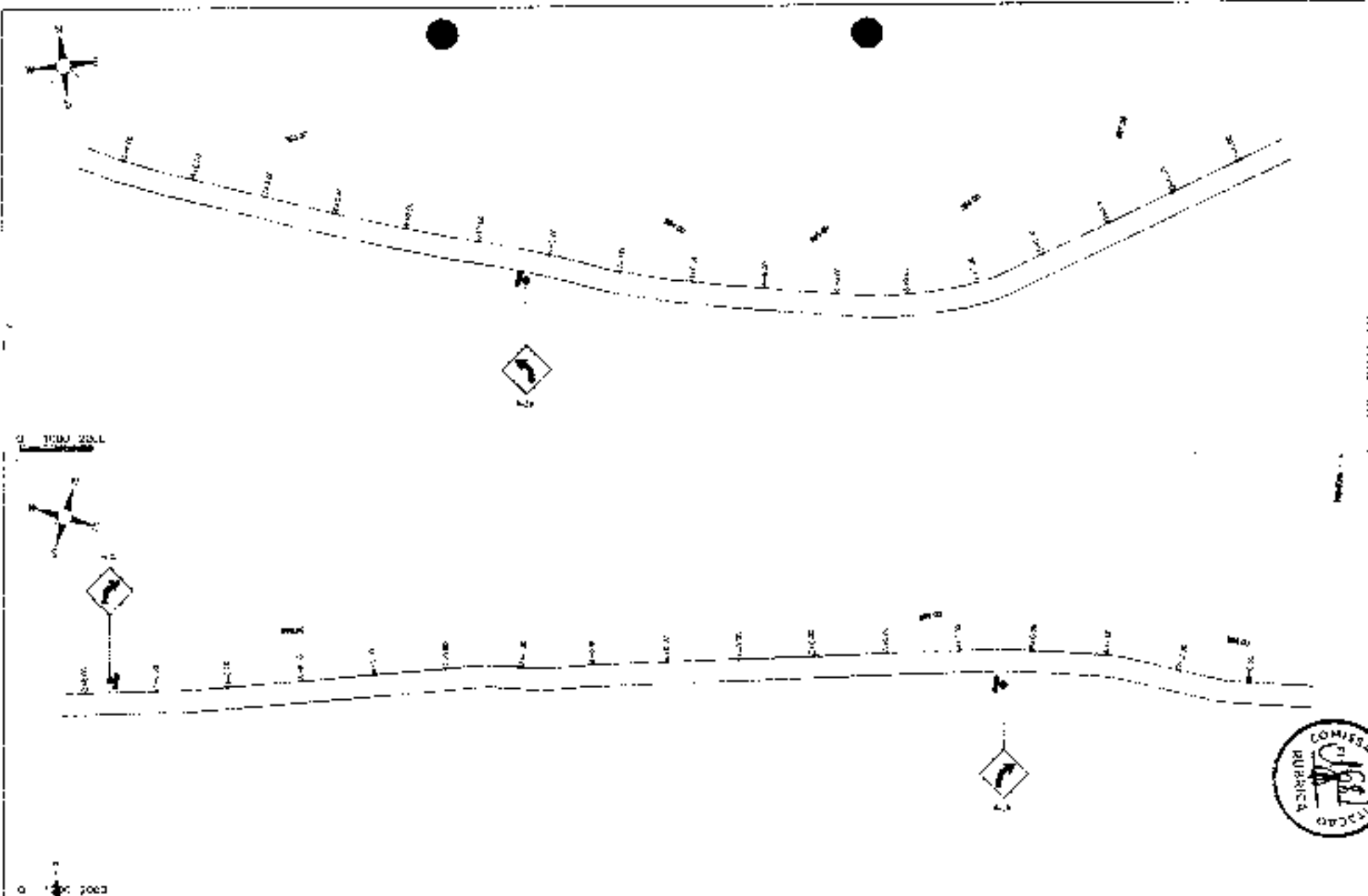

 <p>JOÃO BARROS ENGENHARIA</p>	<p>PREFEITURA MUNICIPAL DE GUARACIABA DO NORTE</p>		<p>2 / 07</p>
	<p>RECUPERAÇÃO DE ESTRADAS VICINAIS NO MUNICÍPIO DE GUARACIABA DO NORTE - DE AT 1068200-03</p>		<p>1:1000</p>
<p>SINALIZAÇÃO VIÁRIA</p>			
<p>PROPOSTA</p>	<p>DESEJO DE VOTOS E VOTANTES</p>	<p>PROPOSTA DE SINALIZAÇÃO</p>	<p>1:1000</p>
<p>PROPOSTA</p>	<p>DESEJO DE VOTOS E VOTANTES</p>	<p>PROPOSTA DE SINALIZAÇÃO</p>	<p>1:1000</p>

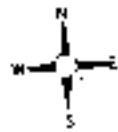

0 1000 2000
Metros Escala

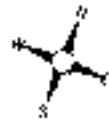

0 1300 2600
Metros Escala

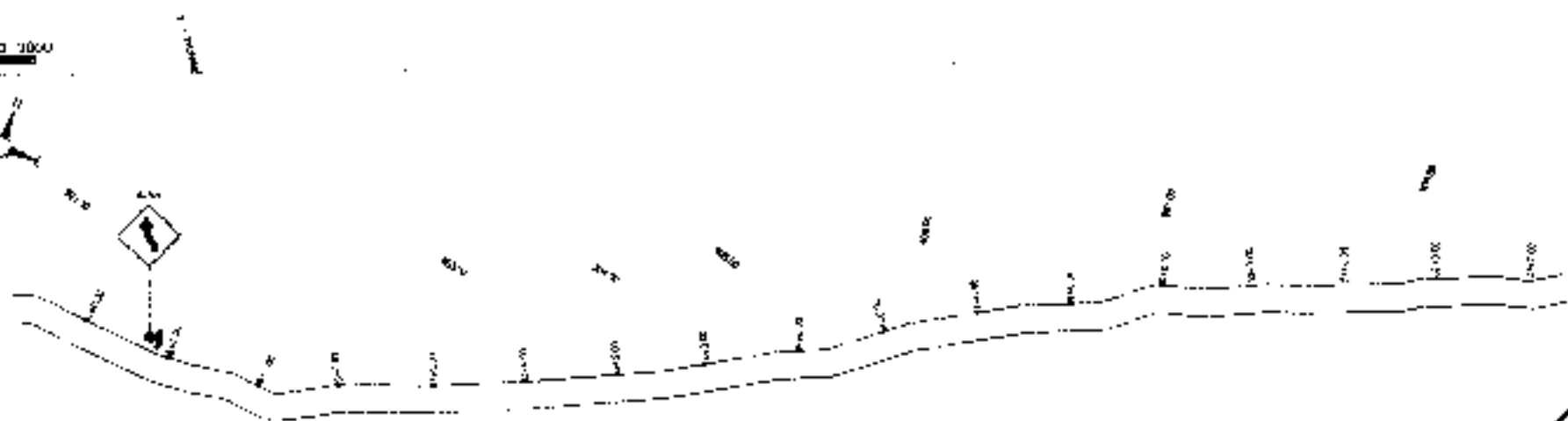
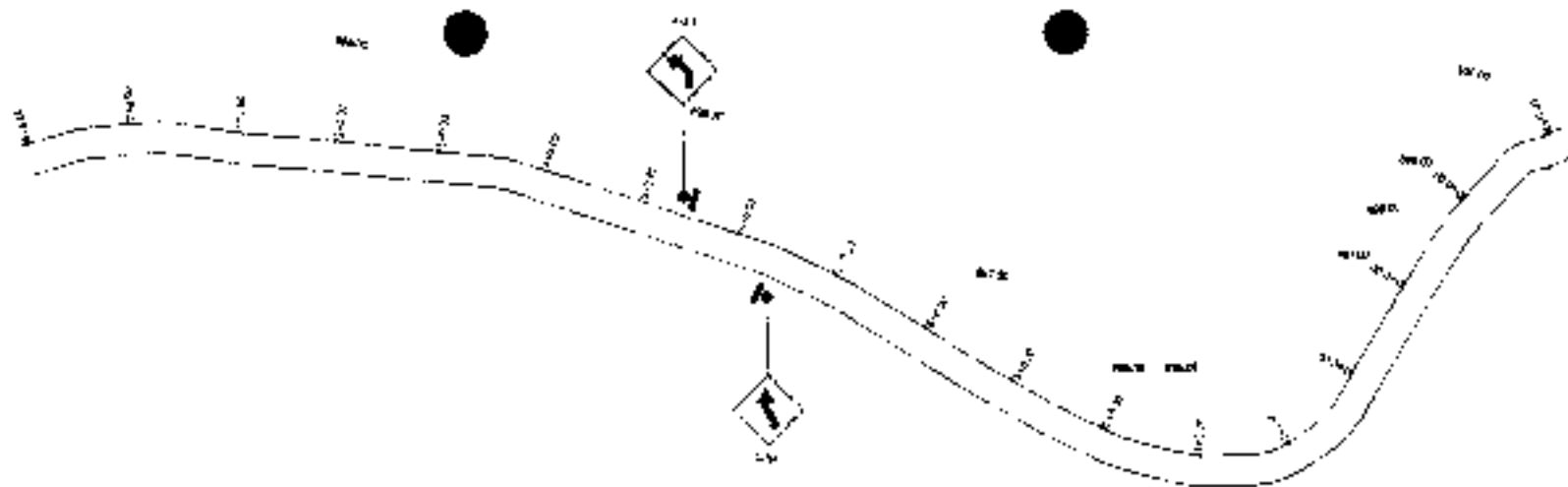

PREFEITURA MUNICIPAL DE GUARACIABA DO NORTE	
REGULAMENTO DE ESTRADAS VICINIAS DO MUNICÍPIO DE GUARACIABA DO NORTE - DE - PT 1356270-03	
SINALIZAÇÃO VIÁRIA	
PROJETO	PROJETO DE SINALIZAÇÃO VIÁRIA
LOCAL	PROJETO DE SINALIZAÇÃO VIÁRIA

3 / 07
17/000

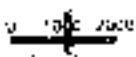

0 100 200

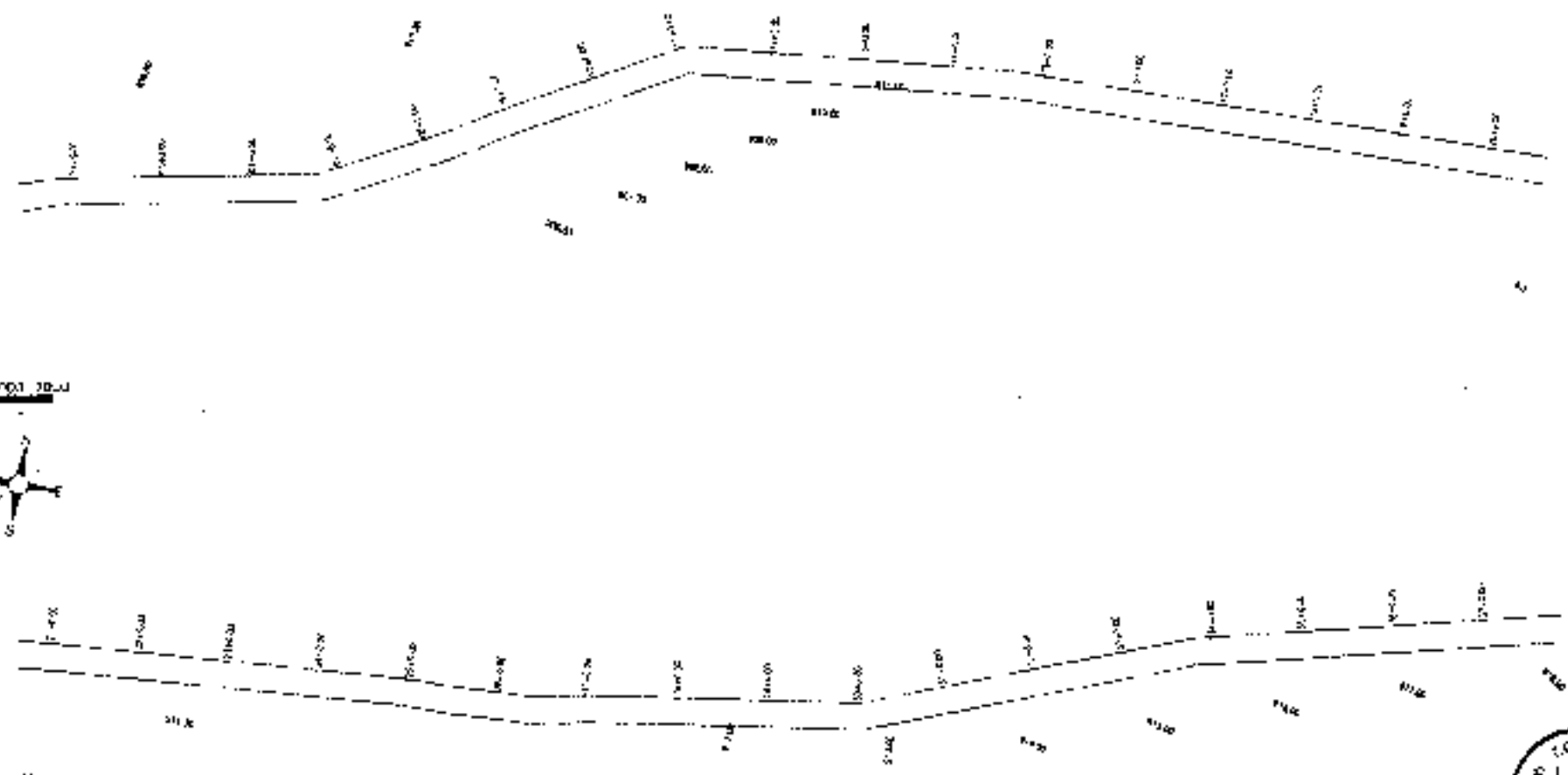

PREFEITURA MUNICIPAL DE GUARACIABA DO NORTE
 RECONSTRUÇÃO DE ESTRADAS VICINAIS NO MUNICÍPIO DE GUARACIABA DO NORTE - CE - Nº 1065270-03
 SINALIZAÇÃO VIÁRIA

4 / 07
 1:1000

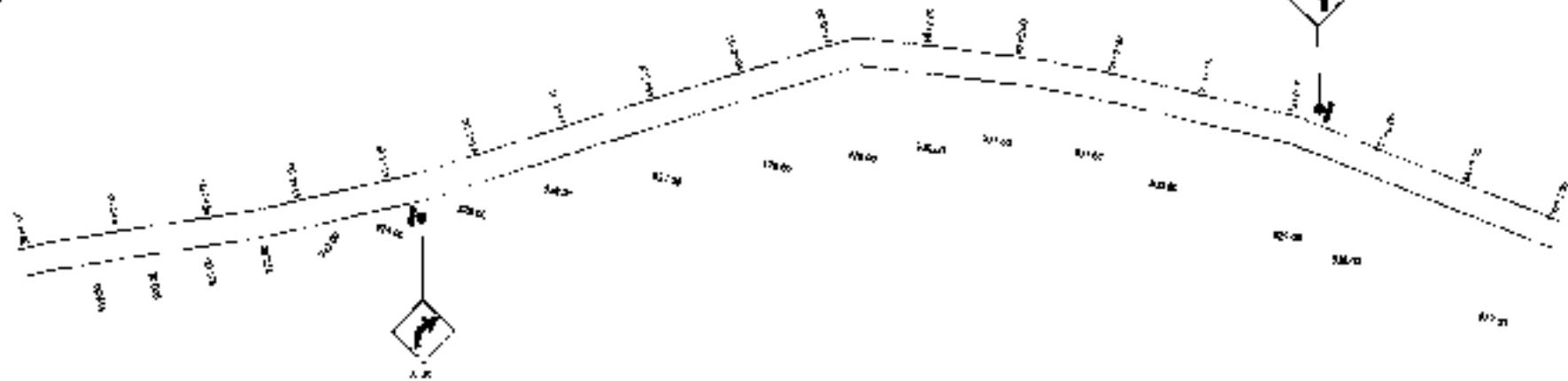

0 1000 2000

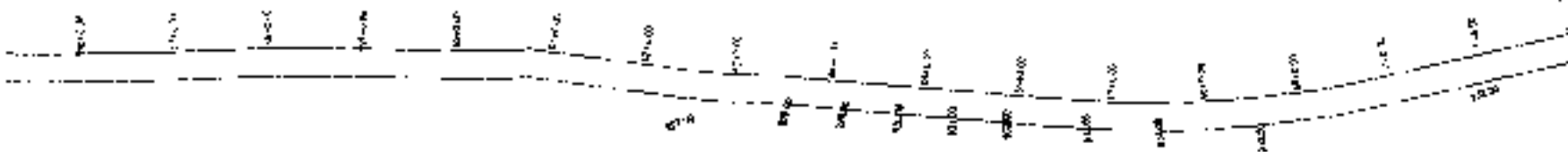

0 1000 2000



	PREFEITURA MUNICIPAL DE GUARACIABA DO NORTE		5 / 07
	RECUPERAÇÃO DE ESTRADAS VICINAIS NO MUNICÍPIO DE GUARACIABA DO NORTE-CE - PT 1006270-03		2014/04
SINALIZAÇÃO VIÁRIA		2014/000	
PROJETO DE SINALIZAÇÃO VIÁRIA			
DE: JOTA PARROS PROJETOS			

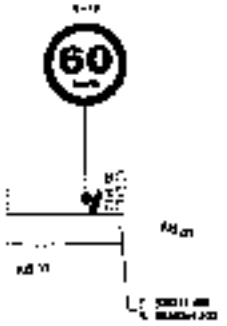

C 1700 2011

40m - 13



	PREFEITURA MUNICIPAL DE GUARAJABA DO NORTE RECUPERAÇÃO DE ESTRADAS VICINAIS NO MUNICÍPIO DE GUARAJABA DO NORTE-CE - PT 1066270-C3 SINALIZAÇÃO VIÁRIA		6 / 07
	PROPOSTA Nº: 001/2011 VALOR: R\$ 1.000,00	DATA DE EMISSÃO: 07/07/2011	11/000

Posicionamento Transversal

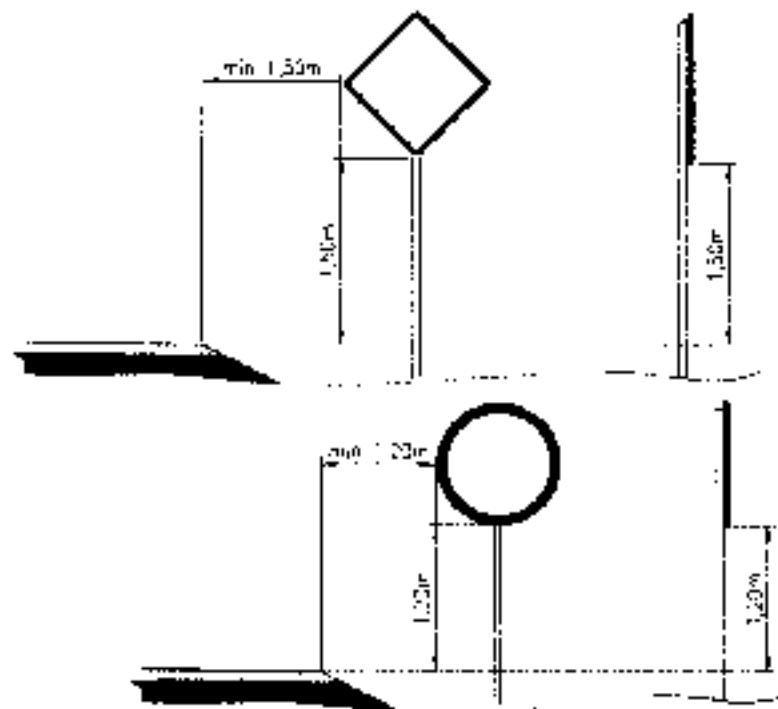

PLACAS DE ADVERTÊNCIA

PLACAS	CODIGO	TAMANHO (cm)	QUANTIDADE (unidade)
	10	40x40	01

PLACAS	CODIGO	TAMANHO (cm)	QUANTIDADE (unidade)
11	10	40x40	01
12	10	40x40	01
13	10	40x40	01
14	10	40x40	01
15	10	40x40	01
16	10	40x40	01
17	10	40x40	01
18	10	40x40	01
19	10	40x40	01
20	10	40x40	01
21	10	40x40	01
22	10	40x40	01
23	10	40x40	01
24	10	40x40	01
25	10	40x40	01
26	10	40x40	01
27	10	40x40	01
28	10	40x40	01
29	10	40x40	01
30	10	40x40	01
31	10	40x40	01
32	10	40x40	01
33	10	40x40	01
34	10	40x40	01
35	10	40x40	01
36	10	40x40	01
37	10	40x40	01
38	10	40x40	01
39	10	40x40	01
40	10	40x40	01
41	10	40x40	01
42	10	40x40	01
43	10	40x40	01
44	10	40x40	01
45	10	40x40	01
46	10	40x40	01
47	10	40x40	01
48	10	40x40	01
49	10	40x40	01
50	10	40x40	01
51	10	40x40	01
52	10	40x40	01
53	10	40x40	01
54	10	40x40	01
55	10	40x40	01
56	10	40x40	01
57	10	40x40	01
58	10	40x40	01
59	10	40x40	01
60	10	40x40	01
61	10	40x40	01
62	10	40x40	01
63	10	40x40	01
64	10	40x40	01
65	10	40x40	01
66	10	40x40	01
67	10	40x40	01
68	10	40x40	01
69	10	40x40	01
70	10	40x40	01
71	10	40x40	01
72	10	40x40	01
73	10	40x40	01
74	10	40x40	01
75	10	40x40	01
76	10	40x40	01
77	10	40x40	01
78	10	40x40	01
79	10	40x40	01
80	10	40x40	01
81	10	40x40	01
82	10	40x40	01
83	10	40x40	01
84	10	40x40	01
85	10	40x40	01
86	10	40x40	01
87	10	40x40	01
88	10	40x40	01
89	10	40x40	01
90	10	40x40	01
91	10	40x40	01
92	10	40x40	01
93	10	40x40	01
94	10	40x40	01
95	10	40x40	01
96	10	40x40	01
97	10	40x40	01
98	10	40x40	01
99	10	40x40	01
100	10	40x40	01

PLACAS DE ADVERTÊNCIA

PLACAS	CODIGO	TAMANHO (cm)	QUANTIDADE (unidade)
	10	40x40	01
	10	40x40	01
	10	40x40	01

As Placas de Advertência sem as seguintes especificações:

Cor	Amarelo	Cor do fundo	Preto
Esp. placa	0,01m	Esp. do poste	0,10m
Esp. do poste	0,30m	Cor do poste	Preto
		Cor do poste	Preto
		Cor do poste	Preto
		Cor do poste	Preto



PREFEITURA MUNICIPAL DE GUARACIABA DO NORTE	
RECLPERAÇÃO DE ESTRADAS VIGIADAS NO MUNICÍPIO DE GUARACIABA DO NORTE-CE - PT 1088275-03	
BINALIZAÇÃO VIÁRIA	
PROPOSTA	107/2024
MUNICÍPIO	GUARACIABA DO NORTE-CE

7 / 07
SEM EBC

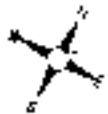

1:000 2:000

Proj. Guaracabas - 10/11 - Loteamento J. Guaracabas

10
5
0
5
10
15
20
25
30
35
40
45
50
55
60
65
70
75
80
85
90
95
100

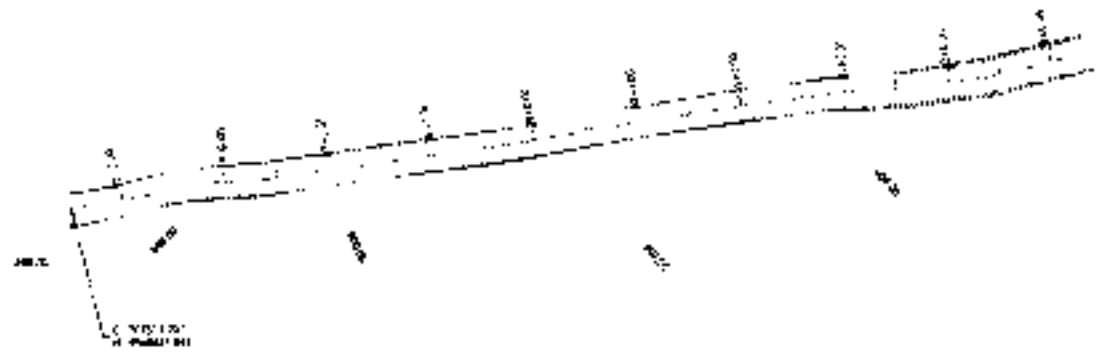

PROJ. GARACABAS - 10/11 - LOTEAMENTO J. GARACABAS

1	2	3	4	5	6	7	8	9	10	11	12	13	14	15	16	17	18	19	20	21	22	23	24	25	26	27	28	29	30	31	32	33	34	35	36	37	38	39	40	41	42	43	44	45	46	47	48	49	50	51	52	53	54	55	56	57	58	59	60	61	62	63	64	65	66	67	68	69	70	71	72	73	74	75	76	77	78	79	80	81	82	83	84	85	86	87	88	89	90	91	92	93	94	95	96	97	98	99	100
---	---	---	---	---	---	---	---	---	----	----	----	----	----	----	----	----	----	----	----	----	----	----	----	----	----	----	----	----	----	----	----	----	----	----	----	----	----	----	----	----	----	----	----	----	----	----	----	----	----	----	----	----	----	----	----	----	----	----	----	----	----	----	----	----	----	----	----	----	----	----	----	----	----	----	----	----	----	----	----	----	----	----	----	----	----	----	----	----	----	----	----	----	----	----	----	----	----	----	-----

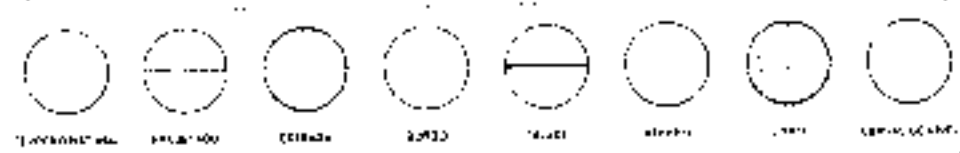

PREFEITURA MUNICIPAL DE GUARACABA DO NORTE
 RECUPERAÇÃO DE ESTRADAS VICIAJAS NO MUNICÍPIO DE GUARACABA DO NORTE - CE - PT 1095270-03
 ESTAQUEAMENTO E PERFIL LONGITUDINAL
 PROJETO: PROJ. GARACABAS - 10/11 - LOTEAMENTO J. GARACABAS
 ANEXO: PLANILHA DE ESTAQUEAMENTO E PERFIL LONGITUDINAL



1 / 08

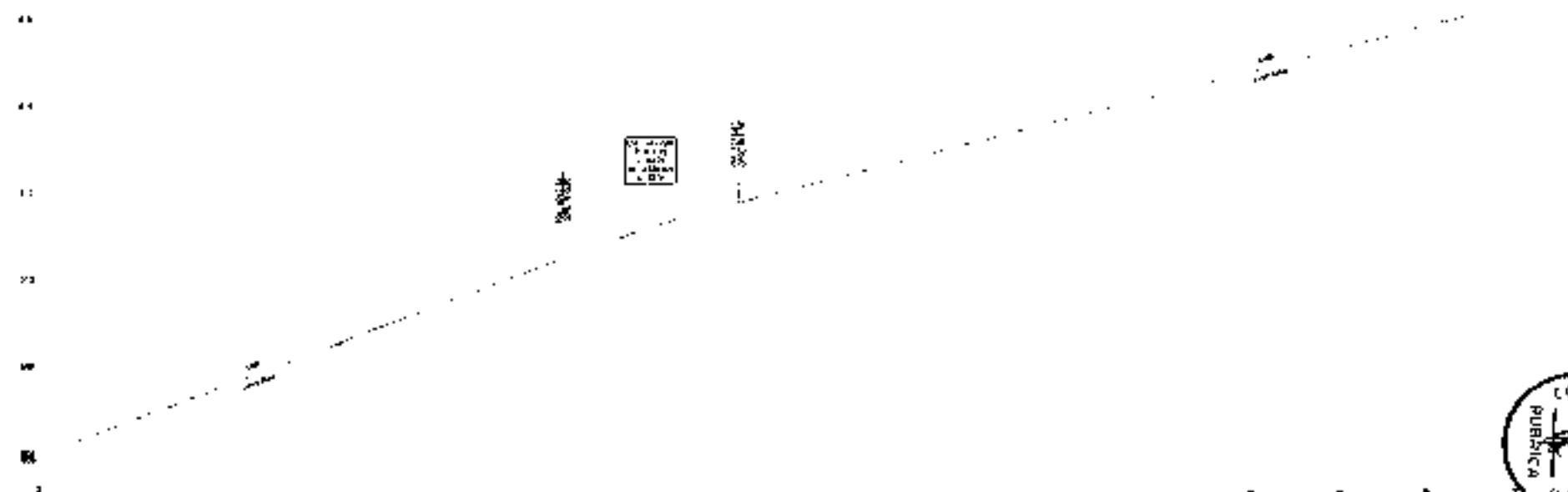

1	2	3	4	5	6	7	8	9	10	11	12	13	14	15	16	17	18	19	20	21	22	23	24	25	26	27	28	29	30	31	32	33	34	35	36	37	38	39	40	41	42	43	44	45	46	47	48	49	50	51	52	53	54	55	56	57	58	59	60	61	62	63	64	65	66	67	68	69	70	71	72	73	74	75	76	77	78	79	80	81	82	83	84	85	86	87	88	89	90	91	92	93	94	95	96	97	98	99	100
---	---	---	---	---	---	---	---	---	----	----	----	----	----	----	----	----	----	----	----	----	----	----	----	----	----	----	----	----	----	----	----	----	----	----	----	----	----	----	----	----	----	----	----	----	----	----	----	----	----	----	----	----	----	----	----	----	----	----	----	----	----	----	----	----	----	----	----	----	----	----	----	----	----	----	----	----	----	----	----	----	----	----	----	----	----	----	----	----	----	----	----	----	----	----	----	----	----	----	-----

VERGAMENTO	PROVA DE	ENTRADA	SAÍDA	VAZÃO	ALCANTARALA	VAZÃO	PROVA DE



PREFEITURA MUNICIPAL DE GUARACIABA DO NORTE
 RECUPERAÇÃO DE ESTRADAS VICINAIS AO MUNICÍPIO DE GUARACIABA DO NORTE-CE - PI 1086210/03
ESTACQUEAMENTO E PERFIL LONGITUDINAL
 PROPOSTA: 02/2015
 PROJETO: 02/2015

2 / 02
 15/02/2015
 15/02/2015



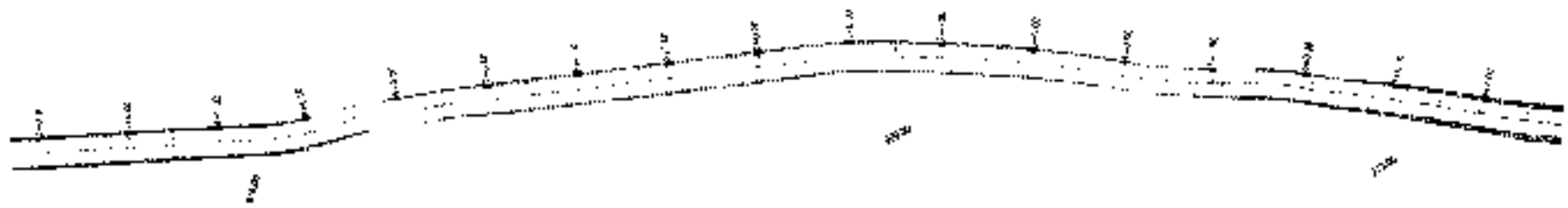

0 1000 2000

Projeto de Estrada - 10/08/2007

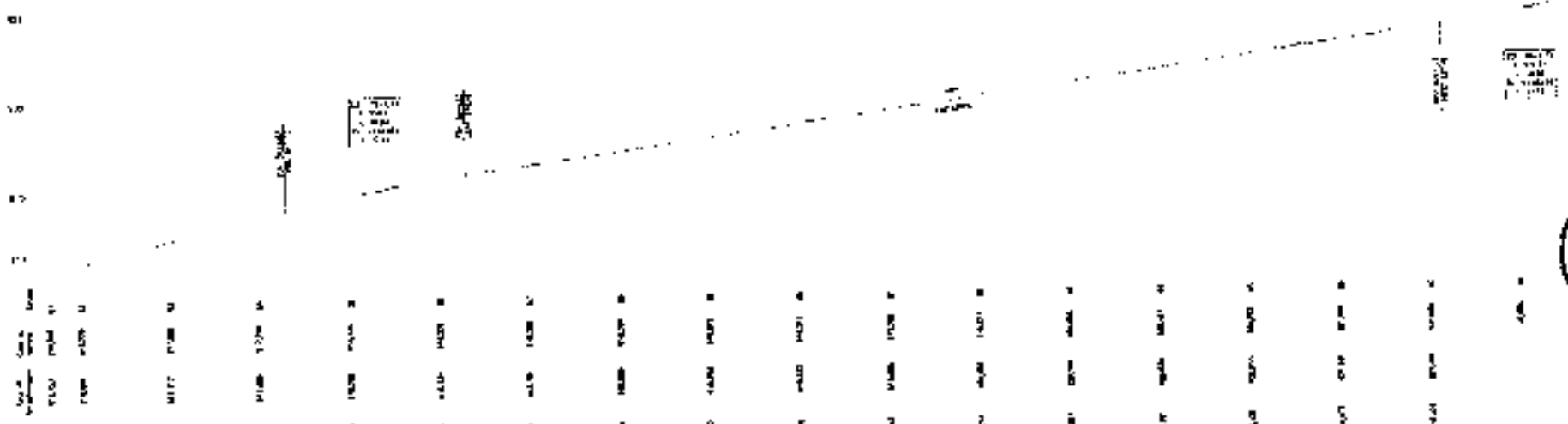

Est. (m)	Alt. (m)	Alt. (m)	Alt. (m)	Alt. (m)	Alt. (m)	Alt. (m)	Alt. (m)	Alt. (m)	Alt. (m)	Alt. (m)	Alt. (m)	Alt. (m)	Alt. (m)	Alt. (m)	Alt. (m)	Alt. (m)	Alt. (m)
0+00	1.00	1.00	1.00	1.00	1.00	1.00	1.00	1.00	1.00	1.00	1.00	1.00	1.00	1.00	1.00	1.00	1.00
0+25	1.00	1.00	1.00	1.00	1.00	1.00	1.00	1.00	1.00	1.00	1.00	1.00	1.00	1.00	1.00	1.00	1.00
0+50	1.00	1.00	1.00	1.00	1.00	1.00	1.00	1.00	1.00	1.00	1.00	1.00	1.00	1.00	1.00	1.00	1.00
0+75	1.00	1.00	1.00	1.00	1.00	1.00	1.00	1.00	1.00	1.00	1.00	1.00	1.00	1.00	1.00	1.00	1.00
1+00	1.00	1.00	1.00	1.00	1.00	1.00	1.00	1.00	1.00	1.00	1.00	1.00	1.00	1.00	1.00	1.00	1.00



PREFEITURA MUNICIPAL DE GUARACIABA DO NORTE
 RECUPERAÇÃO DE ESTRADAS VICINAIS NO MUNICÍPIO DE GUARACIABA DO NORTE-RN - PT 1084270-03
 ESTAQUEAMENTO E PERFIL LONGITUDINAL
 PROJETO DE: JOTA BARROS ENGENHARIA E ARQUITETURA
 RUA FÁBIO BARRETO, 100 - JARDIM SÃO CARLOS - GUARACIABA DO NORTE - RN

Nº: 3 / DB
 DATA: 10/08/2007
 LOCAL:

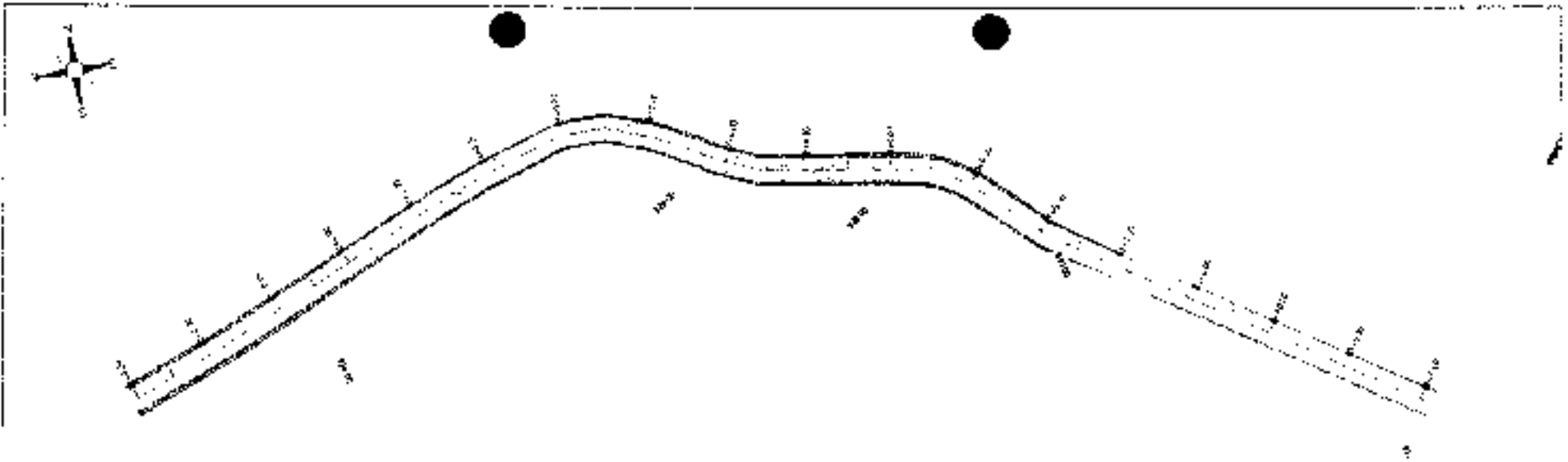

0
10
20
30
40
50
60
70
80
90
100

0+00	0+10	0+20	0+30	0+40	0+50	0+60	0+70	0+80	0+90	1+00	1+10	1+20	1+30	1+40	1+50	1+60	1+70	1+80	1+90	2+00
0+00	0+10	0+20	0+30	0+40	0+50	0+60	0+70	0+80	0+90	1+00	1+10	1+20	1+30	1+40	1+50	1+60	1+70	1+80	1+90	2+00
0+00	0+10	0+20	0+30	0+40	0+50	0+60	0+70	0+80	0+90	1+00	1+10	1+20	1+30	1+40	1+50	1+60	1+70	1+80	1+90	2+00
0+00	0+10	0+20	0+30	0+40	0+50	0+60	0+70	0+80	0+90	1+00	1+10	1+20	1+30	1+40	1+50	1+60	1+70	1+80	1+90	2+00



PREFEITURA MUNICIPAL DE GUARACIABA DO NORTE
 RECUPERAÇÃO DE ESTRADAS VICINAIS NO MUNICÍPIO DE GUARACIABA DO NORTE-CE - PT 1006270-03
 ESTADUEAMENTO E PERFIL LONGITUDINAL

PROJETA	PROF. DR. JOÃO CARLOS FERREIRA DE ALMEIDA
PROVA	REVISÃO: 01





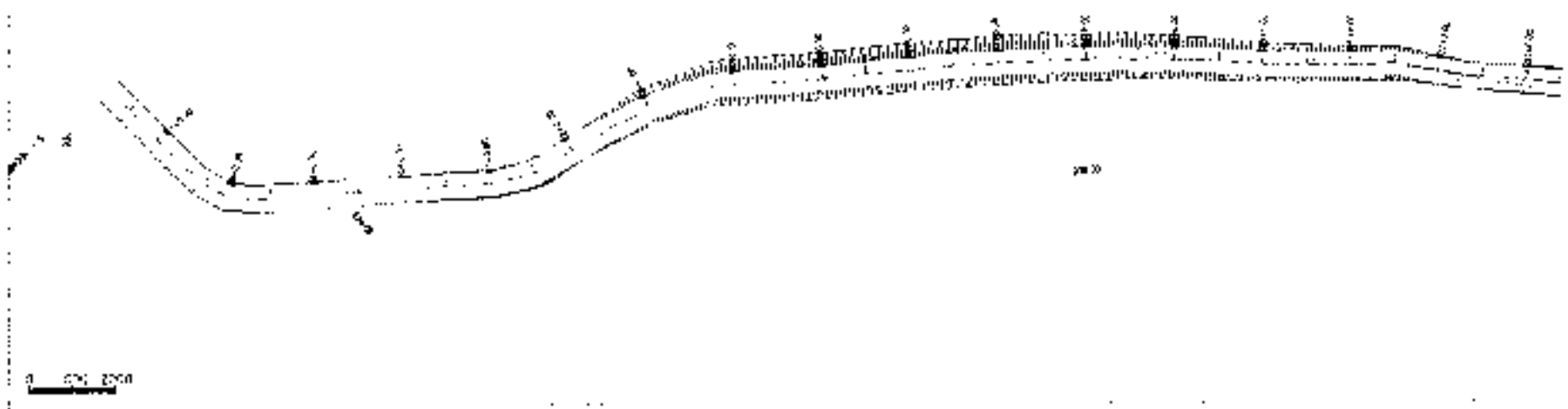



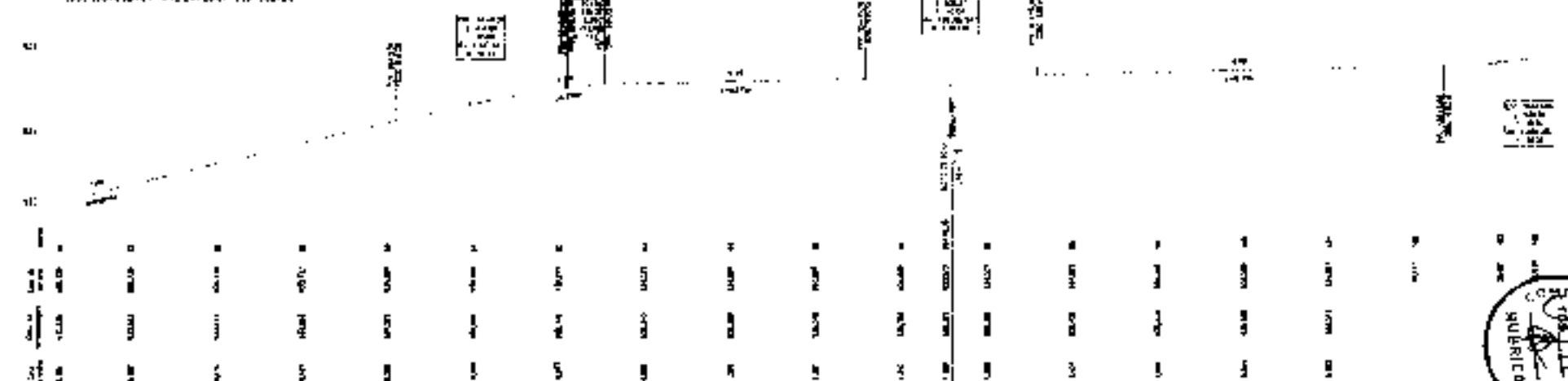

4 / 08
 H 11:00
 11/11/2023



1:1000

See Elevation - See Legend for Colors



- 
DRENAGEM
- 
BOCA DE LAMPARA
- 
PAVIMENTO
- 
LARGURA
- 
PENTE
- 
ESTRUTURA
- 
UTILIDADE PUBLICA
- 
BARRERA



PREFEITURA MUNICIPAL DE GUARACIABA DO NORTE		5 / 08
RECUPERAÇÃO DE ESTRADAS VICINAIS NO MUNICÍPIO DE GUARACIABA DO NORTE - GE - P 10822040		
ESTAQUEAMENTO E PERFIL LONGITUDINAL		
PROJETO:	DR. SÉRGIO AUGUSTO DE MOURA	DATA: 11/02/2011
AUTOR:	DR. SÉRGIO AUGUSTO DE MOURA	V. 01/11



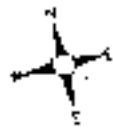

Mapa: 17



346 Situação Geral do Terreno dos Muros

1:1000 00/00

11
12
13
14
15
16
17
18
19
20
21
22
23
24
25
26
27
28
29
30
31
32
33
34
35
36
37
38
39
40
41
42
43
44
45
46
47
48
49
50
51
52
53
54
55
56
57
58
59
60
61
62
63
64
65
66
67
68
69
70
71
72
73
74
75
76
77
78
79
80
81
82
83
84
85
86
87
88
89
90
91
92
93
94
95
96
97
98
99
100

100	101	102	103	104	105	106	107	108	109	110	111	112	113	114	115	116	117	118	119	120
121	122	123	124	125	126	127	128	129	130	131	132	133	134	135	136	137	138	139	140	141
142	143	144	145	146	147	148	149	150	151	152	153	154	155	156	157	158	159	160	161	162
163	164	165	166	167	168	169	170	171	172	173	174	175	176	177	178	179	180	181	182	183
184	185	186	187	188	189	190	191	192	193	194	195	196	197	198	199	200	201	202	203	204
205	206	207	208	209	210	211	212	213	214	215	216	217	218	219	220	221	222	223	224	225
226	227	228	229	230	231	232	233	234	235	236	237	238	239	240	241	242	243	244	245	246
247	248	249	250	251	252	253	254	255	256	257	258	259	260	261	262	263	264	265	266	267
268	269	270	271	272	273	274	275	276	277	278	279	280	281	282	283	284	285	286	287	288
289	290	291	292	293	294	295	296	297	298	299	300	301	302	303	304	305	306	307	308	309
310	311	312	313	314	315	316	317	318	319	320	321	322	323	324	325	326	327	328	329	330

PROVAÇÃO	PROVAÇÃO	ESTRADA	MURO	TRILHA	MURO	TRILHA	PROVAÇÃO



PREFEITURA MUNICIPAL DE ILARACIABA DO NORTE

RECUPERAÇÃO DE ESTRADAS VICINAIS NO MUNICÍPIO DE ILARACIABA DO NORTE - PE - PI 1086270-03

ESTAQUEAMENTO E PERFIL LONGITUDINAL

PROPOSTA	PROVAÇÃO
MUNICÍPIO	ILARACIABA DO NORTE - PE - PI 1086270-03

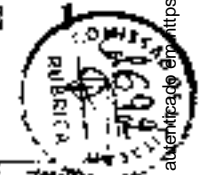

6 / 08

Ilaraciaba do Norte - PE

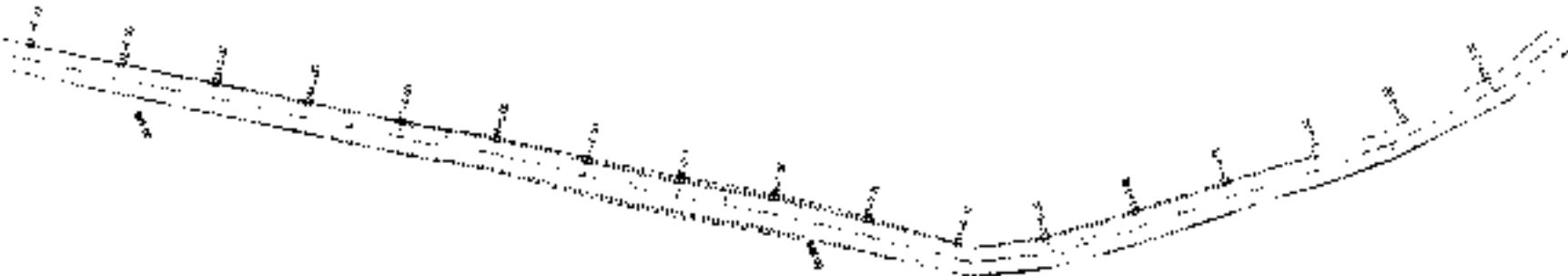

1:500 20:0

Distância em metros

10
20
30
40

0+00	0+10	0+20	0+30	0+40	0+50	0+60	0+70	0+80	0+90	1+00	1+10	1+20	1+30	1+40	1+50	1+60	1+70	1+80	1+90	2+00
0	0	0	0	0	0	0	0	0	0	0	0	0	0	0	0	0	0	0	0	0
0	0	0	0	0	0	0	0	0	0	0	0	0	0	0	0	0	0	0	0	0
0	0	0	0	0	0	0	0	0	0	0	0	0	0	0	0	0	0	0	0	0

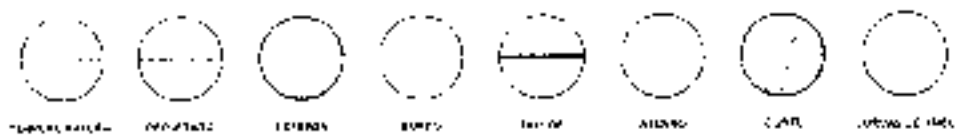

PREFEITURA MUNICIPAL DE GLARCIABA DO NORTE
 REQUALIFICAÇÃO DE ESTRADAS VICINAIS NO MUNICÍPIO DE GUARACIABA DO NORTE CE - PT 1086270-03
 ESTADQUEAMENTO E PERFIL LONGITUDINAL



7/08
 VALOR
 R\$ 100,00



1:1000 2003

100m



São Sebastião - São Sebastião da Gramma

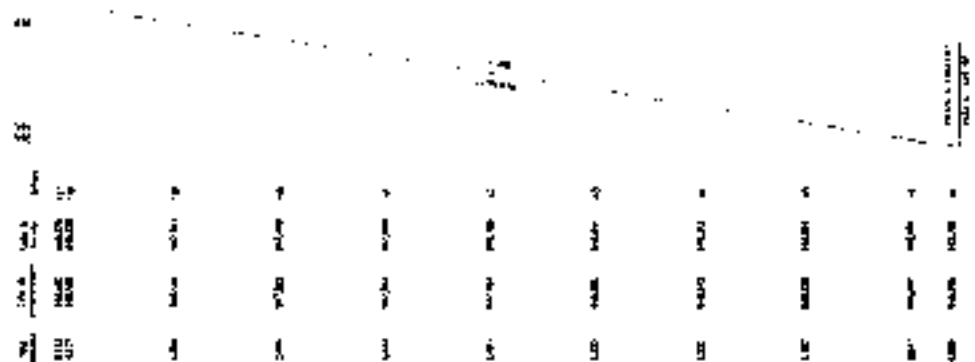



PREFEITURA MUNICIPAL DE GUARACIABA DO NORTE
 RECUPERAÇÃO DE ESTRADAS VICINAIS NO MUNICÍPIO DE GUARACIABA DO NORTE-CE - PT 10852/0/03
ESTAQUEAMENTO E PERFIL LONGITUDINAL

PROJETO: RECUPERAÇÃO DE ESTRADAS VICINAIS NO MUNICÍPIO DE GUARACIABA DO NORTE-CE - PT 10852/0/03
 LOCAL: RUA S. JOSÉ - BARRIO S. JOSE - GUARACIABA DO NORTE - CE

escala: 1:1000
 data: 08/02/2003
 hora: 14:30h
 local: 03

LEGENDA

-  ATERRO
-  CORTE

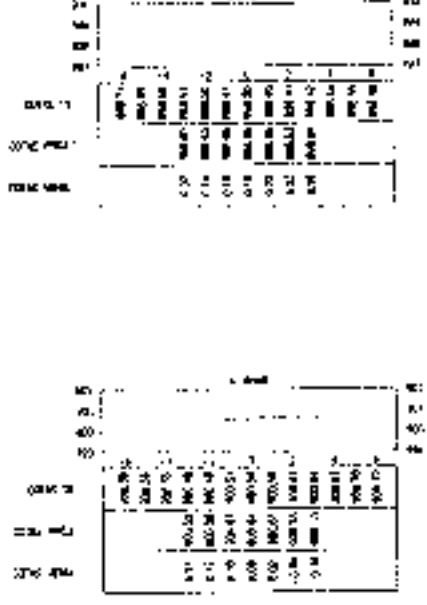
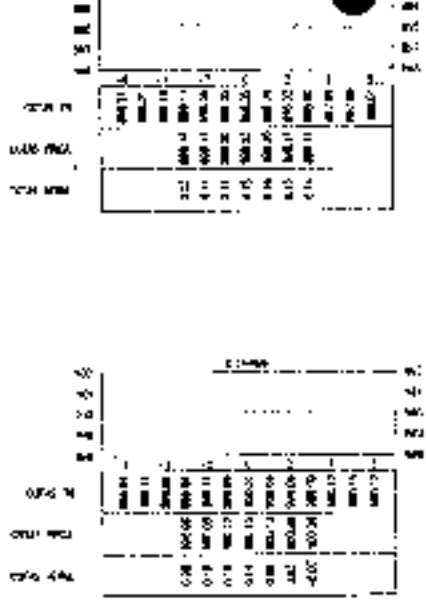
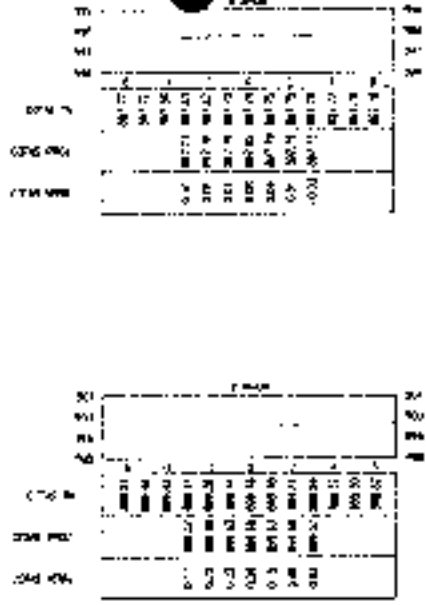
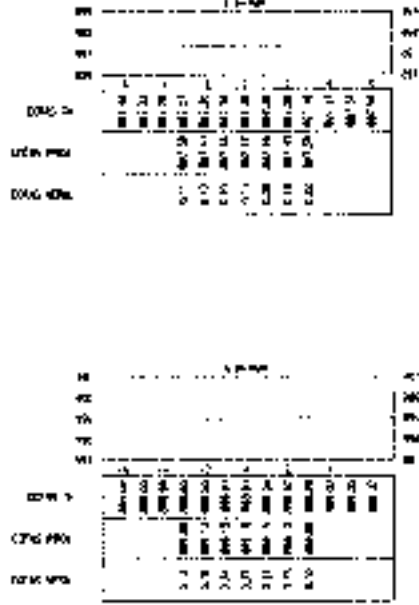
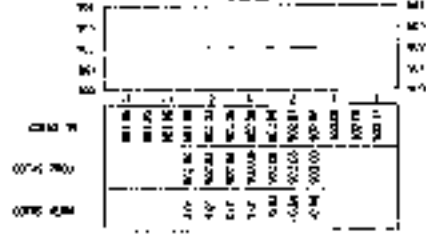
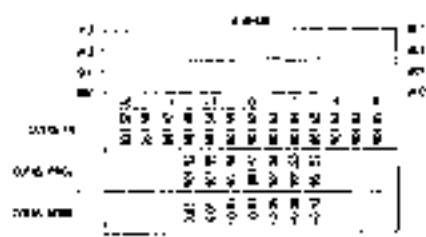



PREFEITURA MUNICIPAL DE GLARACIARA DO NORTE
 RECUPERAÇÃO DE ESTRADAS VICINAIS NO MUNICÍPIO DE GLARACIARA DO NORTE-DE-PA
 SEÇÕES TRANSVERSAIS

PLANTAS: RUA DA SENHORA MARIA DO CARMO - 1008274MS
 FOLHA: 01 - 1008274MS - 1008274MS - 1008274MS



LEGENDA

-  ATERRO
-  LIMITE

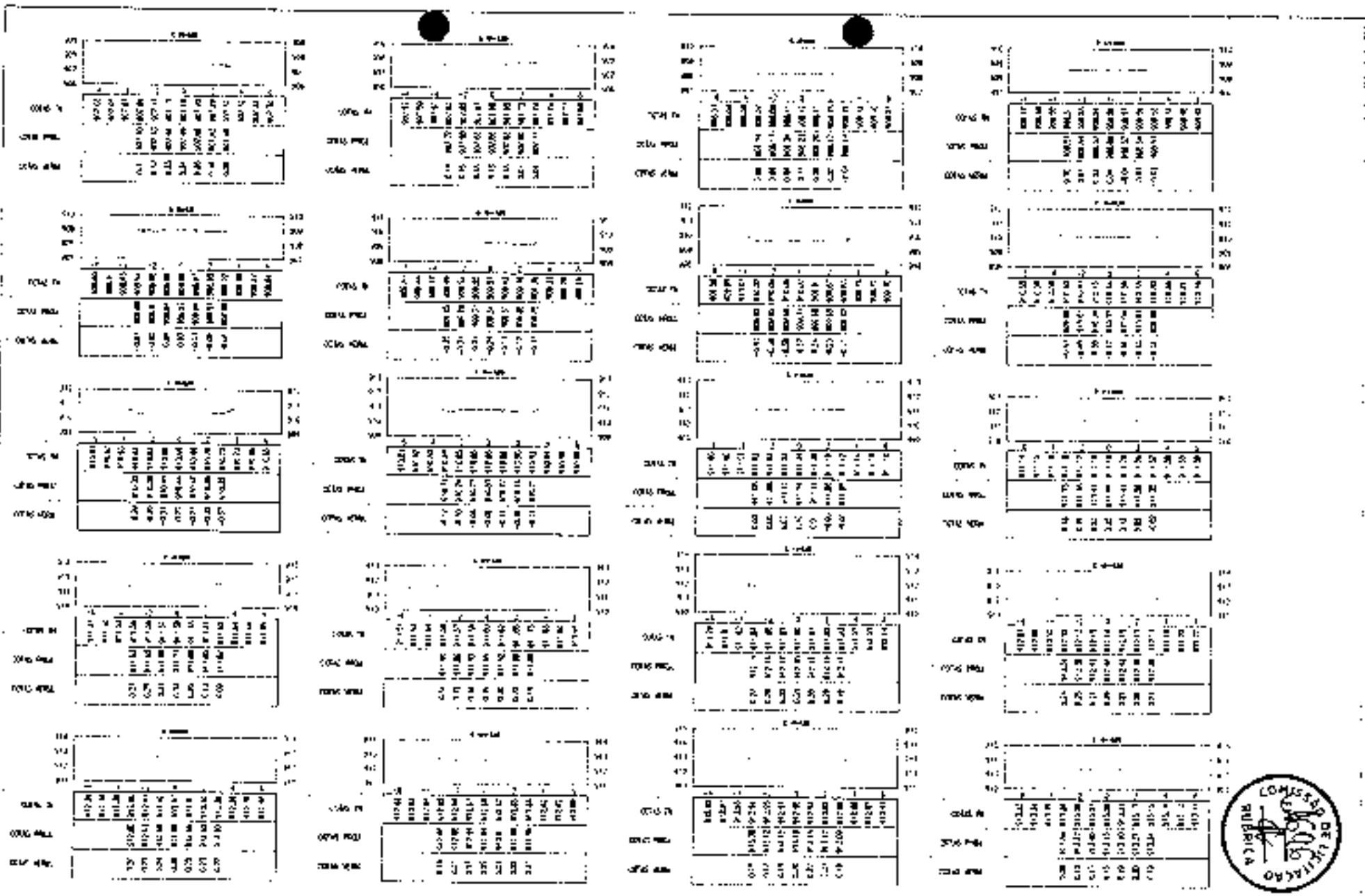

PREFEITURA MUNICIPAL DE GUARACABA DO NORTE
 RECUPERAÇÃO DE ESTRADAS VICINAIS NO MUNICÍPIO DE GUARACIARA
 DO NORTE-CE - PT 1086210-03
 SEÇÕES TRANSVERSAIS

PROJETO: RUA DA LIBERDADE, LOTEAMENTO DO ATERRO DE
 GUARACIARA DO NORTE - CE - 1086210-03
 DATA: 05/08/2010

2 / 13
 1/250



LEGENDA

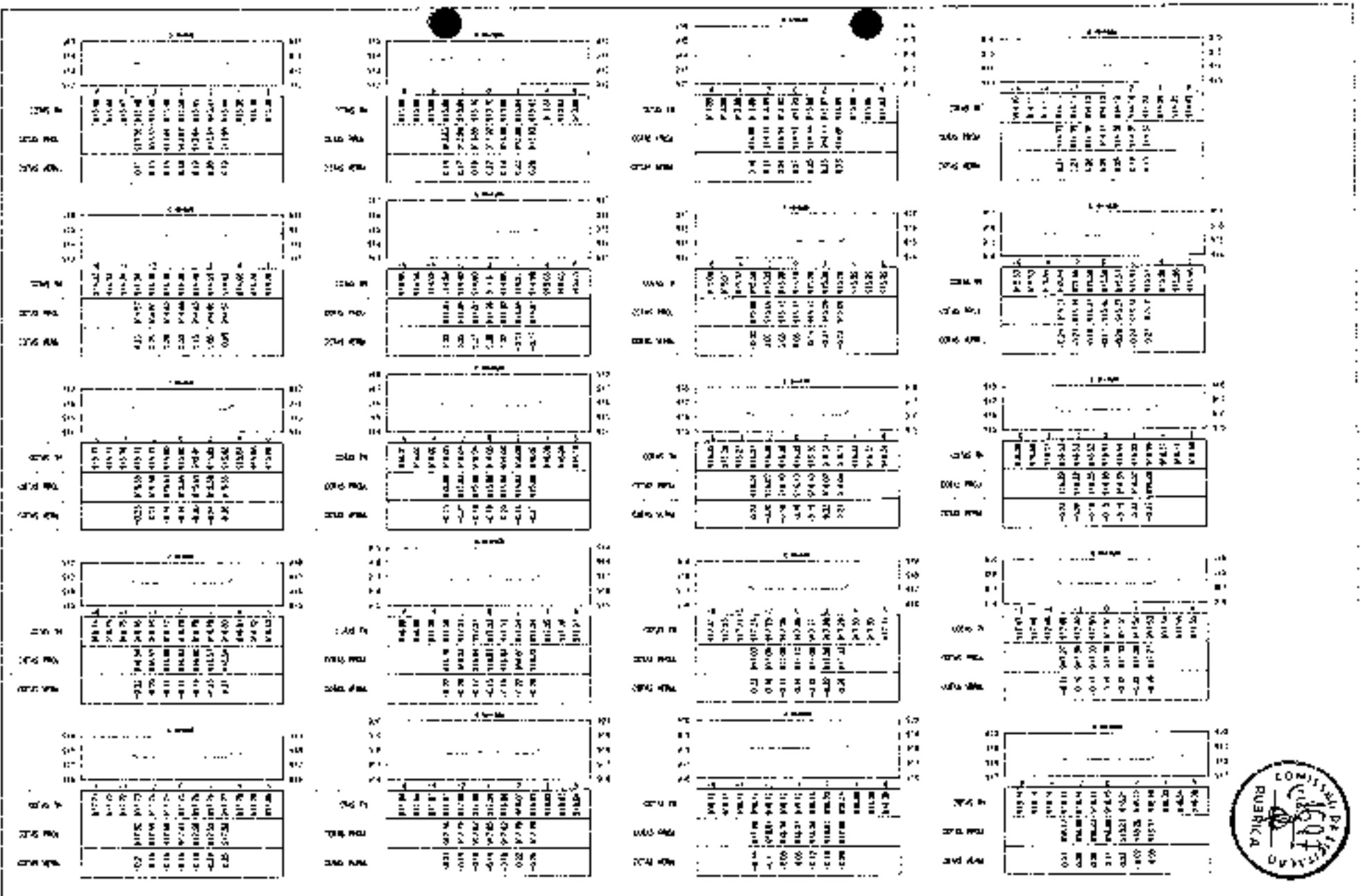
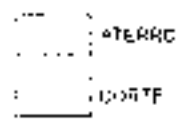

PREFEITURA MUNICIPAL DE GUARACIABA DO NORTE		3 / 13
RECUPERAÇÃO DE ESTRADAS VICINAIS NO MUNICÍPIO DE GUARACIABA DO NORTE-CE - P.º 1086270-00		10256
SEÇÕES TRANSVERSAIS		
PROJETISTA	DR. CARLOS ALBERTO VASCONCELOS DE MENEZES	
PROJETO	PROJETO DE RECUPERAÇÃO DE ESTRADAS VICINAIS	



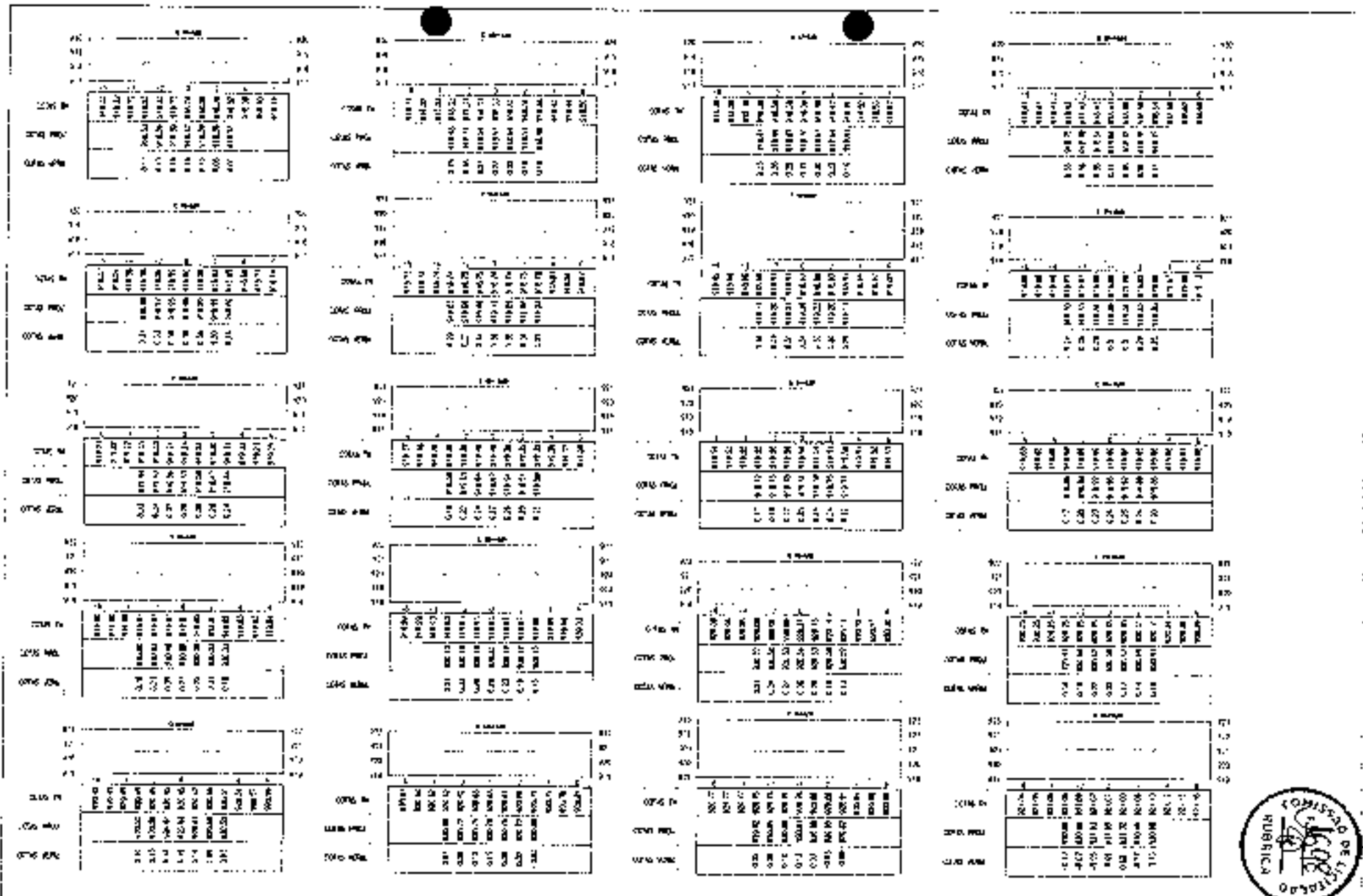

LEGENDA



PREFEITURA MUNICIPAL DE OLARIA (CABA) NORTE
 RECUPERAÇÃO DE ESTRADAS VICINAIS NO MUNICÍPIO DE GUARACIMBA
 DO NORTE - CE - R# 1085270-03
 SEÇÕES TRANSVERSAIS



LEGENDA

-  ATERRO
-  CORTE

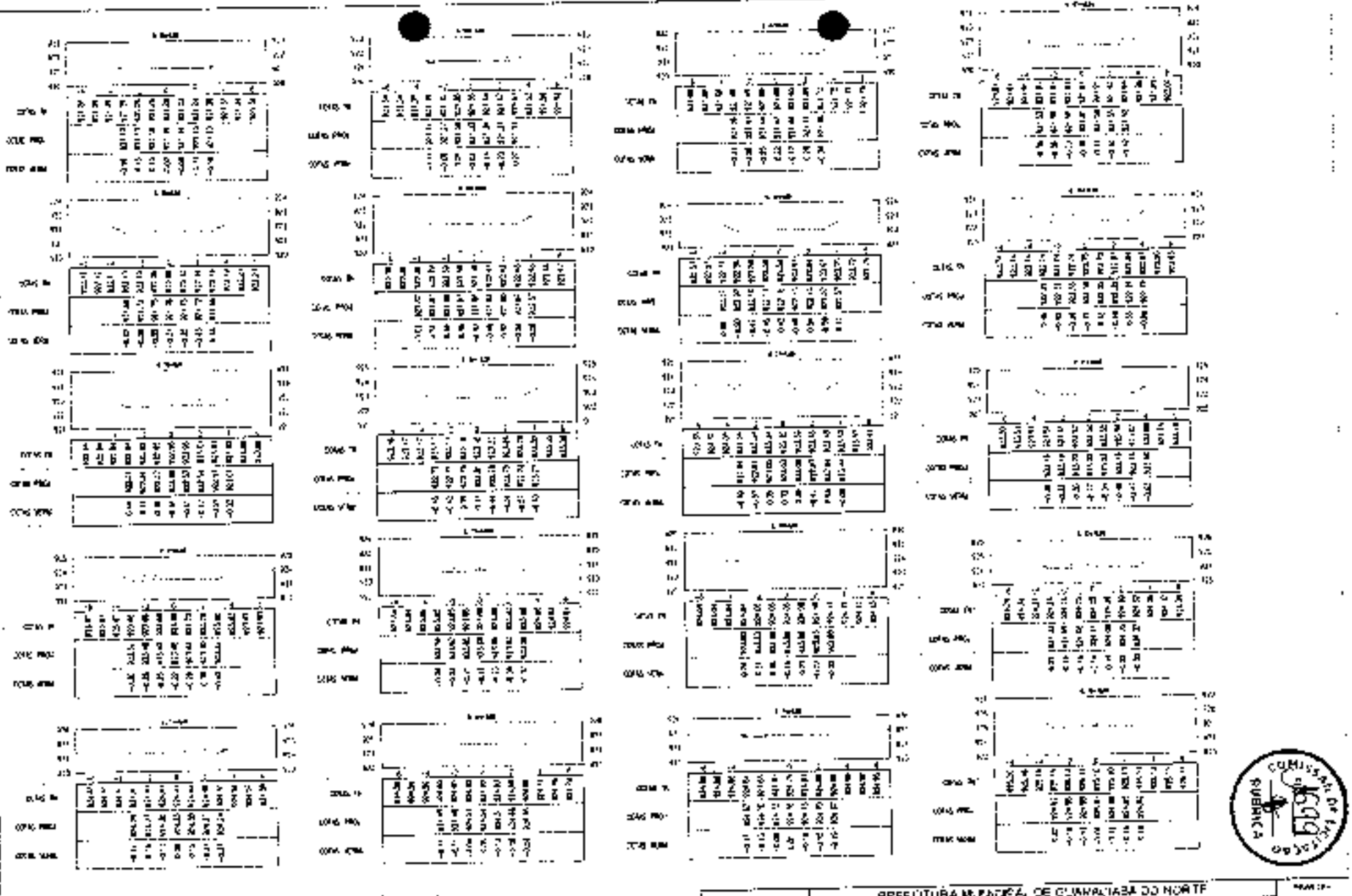

PREFEITURA MUNICIPAL DE GUARACIABA DO NORTE
 RECUPERAÇÃO DE ESTRADAS VICINAIS NO MUNICÍPIO DE GUARACIABA DO NORTE-CE - PT 1386270-23
 BEGÕES TRANSVERSAIS

NUM. DE
 5 / 13
 ANEXO
 1266



LEGENDA

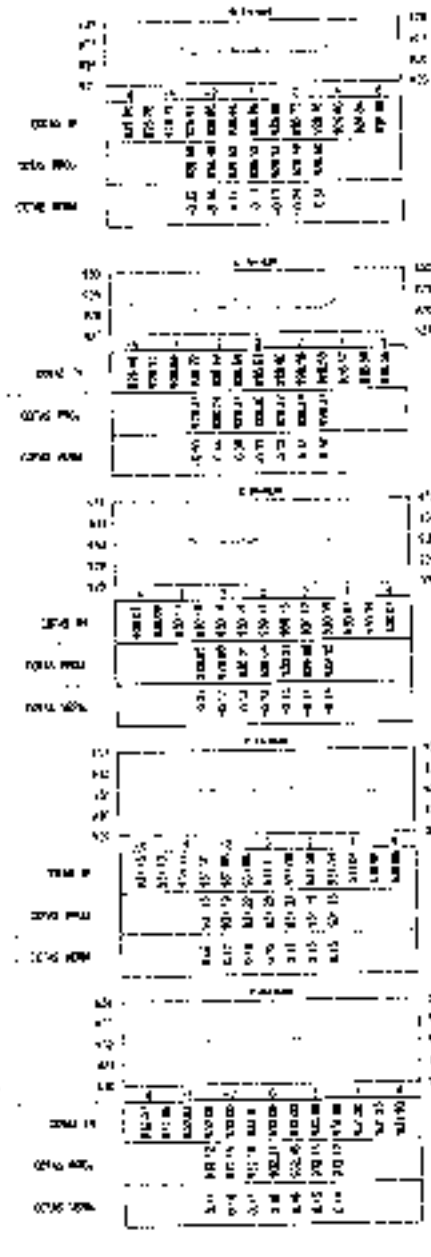
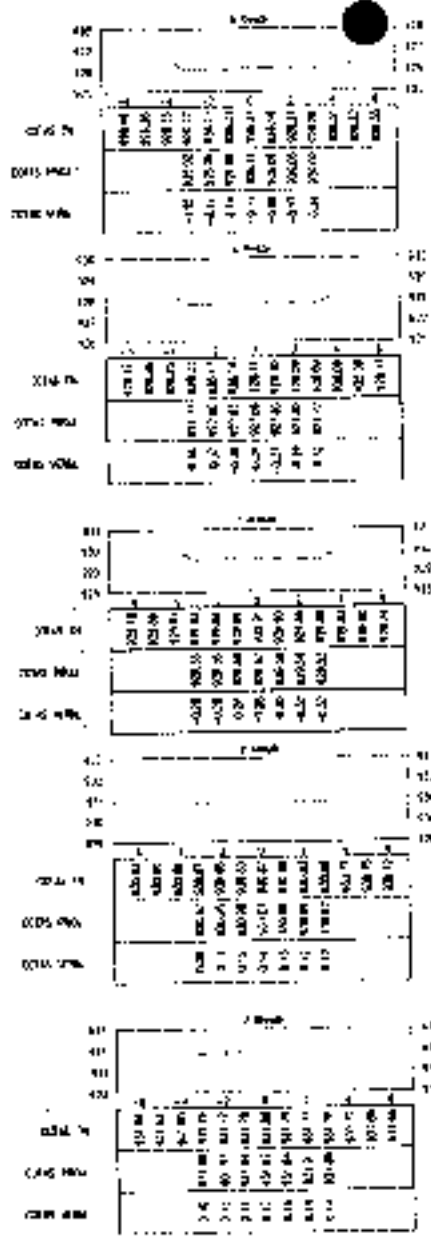
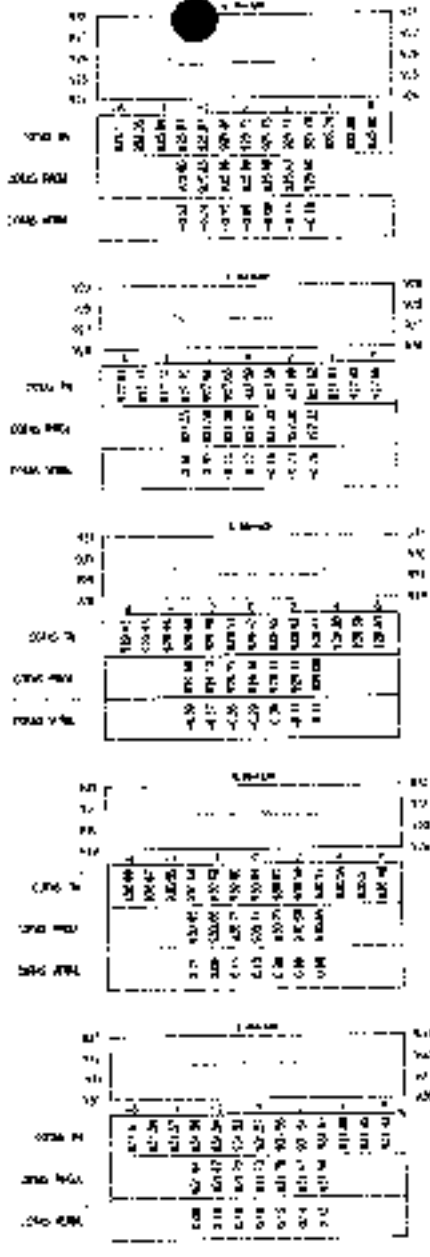
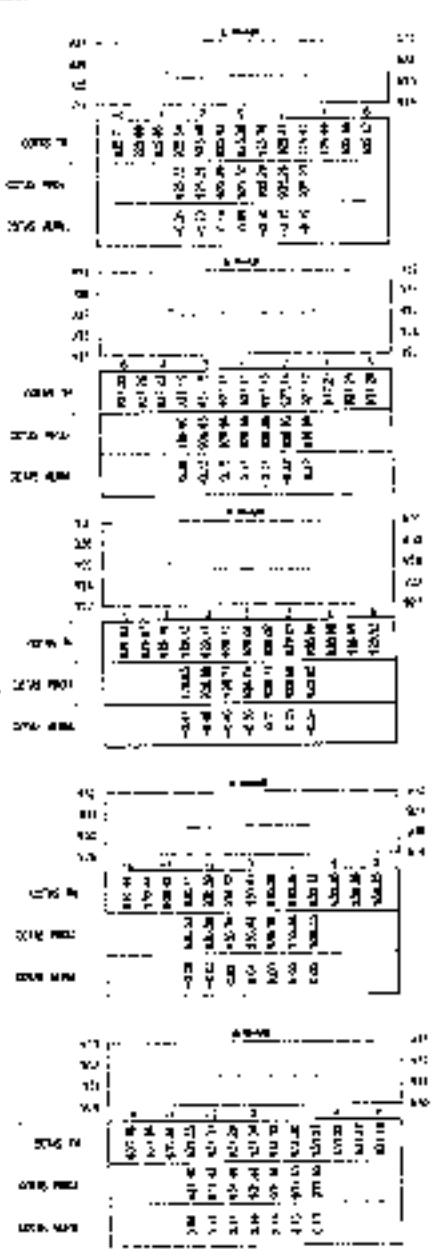
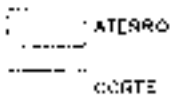



PREFEITURA MUNICIPAL DE QUARACIABA DO NORTE
 RECUPERAÇÃO DE ESTRADAS VICINAIS NO MUNICÍPIO DE QUARACIABA DO NORTE-CE - P. 1088270-03
 SEÇÕES TRANSVERSAIS

6 / 13



LEGENDA

 ATERRO
 COGTE

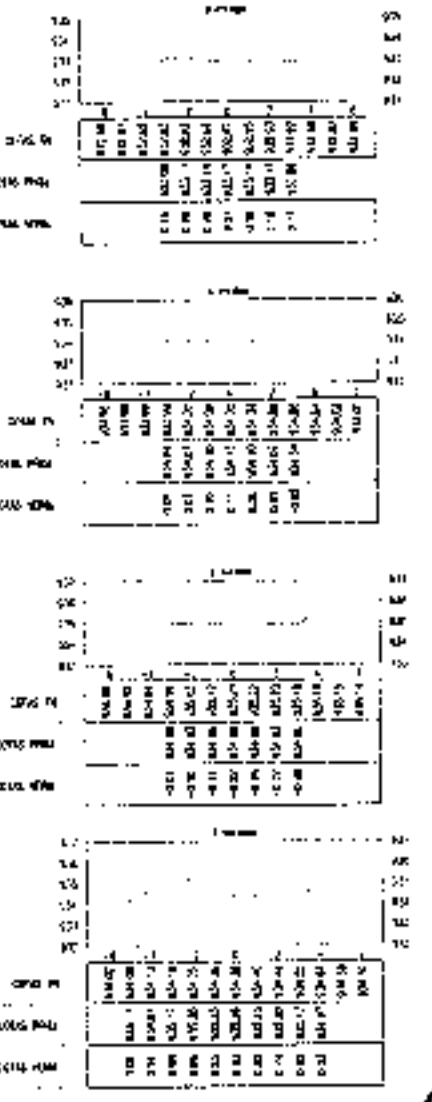
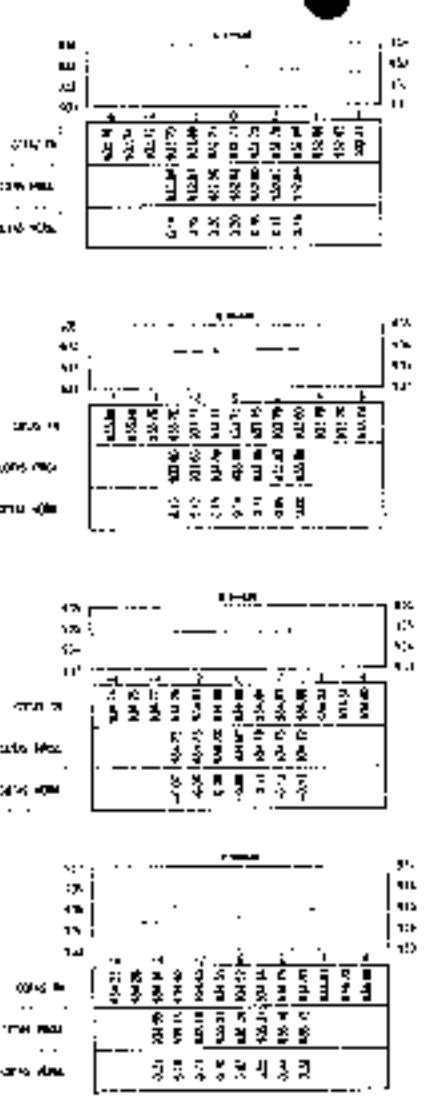
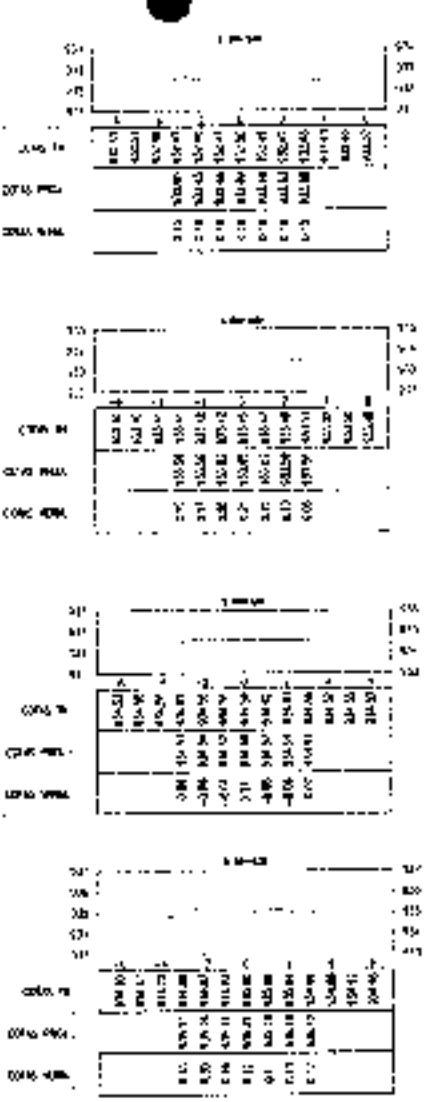
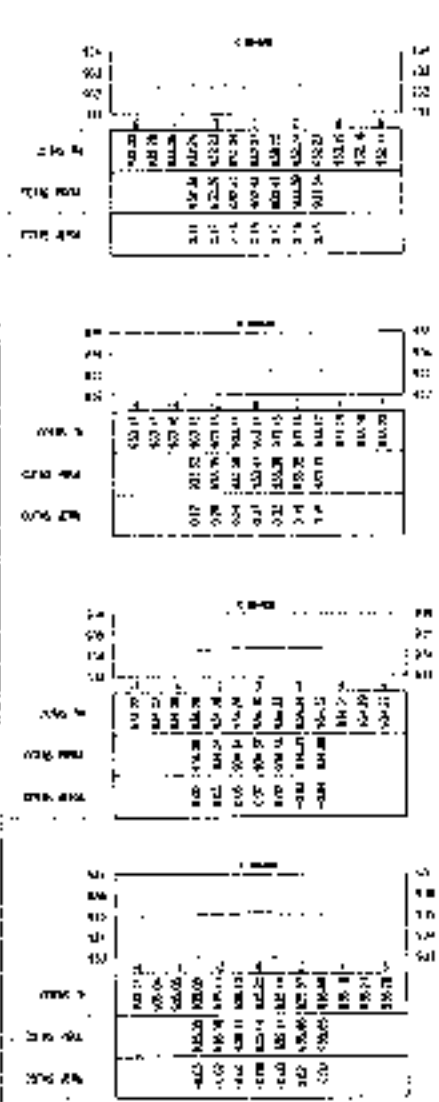

PREFEITURA MUNICIPAL DE GUARACIABA DO NORTE
 RECONSTRUÇÃO DE ESTRADAS VICINAIS NO MUNICÍPIO DE GUARACIABA
 DO NORTE-CE - PT. 1086270-03
 SEÇÕES TRANSVERSAIS

7113
 1/50



LEGENDA:

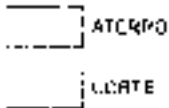

PROFITEIRA MUNICIPAL DE GUARACIABA DO NORTE
 RECUPERAÇÃO DE ESTRADAS VICINA E NO MUNICIPIO DE GUARACIABA
 DO NORTE-CE - PT 1066270-03
SEÇÕES TRANSVERSAIS
PROJETO: DR. CARLOS ALBERTO FERREIRA TORRES - CREA 15.808/95
 EXECUÇÃO: DR. MARCELO SOARES DE ARAUJO - CREA 15.808/95

8 / 13
 1050

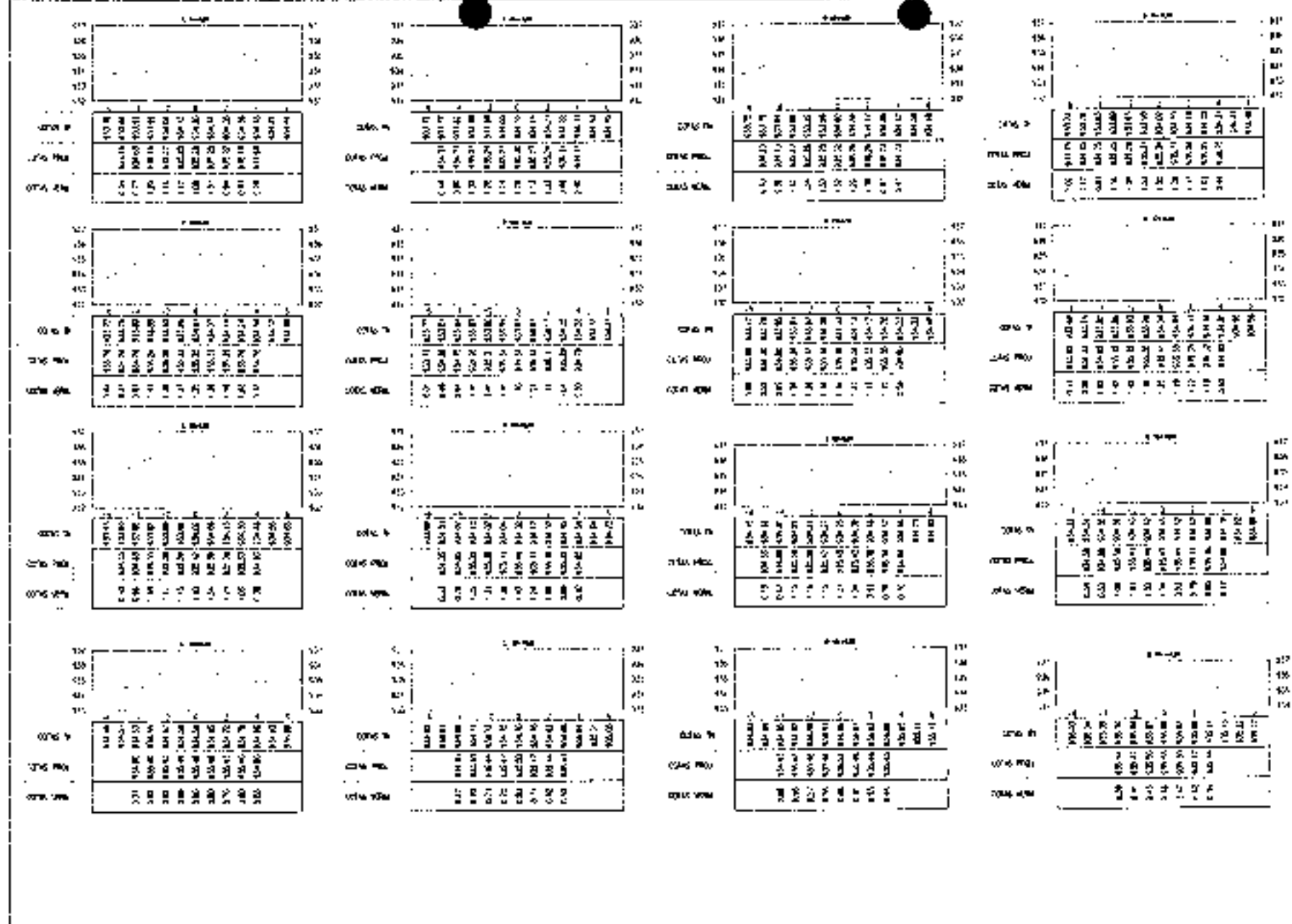

LEGENDA

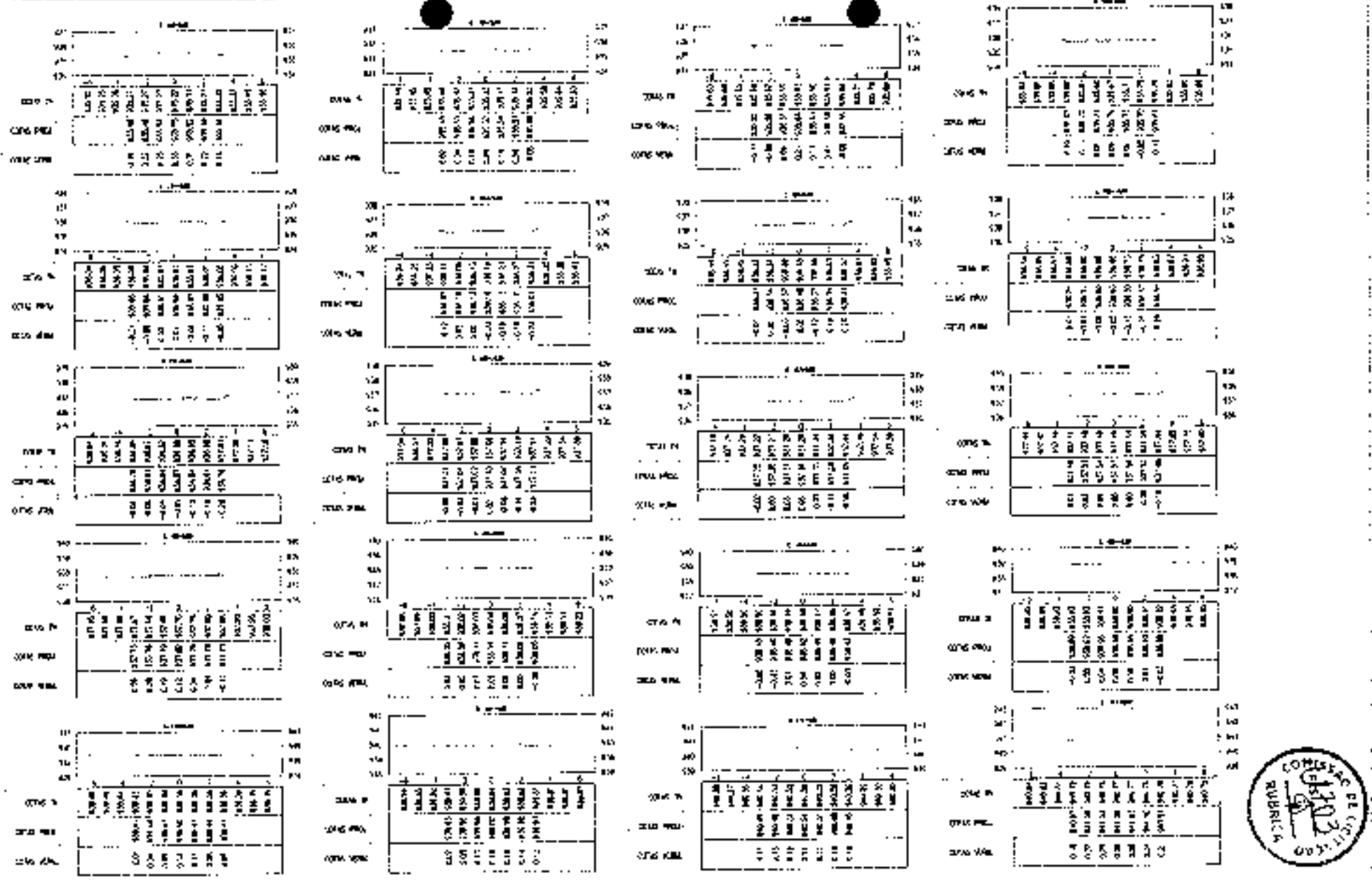
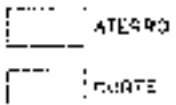

PREFEITURA MUNICIPAL DE GUARACIABA DO NORTE
 RECUPERAÇÃO DE ESTRADAS VICINAIS NO MUNICÍPIO DE GUARACIABA
 DO NORTE - CE - PI 108620403

SEÇÕES TRANSVERSAIS

9 / 13

1250



LEGENDA

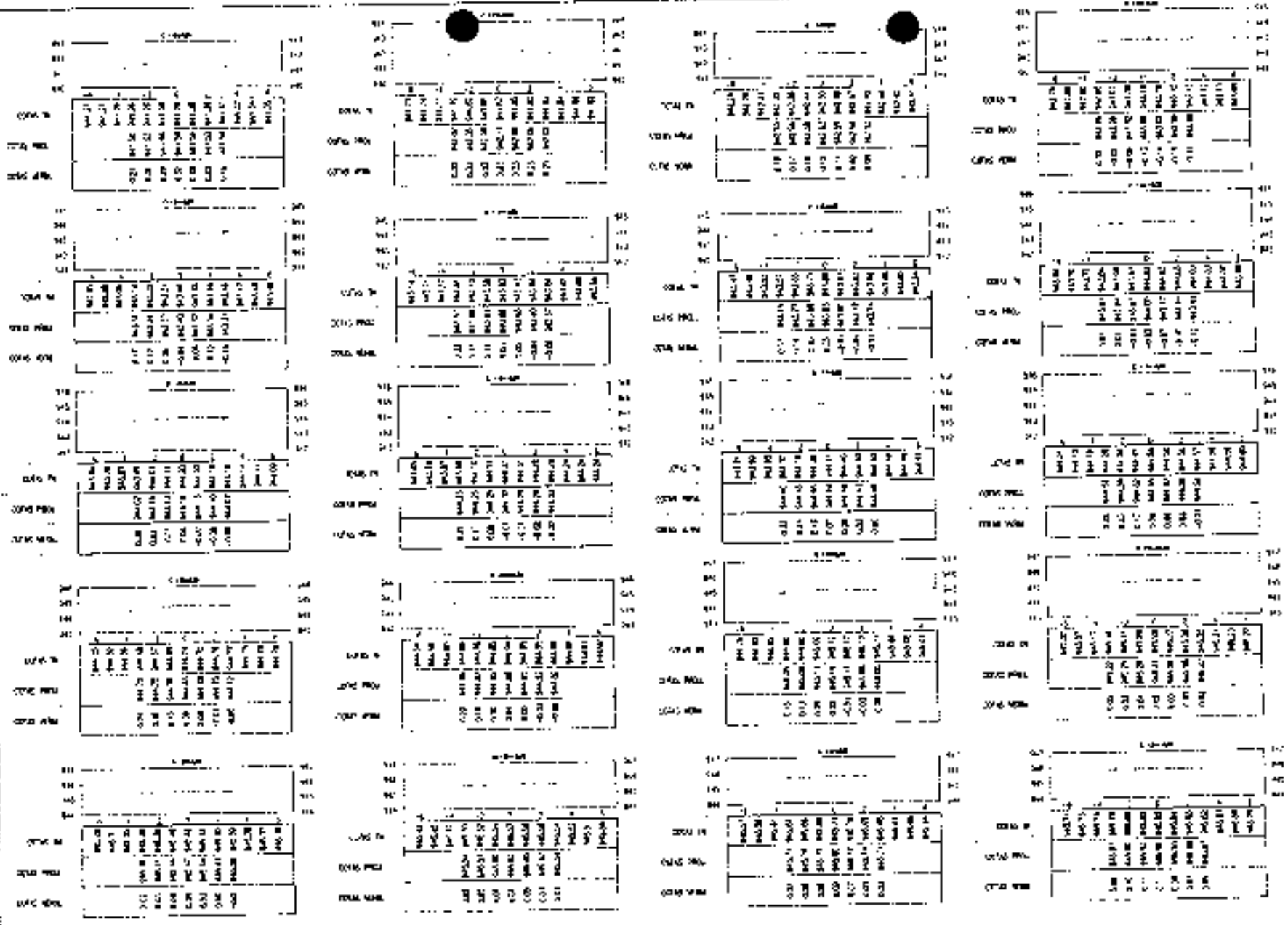
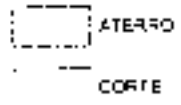

PREFEITURA MUNICIPAL DE GUARACIARA DO NORTE
 RECUPERAÇÃO DE ESTRADAS RURAIS NO MUNICÍPIO DE GUARACIARA DO NORTE-CE - Nº 1086270-D3
 SEÇÕES TRANSVERSAIS
 ESCALA: 1:1000
 DATA: 10/13



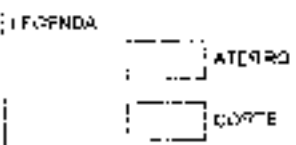
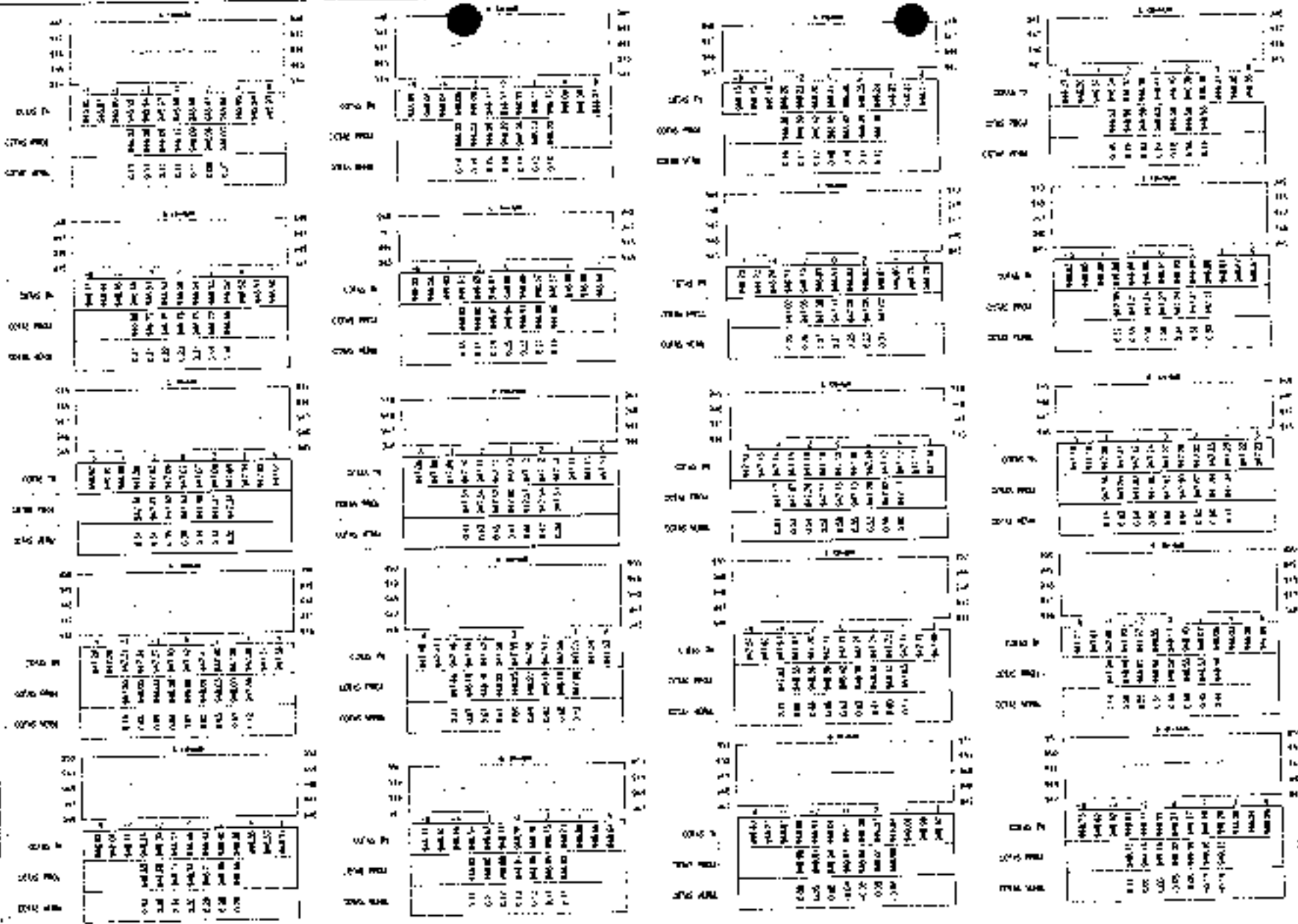

10 / 13

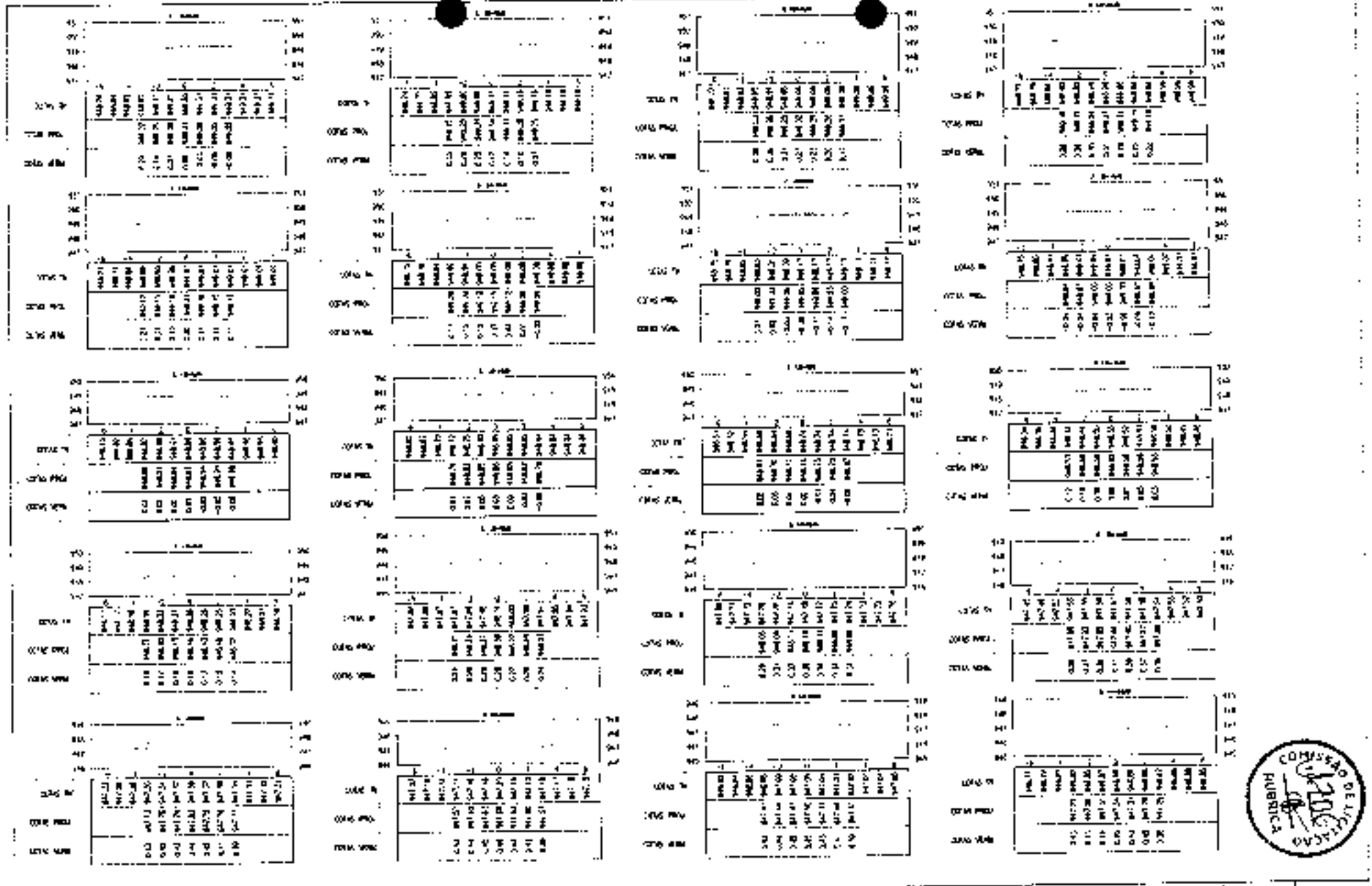
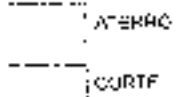

PREFEITURA MUNICIPAL DE GUARACIABA DO NORTE RECUPERAÇÃO DE ESTRADAS LOCAIS NO MUNICÍPIO DE GUARACIABA DO NORTE-CE - PT 1095273-03 BLOCOS TRANSVERSAIS		11 / 13 1994
escala: 1:500 data: 02/08/94	PROJ. CIVIL: ENG.º F. MARCELO TORRES DE ARAÚJO PROJ. ARQ.: ENG.º CARLOS ALBERTO DE ARAÚJO TORRES DE ARAÚJO	U.S.C.

LEGENDA





 <p>JOTA BARROS R. D. 7 - C. 0</p>	<p>PREFEITURA MUNICIPAL DE GUARACIABA DO NORTE</p> <p>RECONSTRUÇÃO DE ESTRADAS VICINAIS NO MUNICÍPIO DE GUARACIABA</p> <p>CO. NORTE-03 - PT. 1085270-03</p> <p>SEÇÕES TRANSVERSAIS</p>		<p>12 / 13</p>
	<p>PROJETO</p> <p>PROJ. Nº</p>	<p>DE: ENG. CIVIL MONTENEGRO - 1982 - 1983</p> <p>ELABORADO POR: ENGENHEIRO MONTENEGRO - 1982 - 1983</p>	





	PREFEITURA MUNICIPAL DE GUARACIMBA DO NORTE		13 / 13
	RECUPERAÇÃO DE ESTRADAS VICINAIS NO MUNICÍPIO DE GUARACIMBA DO NORTE - CE - PL 1005/70-03		1/200
PROPOSTA	EM CONFORMIDADE COM O PROJETO DE ARQUITETURA		
PROJETO	DE FUNDAMENTAÇÃO PARA A CONSTRUÇÃO DE OBRAS DE RECONSTRUÇÃO		

LEGENDA
 **ATERRO**
 **COIRTE**

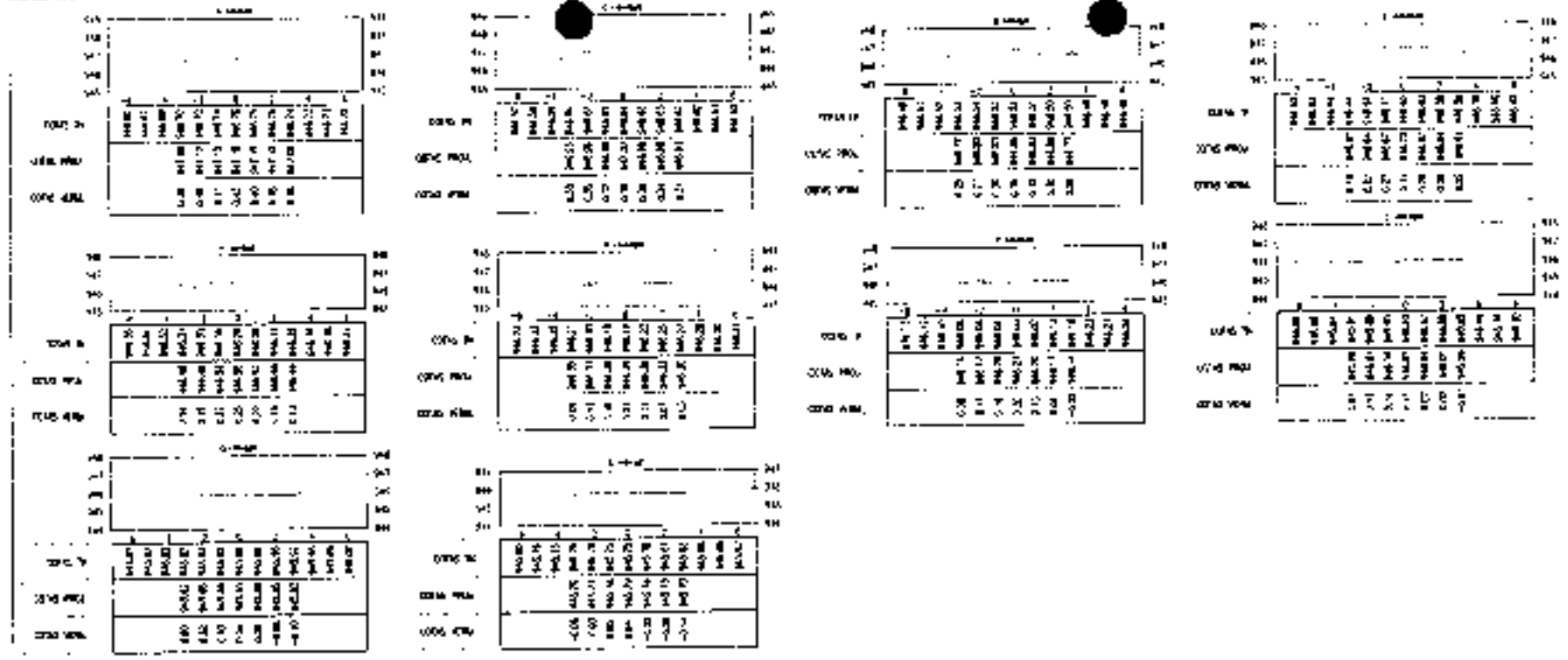

0 1000 2000

0 1000 2000

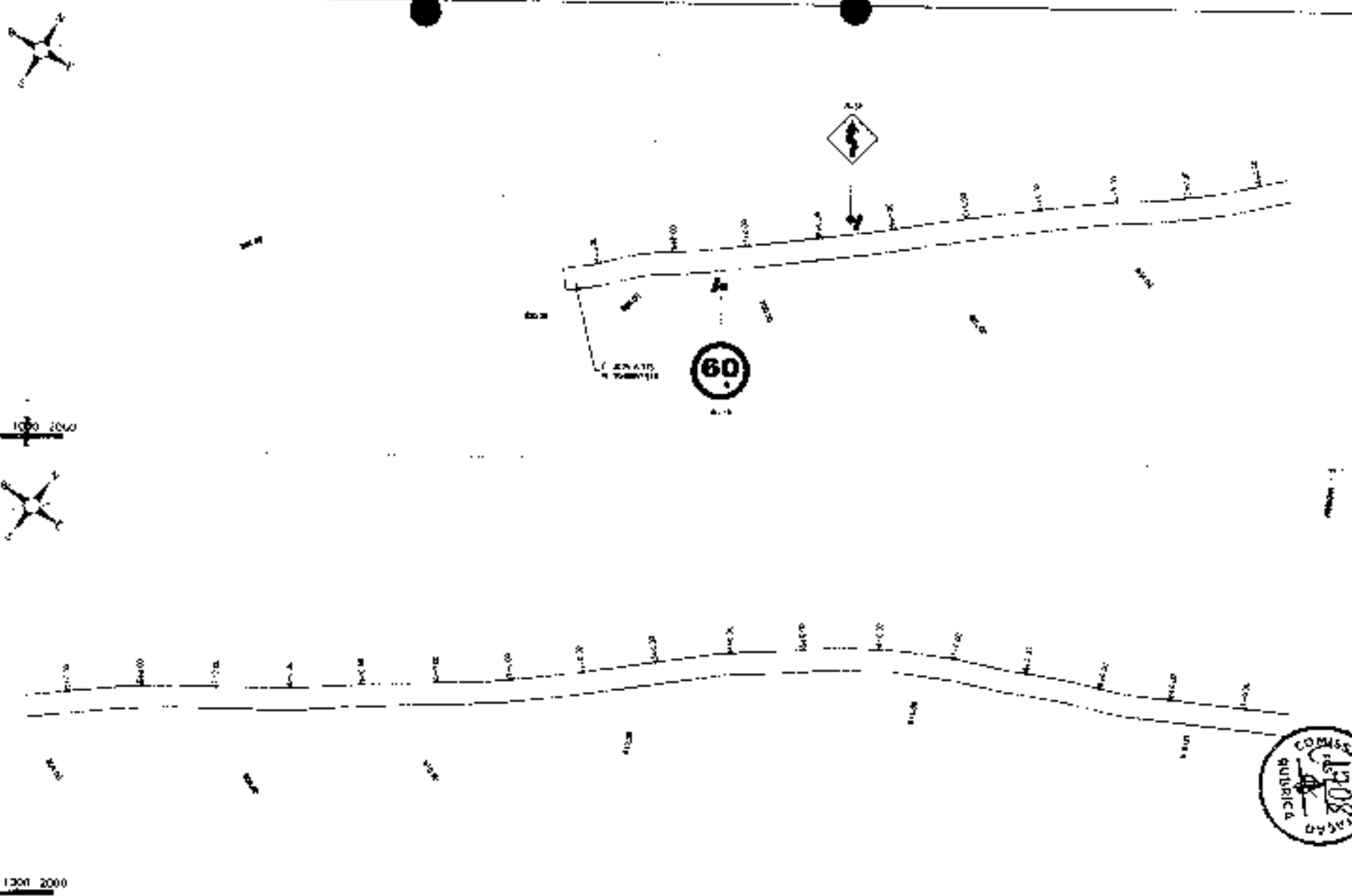

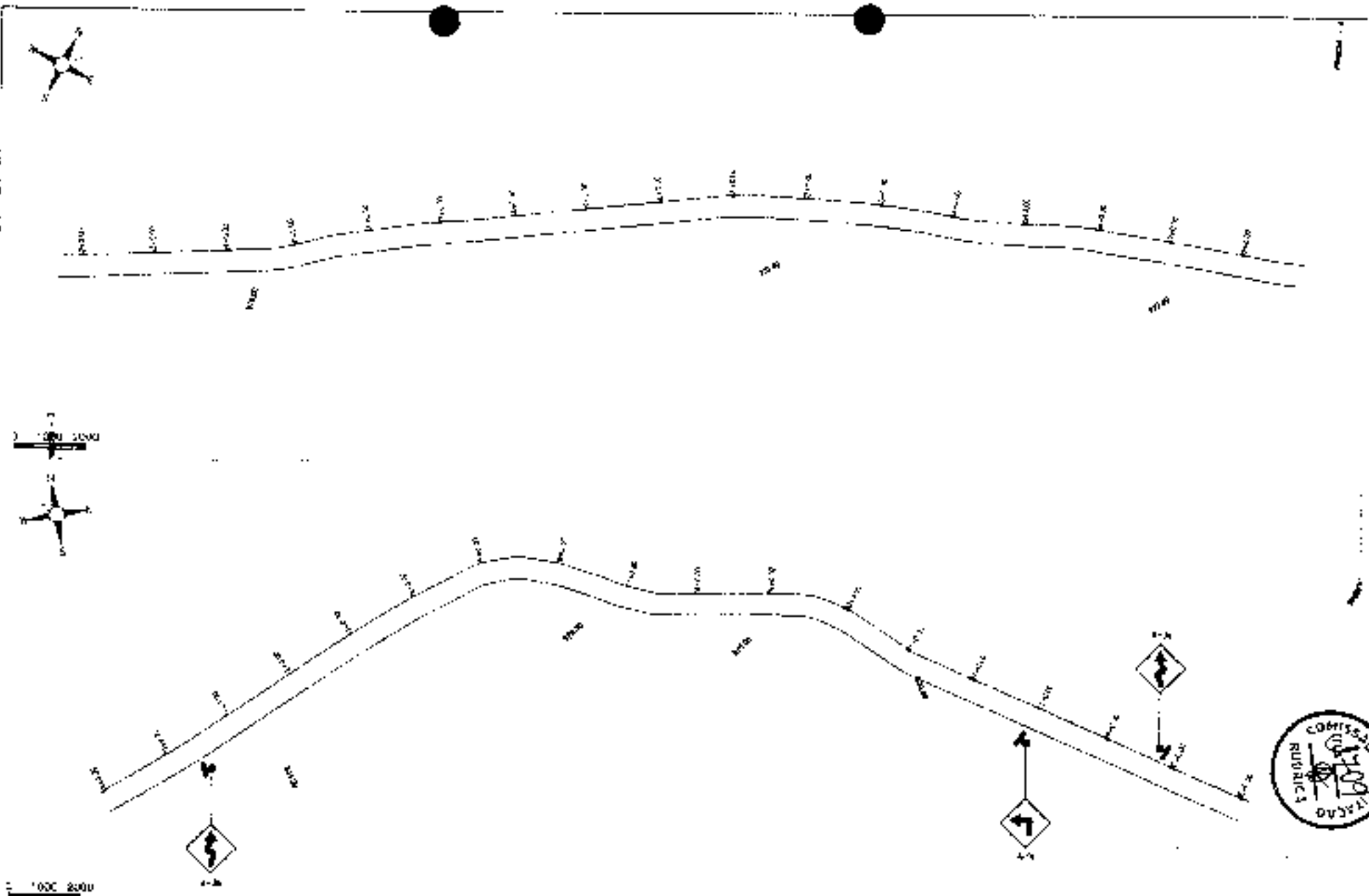

PREFEITURA MUNICIPAL DE GUARACIABA DO NORTE		1705
RECLPERAÇÃO DE ESTRADAS VICINAIS NO MUNICIPIO DE GUARACIABA DO NORTE-CE - PT 138670-03		
SINALIZAÇÃO VIÁRIA		
PROJETO	DETA. DE SINALIZAÇÃO VIÁRIA (SINALIZAÇÃO DE SINALIZAÇÃO VIÁRIA)	1:100
PROJETO	DE SINALIZAÇÃO VIÁRIA (SINALIZAÇÃO DE SINALIZAÇÃO VIÁRIA)	

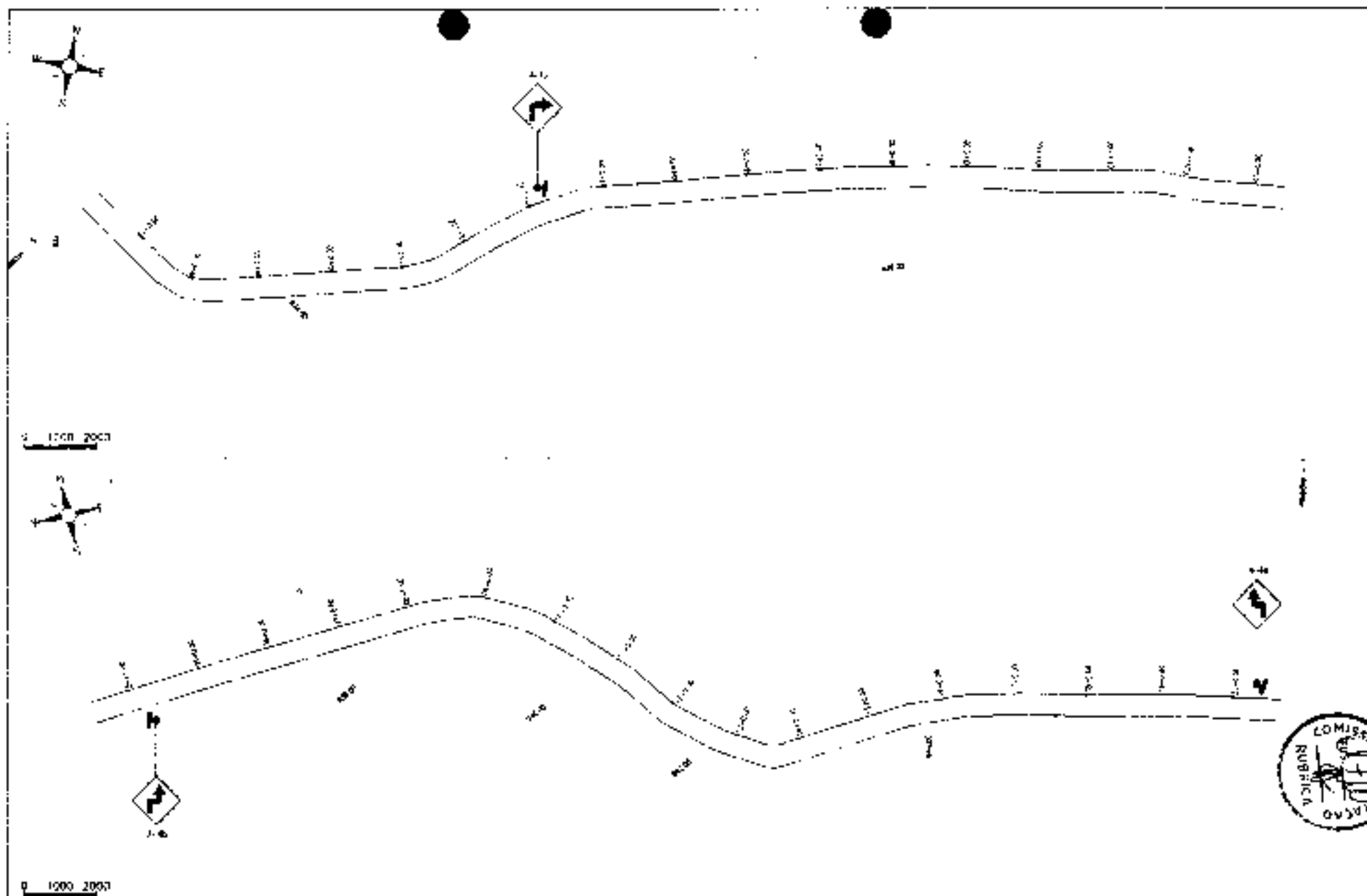

1000 2000

	PREFEITURA MUNICIPAL DE GUARAGUÁ DO NORTE		2 / 05
	RECUPERAÇÃO DE ESTRADAS VICINAIS NO MUNICÍPIO DE GUARAGUÁ DO NORTE - PE - 1096270-03		12/000
	SINALIZAÇÃO VIÁRIA		
PROJETO	LUIS CARLOS VIEIRA MOREIRA TRANQUILIN...		
APROVAÇÃO	ALFONSO...		



	PREFEITURA MUNICIPAL DE GUARACABA DO NORTE		DATA:
	RECUPERAÇÃO DE ESTRADAS VICINAIS NO MUNICÍPIO DE GUARACABA DO NORTE - OF - PT 1066270-03		3 / 05
	SINALIZAÇÃO VIÁRIA		ESCALA:
	1:5000		1:5000

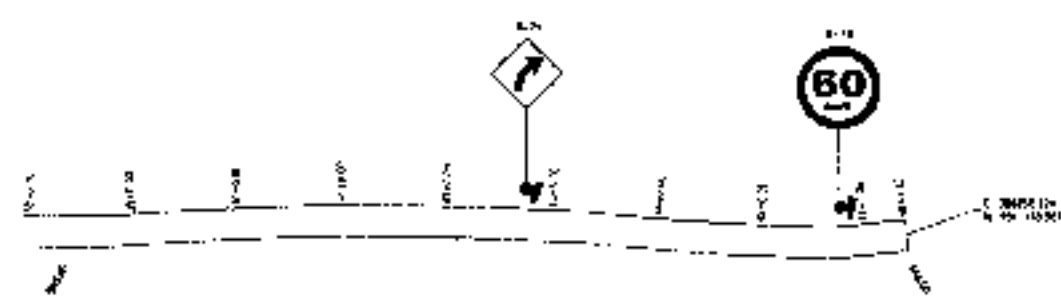
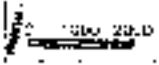
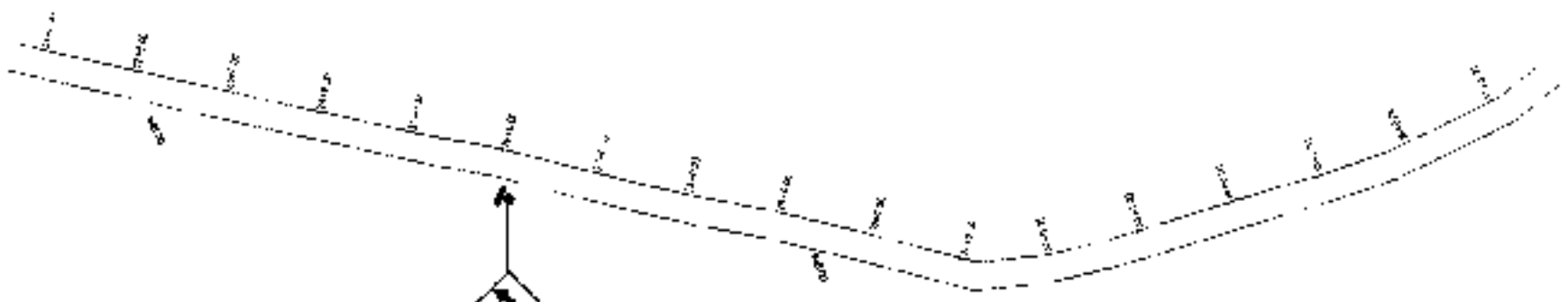

PREFEITURA MUNICIPAL DE GUARACIABA DO NORTE		DATA
RECUPERAÇÃO DE ESTRADAS VICINAIS NO MUNICÍPIO DE GUARACIABA DO NORTE - CE - P.º 086270-03		4 / 05
SINALIZAÇÃO VIÁRIA		DESCRIÇÃO
PROPOSTA	PROPOSTA Nº 086270-03	1.º DE 05
PROVA	PROVA Nº 086270-03	

Posicionamento transversal

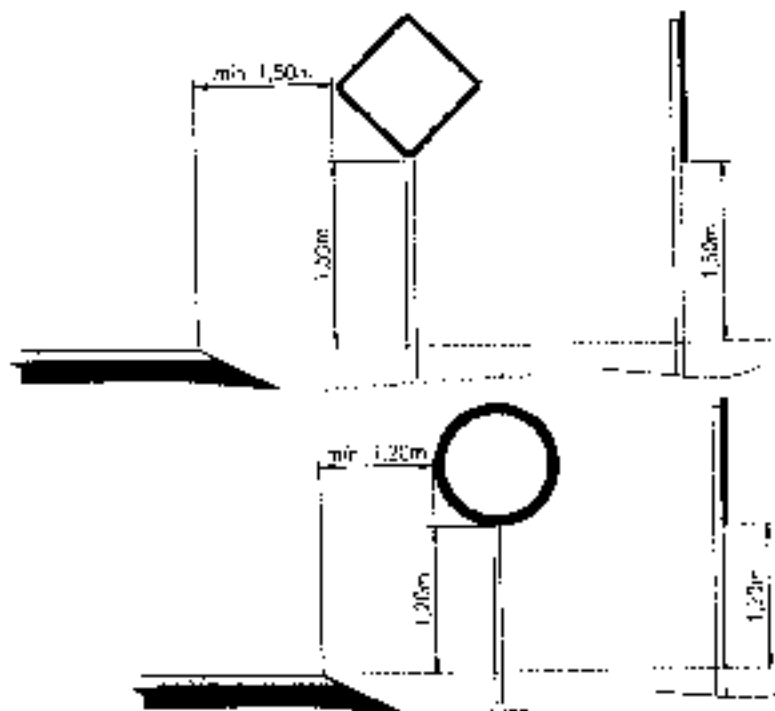

PLACAS DE ADVERTÊNCIA

PLACAS	CÓDIGO DESCRICÃO	PLACAS	Quantidade
	021	021	1
	022	022	1
	023	023	1
	024	024	1
	025	025	1
	026	026	1
	027	027	1
	028	028	1

PLACAS DE ADVERTÊNCIA

PLACAS	CÓDIGO	QUANTIDADE	Quantidade
	029	029	1

As placas de advertência tem as seguintes medidas:

021 - 0,30m x 0,30m
022 - 0,30m x 0,30m
023 - 0,30m x 0,30m
024 - 0,30m x 0,30m
025 - 0,30m x 0,30m
026 - 0,30m x 0,30m
027 - 0,30m x 0,30m
028 - 0,30m x 0,30m

As Placas de Advertência tem as seguintes medidas:

029 - 0,30m x 0,30m
030 - 0,30m x 0,30m
031 - 0,30m x 0,30m
032 - 0,30m x 0,30m
033 - 0,30m x 0,30m
034 - 0,30m x 0,30m
035 - 0,30m x 0,30m
036 - 0,30m x 0,30m



PREFEITURA MUNICIPAL DE GUARACABA NORTE
 RECUPERAÇÃO DE ESTRADAS VICINAIS NO MUNICÍPIO DE GUARACABA DO NORTE-CE - P. 108270-03
 SINALIZAÇÃO VIÁRIA

PROPOSTA Nº 001/2015
 VALOR R\$ 1.000,00

5 / 05
 SFV ESC



1:1000

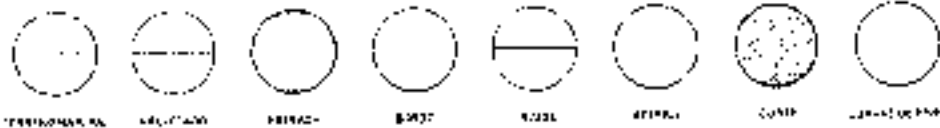
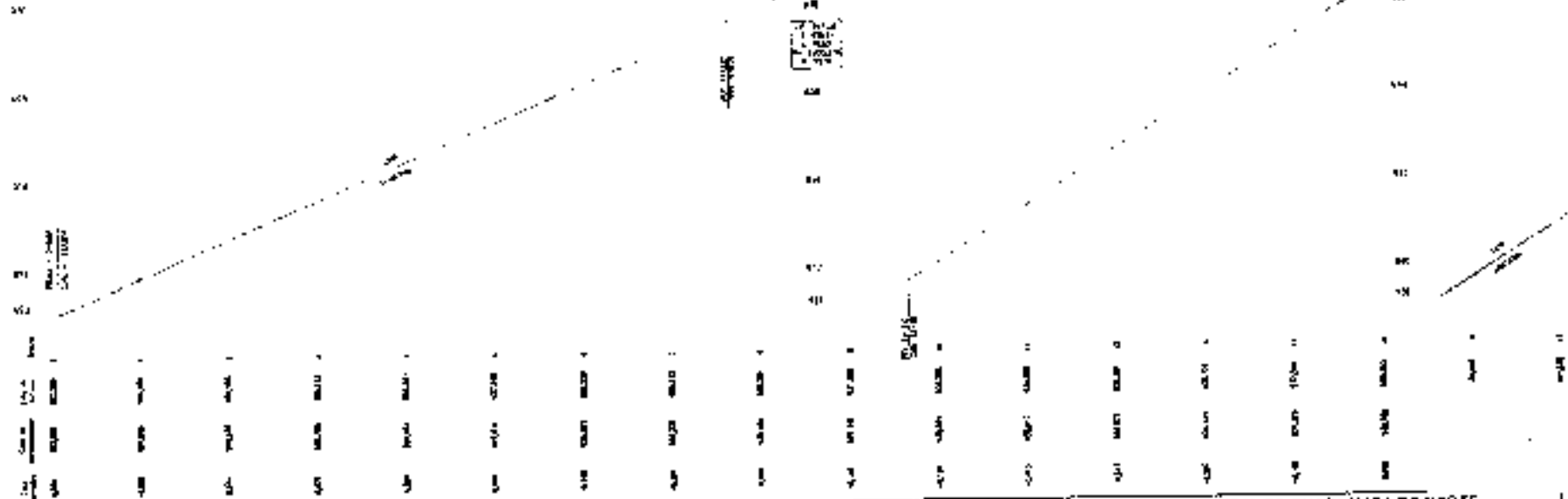

PREFEITURA MUNICIPAL DE GUARACIABA DO NORTE
 RECUPERAÇÃO DE ESTRADAS VICINAIS NO MUNICÍPIO DE GUARACIABA DO NORTE-CE - PT 10862/040
 ESTAGUEAMENTO E PERFIL LONGITUDINAL
 ELABORADO POR: [Nome do Engenheiro]
 DATA: [Data]



Nº: 1/08
 DATA: 11/10/08
 V. 1/12



0 10,00 20,00

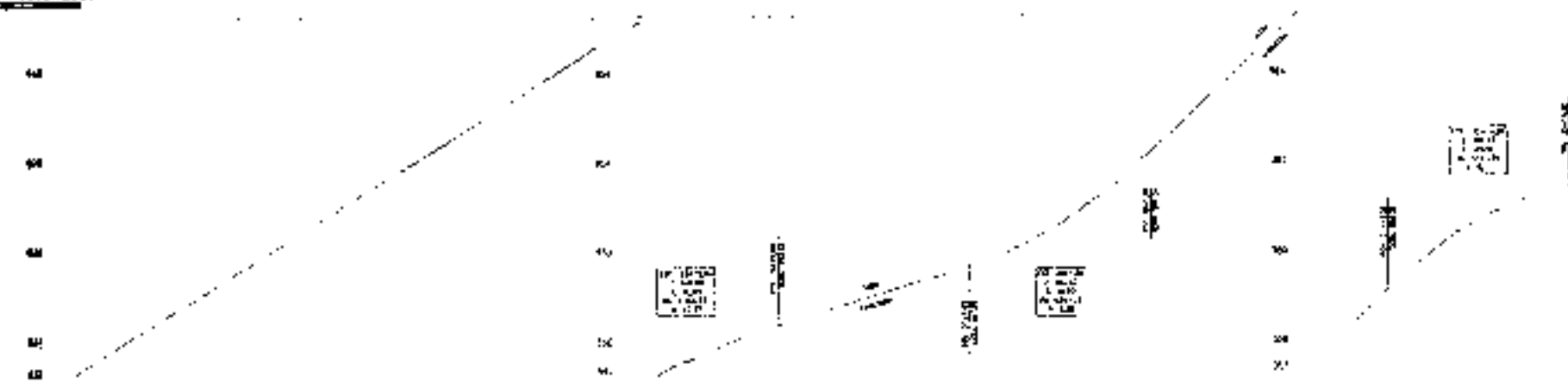
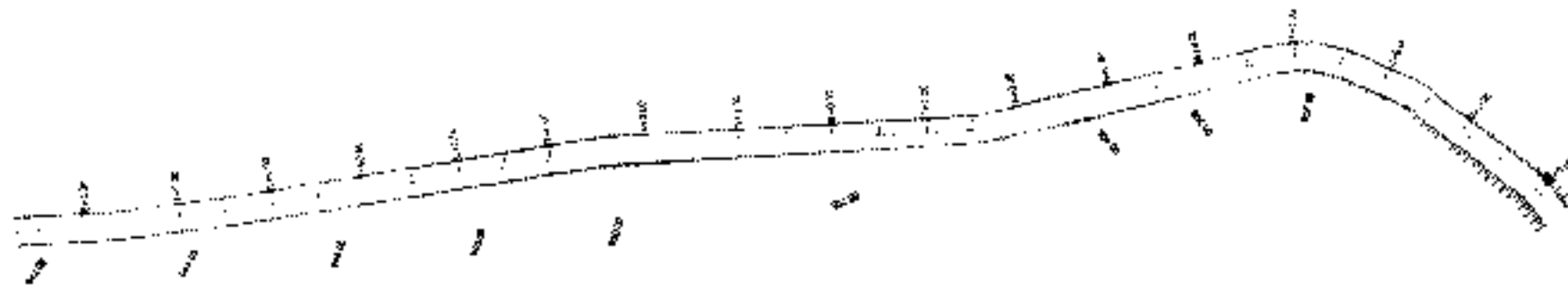

0+00	0+10	0+20	0+30	0+40	0+50	0+60	0+70	0+80	0+90	1+00
10,00	10,00	10,00	10,00	10,00	10,00	10,00	10,00	10,00	10,00	10,00
10,00	10,00	10,00	10,00	10,00	10,00	10,00	10,00	10,00	10,00	10,00

PERFIL GERAL DRENAGEM ESTACÃO GUTTER CORTA-VENTO PAVIMENTO COTAGEM



PREFEITURA MUNICIPAL DE GUARACIABA DO NORTE
 RECUPERAÇÃO DE ESTRADAS VICINAIS NO MUNICÍPIO DE GUARACIABA DO NORTE-CE - PT 108527E-03
 ESTADUEAMENTO E PERFIL LONGITUDINAL

ALTERNATIVA	03 - COM VARIACIONES DE GEOMETRIA DE TRANSITO
PROJETO	PROJETO DE ESTADUEAMENTO E PERFIL LONGITUDINAL



FOLHA Nº 2 / 08
 DATA 11/11/2023
 V 1:12Z



0 1000 2000

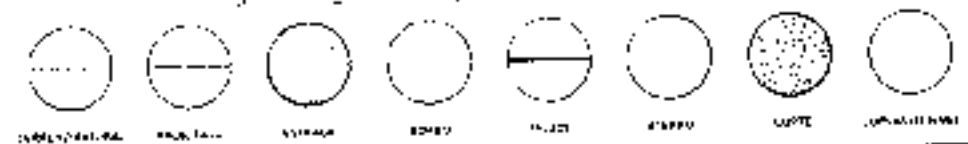
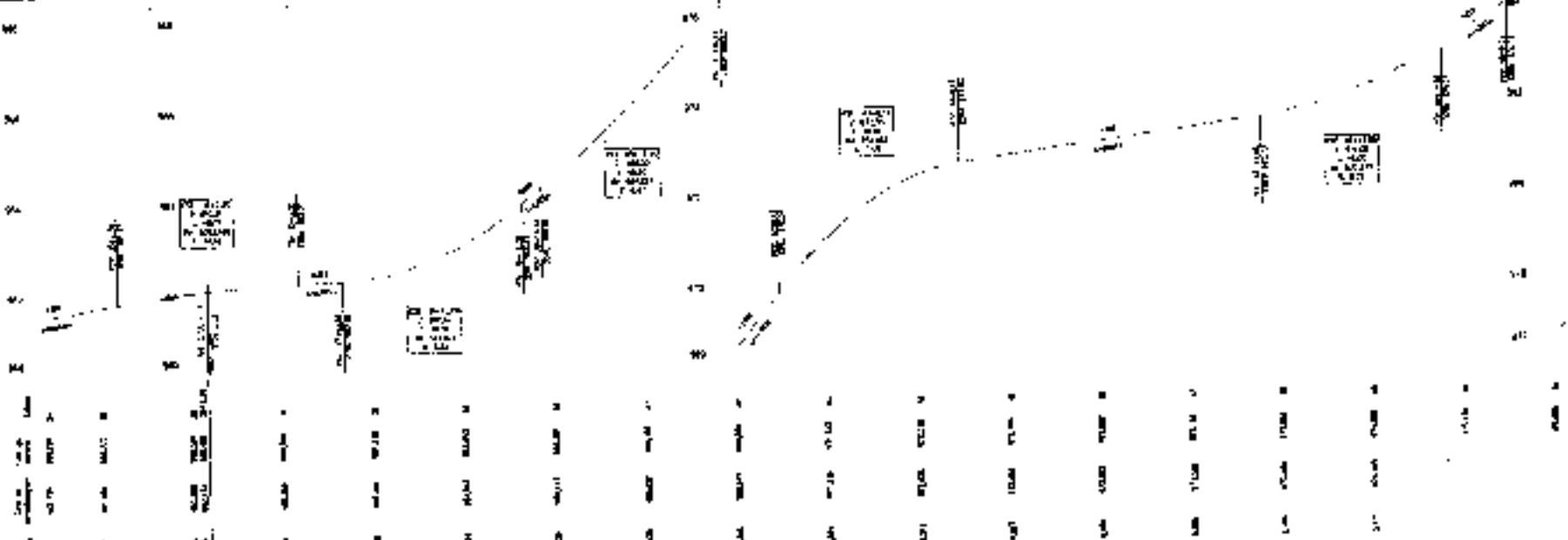

PREFEITURA MUNICIPAL DE GUARACIABA DO NORTE

RECUPERAÇÃO DE ESTRADAS VICINAIS NO MUNICÍPIO DE GUARACIABA DO NORTE-CE - PT 1086270400

ESTAQUEAMENTO E PERFIL LONGITUDINAL

PROJETA: DR. CARLOS ALBERTO FERREIRA DE LIMA - ENGENHEIRO

APROVA: CARLOS ALBERTO FERREIRA DE LIMA - ENGENHEIRO



3 / 08

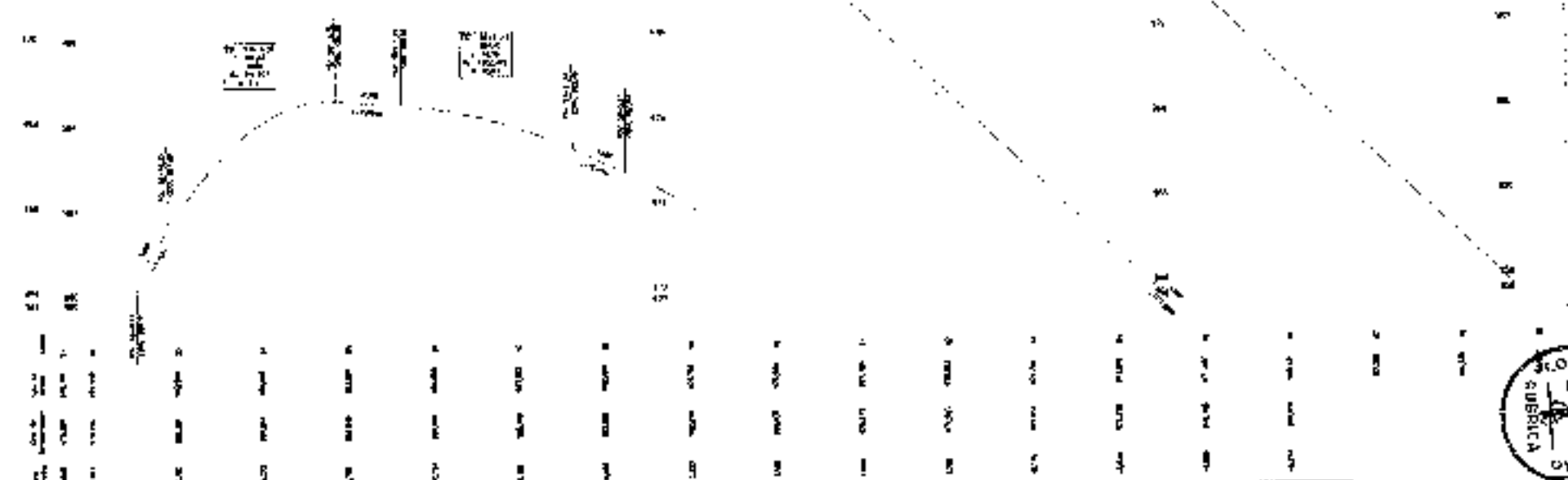
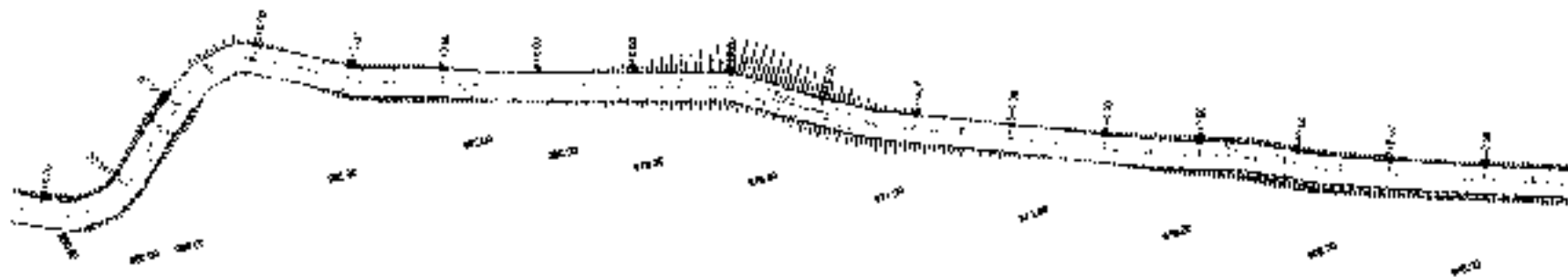

- CONCRETO
- ASFALTO
- TERRA
- CANTO
- DRENAGEM
- DRENAGEM
- DRENAGEM
- DRENAGEM



PREFEITURA MUNICIPAL DE GUARACIABA DO NORTE
RECUPERAÇÃO DE ESTRADAS VICIAIS NO MUNICÍPIO DE GUARACIABA DO NORTE-CE - P1 1086270-03
ESTAQUEAMENTO E PERFIL LONGITUDINAL

PROJETO: [illegible]
 ESCALA: [illegible]



4 / 08
 DATA: [illegible]
 LOCAL: [illegible]

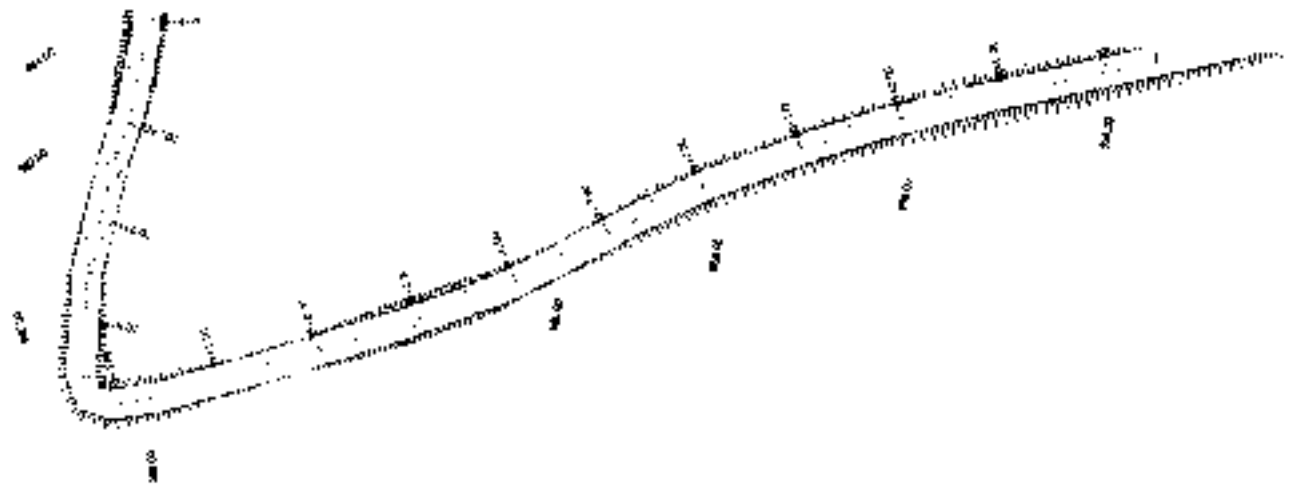
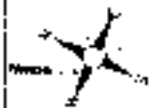

1:500

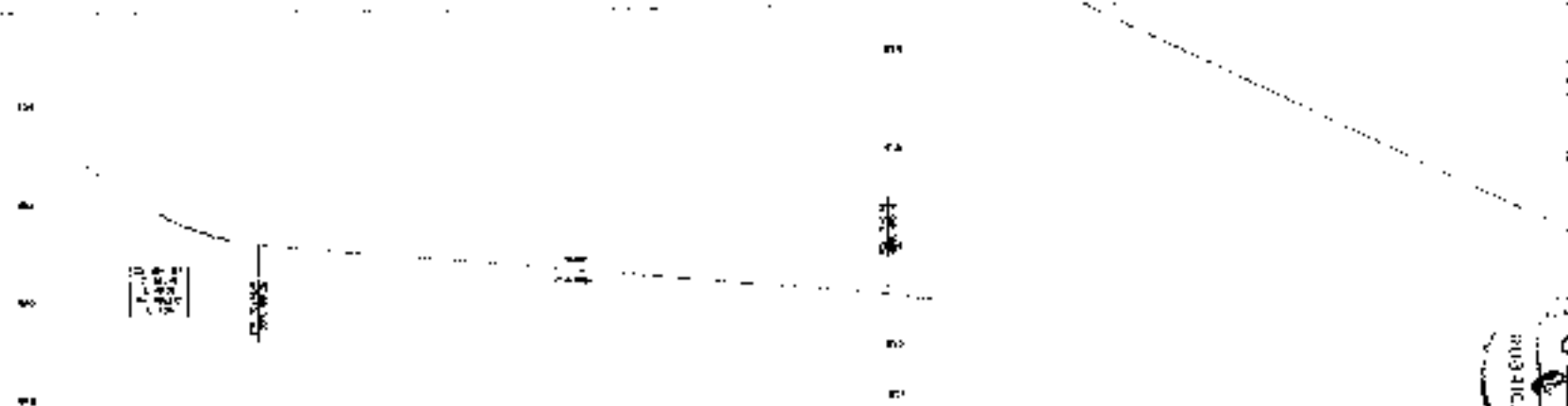

1+00	1+10	1+20	1+30	1+40	1+50	1+60	1+70	1+80	1+90	10	11	12	13	14	15
10.00	10.50	11.00	11.50	12.00	12.50	13.00	13.50	14.00	14.50	10	11	12	13	14	15
10.00	10.50	11.00	11.50	12.00	12.50	13.00	13.50	14.00	14.50	10	11	12	13	14	15



PREFEITURA MUNICIPAL DE GUARACIABA DO NORTE	
RECONSTRUÇÃO DE ESTRADAS VICINAIS NO MUNICÍPIO DE GUARACIABA DO NORTE - RPT 1006276-02	
ESTAQUEAMENTO E PERFIL LONGITUDINAL	
PROJETA	PROFESSOR CARLOS ALBERTO DE SOUZA
PROJETO	FABRIL DE LAMINADOS S/A - RUA CARLOS ALBERTO



5 / 08
 14/11/2002
 14/11/02

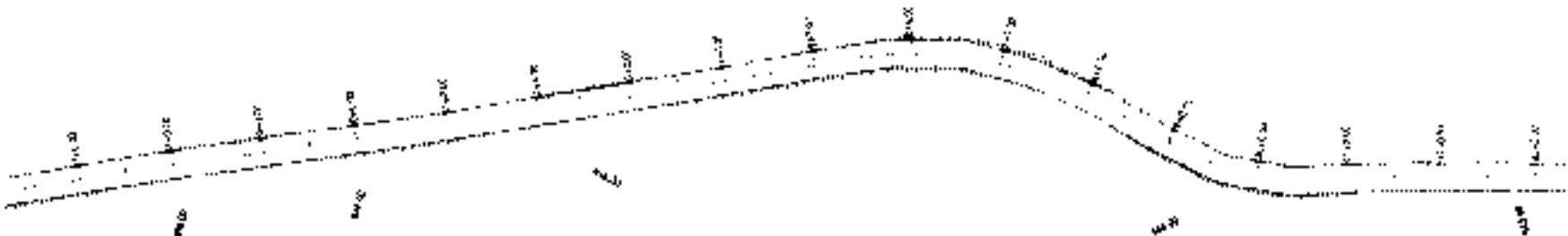

1:500 20/00

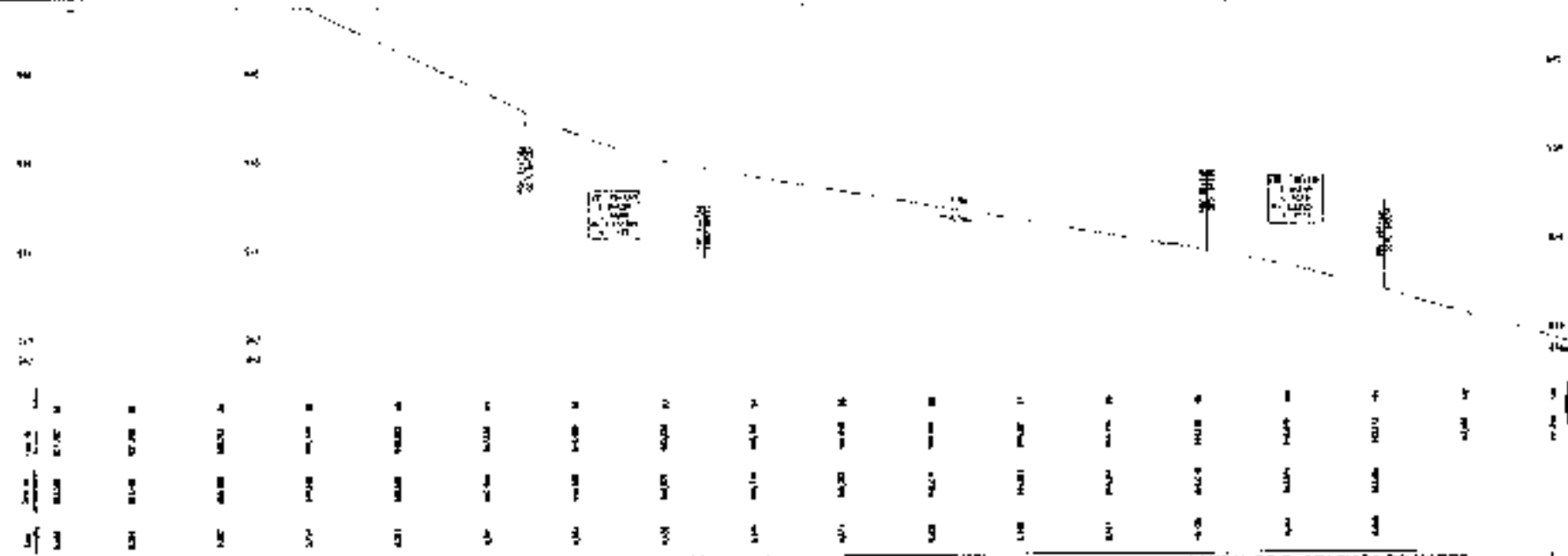

-  LINHA CENTRAL
-  LARGURA
-  CANTO
-  TERRENO
-  ALTITUDE
-  ESTACADA
-  PENTE
-  LARGURA



PREFEITURA MUNICIPAL DE GUARACIABA DO NORTE REQUALIFICAÇÃO DE ESTRADAS VICINAIS NO MUNICÍPIO DE GUARACIABA DO NORTE - CE - PT 1088770-02 ESTAQUEAMENTO E PERFIL LONGITUDINAL	
PROJETO	DR. CARLOS AUGUSTO FERREIRA DE MENEZES
MUNICÍPIO	GUARACIABA DO NORTE - CE







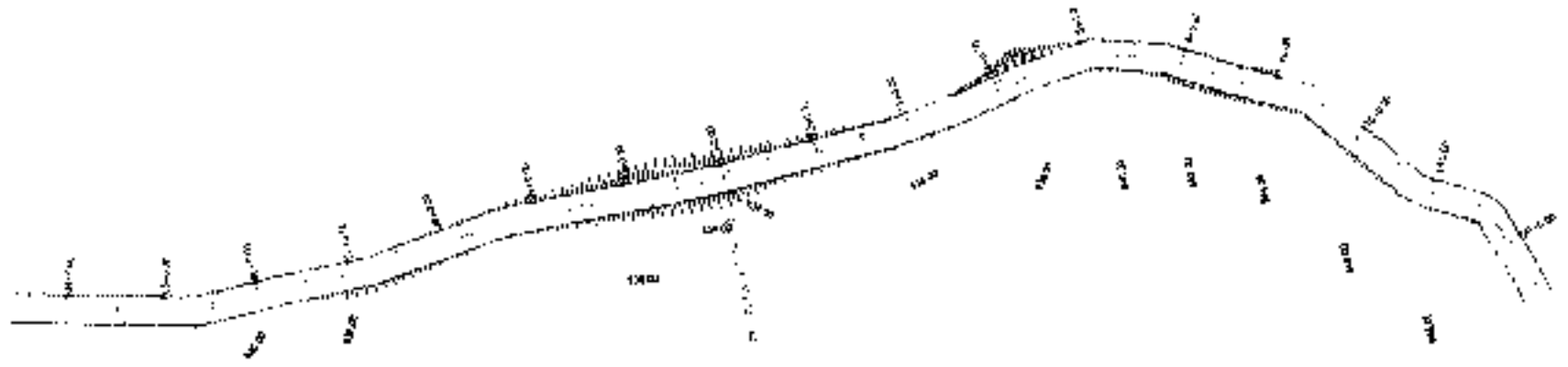

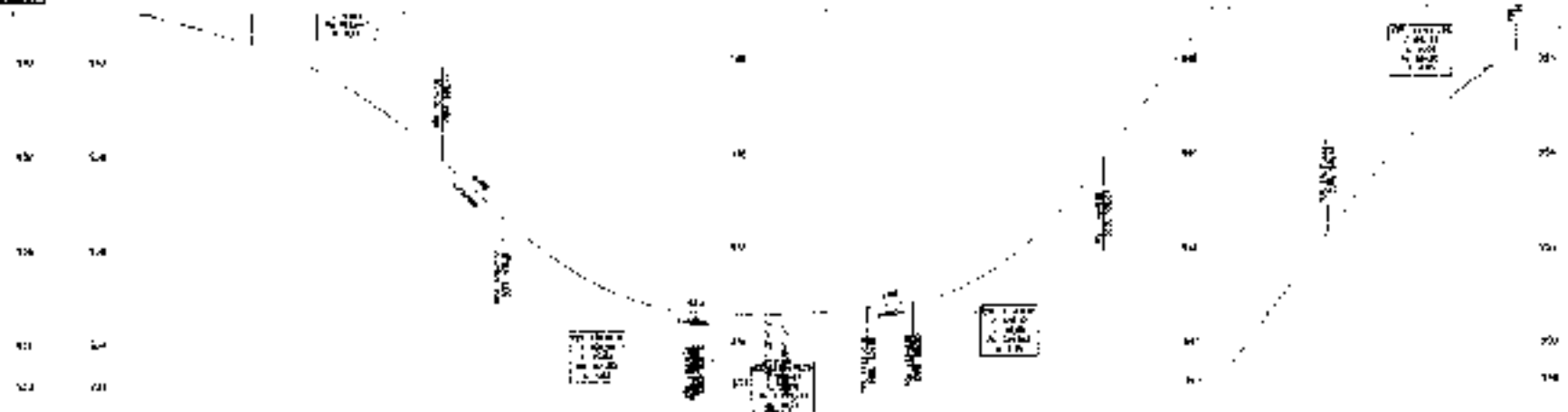

6 / 08

2015



1:1000



- 
 RUA EXISTENTE
- 
 RUA A SER PAVIMENTADA
- 
 RUA A SER AMPLIADA
- 
 RUA A SER FECHADA
- 
 RUA A SER ABERTA
- 
 RUA A SER AMPLIADA
- 
 RUA A SER FECHADA
- 
 RUA A SER ABERTA



PREFEITURA MUNICIPAL DE GUARACIABA DO NORTE

RECUPERAÇÃO DE ESTRADAS VICINAIS NO MUNICÍPIO DE GUARACIABA DO NORTE - CE - PT 1306273-03

ESTADUEAMENTO E PERFIL LONGITUDINAL

PROJETO	PROJ. DE RECUPERAÇÃO DE ESTRADAS VICINAIS
PROJETO	PROJ. DE RECUPERAÇÃO DE ESTRADAS VICINAIS



7 / 08

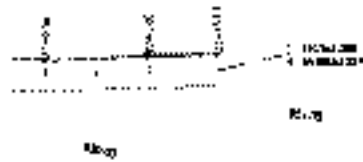

0 1000 2000

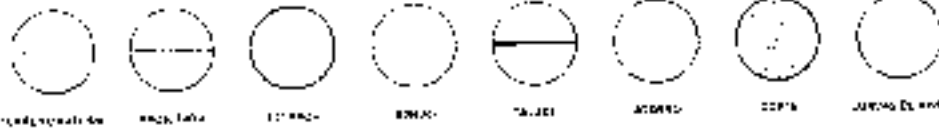

	PREFEITURA MUNICIPAL DE GUARACIABA DO NORTE RECUPERAÇÃO DE ESTRADAS VICINAIS NO MUNICÍPIO DE GUARACIABA DO NORTE-CE - P1 1096270-00		Nº 108 H 1/1000 J 111E
	ESTACIAMENTO E PÉRIL LONGITUDINAL		
PROJETISTA OIA BARROS	PROJ. DE ESTACIAMENTO E PÉRIL LONGITUDINAL OIA BARROS		

LEGENDA

ATERRO
CORTE

	PREFEITURA MUNICIPAL DE GUARACIABA DO NORTE RECUPERAÇÃO DE ESTRADAS VICINAIS NO MUNICÍPIO DE GUARACIABA DO NORTE-CE - PT 1086271-01 SEÇÕES TRANSVERSAIS		Folha nº 1 / 15
	ESCALA 1:1000	DATA 11/05/2011	PROJETO RUA 1086271-01

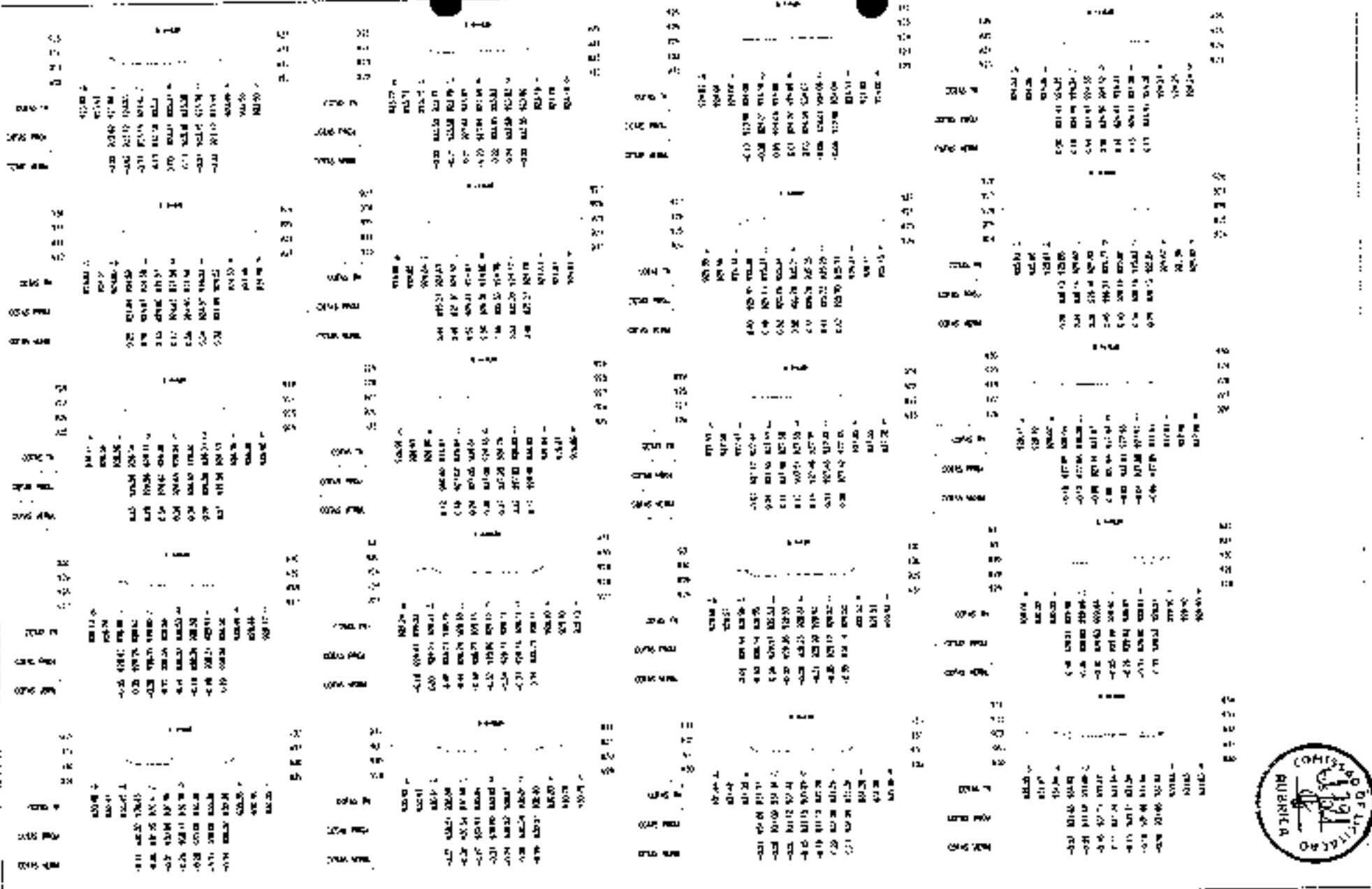



Parcela	Área (m²)	Valor (R\$)	Observações
1	100	10000	...
2	200	20000	...
3	300	30000	...
4	400	40000	...
5	500	50000	...
6	600	60000	...
7	700	70000	...
8	800	80000	...
9	900	90000	...
10	1000	100000	...
11	1100	110000	...
12	1200	120000	...
13	1300	130000	...
14	1400	140000	...
15	1500	150000	...
16	1600	160000	...
17	1700	170000	...
18	1800	180000	...
19	1900	190000	...
20	2000	200000	...
21	2100	210000	...
22	2200	220000	...
23	2300	230000	...
24	2400	240000	...
25	2500	250000	...
26	2600	260000	...
27	2700	270000	...
28	2800	280000	...
29	2900	290000	...
30	3000	300000	...
31	3100	310000	...
32	3200	320000	...
33	3300	330000	...
34	3400	340000	...
35	3500	350000	...
36	3600	360000	...
37	3700	370000	...
38	3800	380000	...
39	3900	390000	...
40	4000	400000	...
41	4100	410000	...
42	4200	420000	...
43	4300	430000	...
44	4400	440000	...
45	4500	450000	...
46	4600	460000	...
47	4700	470000	...
48	4800	480000	...
49	4900	490000	...
50	5000	500000	...

LEGENDA:
 ATERRO
 CORTE



3 / 15
1:250

PREFEITURA MUNICIPAL DE GUARACIABA DO NORTE
 RECUPERAÇÃO DE ESTRADAS VICINAIS NO MUNICÍPIO DE GUARACIABA DO NORTE - RN - P1 1066273-03
 SEÇÃO TRANSEVERSAIS



LEGENDA

ATERRO

CORTE

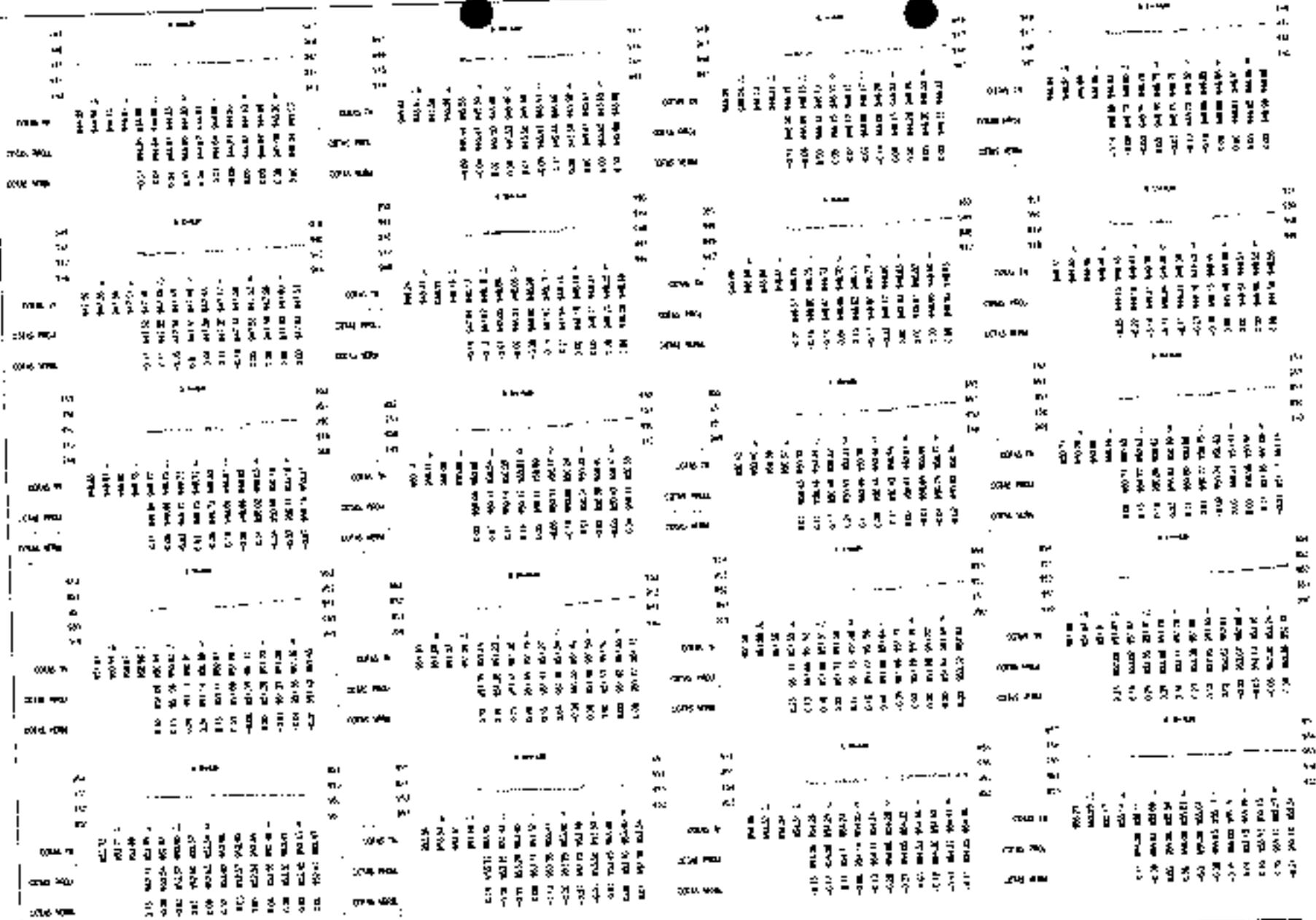

LEGENDA

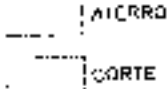

PREFEITURA MUNICIPAL DE GUARACIABA DO NORTE
 REGULAÇÃO DE ESTRADAS VICINAIS NO MUNICÍPIO DE GUARACIABA DO NORTE-CE - Nº 1086270-00
 SEÇÕES TRANSVERSAIS

PROJETO DE REGULAÇÃO DE ESTRADAS VICINAIS - REGULAÇÃO
 PARA O TERMO DE LICITAÇÃO Nº 001/2010 - RFB/CE

4 / 15
 1:250

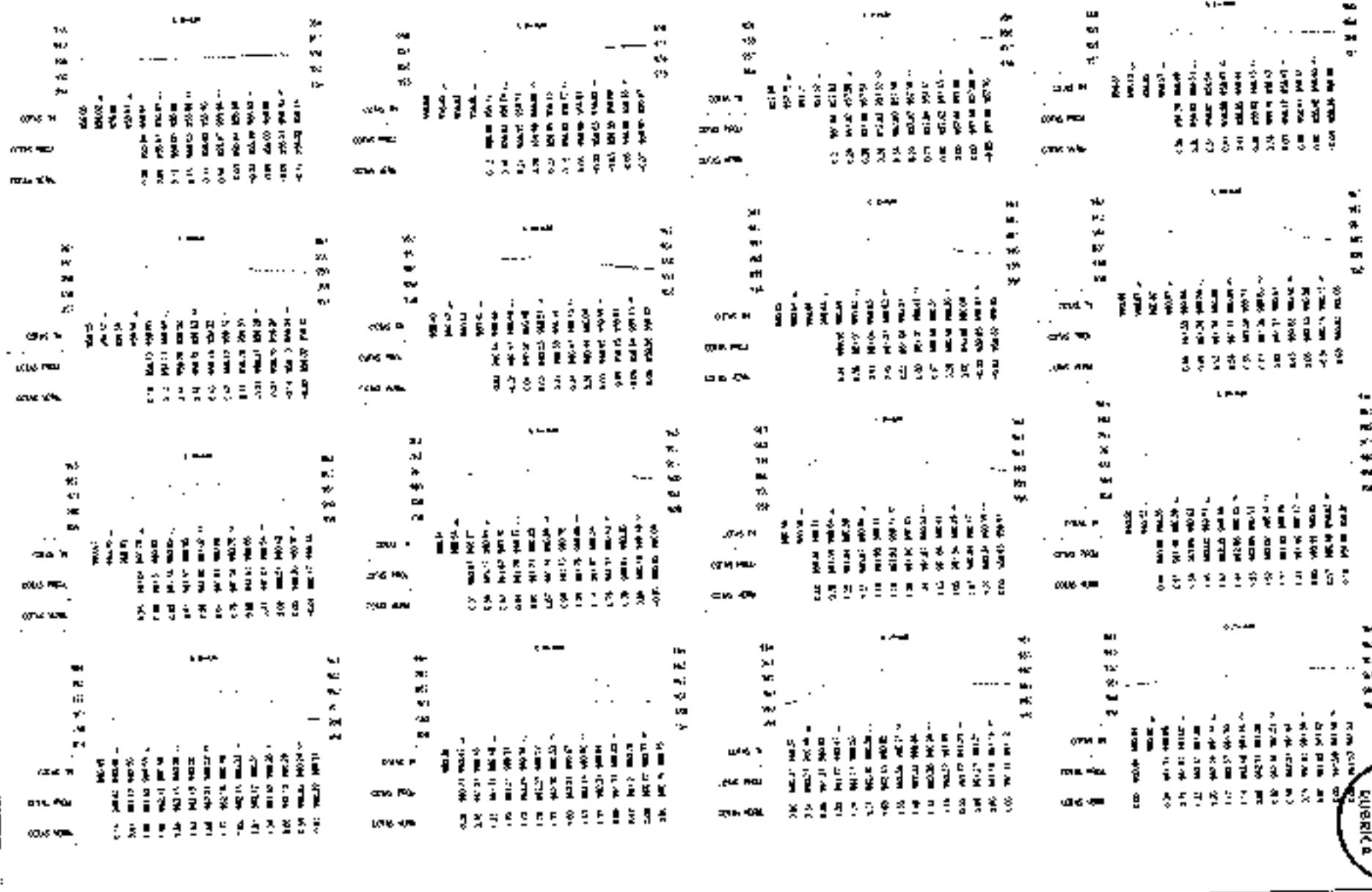

Lote nº		Área (m²)		Valor (R\$)		Observações	
Antes	Depois	Antes	Depois	Antes	Depois	Antes	Depois
100	100	100	100	100	100	100	100
101	101	101	101	101	101	101	101
102	102	102	102	102	102	102	102
103	103	103	103	103	103	103	103
104	104	104	104	104	104	104	104
105	105	105	105	105	105	105	105
106	106	106	106	106	106	106	106
107	107	107	107	107	107	107	107
108	108	108	108	108	108	108	108
109	109	109	109	109	109	109	109
110	110	110	110	110	110	110	110
111	111	111	111	111	111	111	111
112	112	112	112	112	112	112	112
113	113	113	113	113	113	113	113
114	114	114	114	114	114	114	114
115	115	115	115	115	115	115	115
116	116	116	116	116	116	116	116
117	117	117	117	117	117	117	117
118	118	118	118	118	118	118	118
119	119	119	119	119	119	119	119
120	120	120	120	120	120	120	120
121	121	121	121	121	121	121	121
122	122	122	122	122	122	122	122
123	123	123	123	123	123	123	123
124	124	124	124	124	124	124	124
125	125	125	125	125	125	125	125
126	126	126	126	126	126	126	126
127	127	127	127	127	127	127	127
128	128	128	128	128	128	128	128
129	129	129	129	129	129	129	129
130	130	130	130	130	130	130	130
131	131	131	131	131	131	131	131
132	132	132	132	132	132	132	132
133	133	133	133	133	133	133	133
134	134	134	134	134	134	134	134
135	135	135	135	135	135	135	135
136	136	136	136	136	136	136	136
137	137	137	137	137	137	137	137
138	138	138	138	138	138	138	138
139	139	139	139	139	139	139	139
140	140	140	140	140	140	140	140
141	141	141	141	141	141	141	141
142	142	142	142	142	142	142	142
143	143	143	143	143	143	143	143
144	144	144	144	144	144	144	144
145	145	145	145	145	145	145	145
146	146	146	146	146	146	146	146
147	147	147	147	147	147	147	147
148	148	148	148	148	148	148	148
149	149	149	149	149	149	149	149
150	150	150	150	150	150	150	150



LEGENDA

ATERRO

CORTES



PREFEITURA MUNICIPAL DE GUAMARINHA DO NORTE

RECUPERAÇÃO DE ESTRADAS VICINAS AO MUNICÍPIO DE GUAMARINHA

LOT. NORTE-DE - 17 - 08872/03

SEÇÕES TRANSVERSAIS



PREFEITURA MUNICIPAL DE GUARACIMES DO NORTE
REGISTRAÇÃO DE ESTRAÇAS VULNERAIS NO MUNICÍPIO DE GUARACIMES DO NORTE - PI
SEÇÃO TRANSVERSAIS



JJA BARROS & FILHOS
RUA ... Nº ...
Cidade ...

LEGENDA
..... ATERRIS
..... CORRÊ

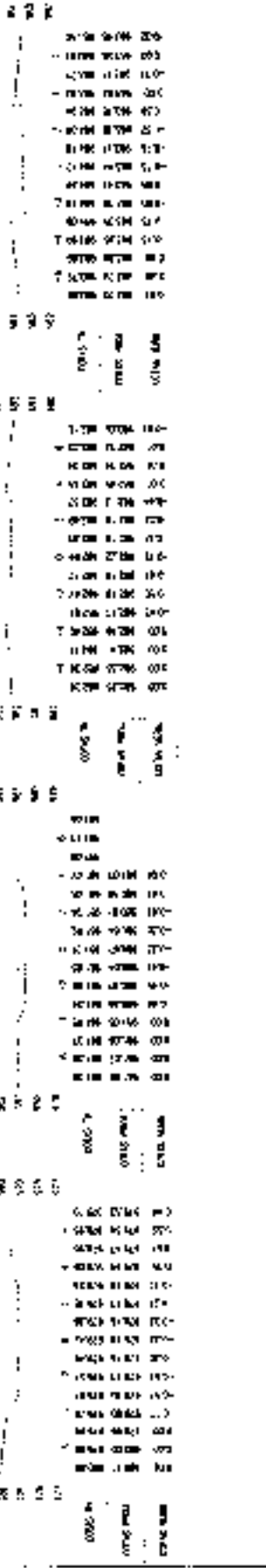
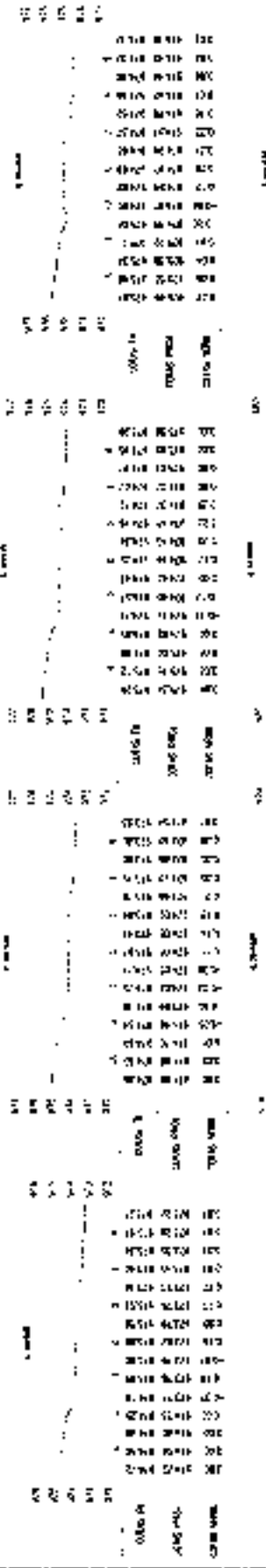
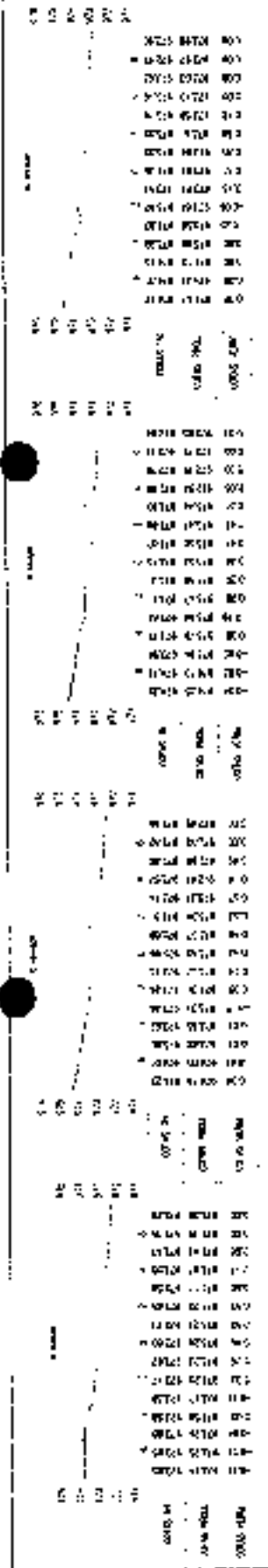

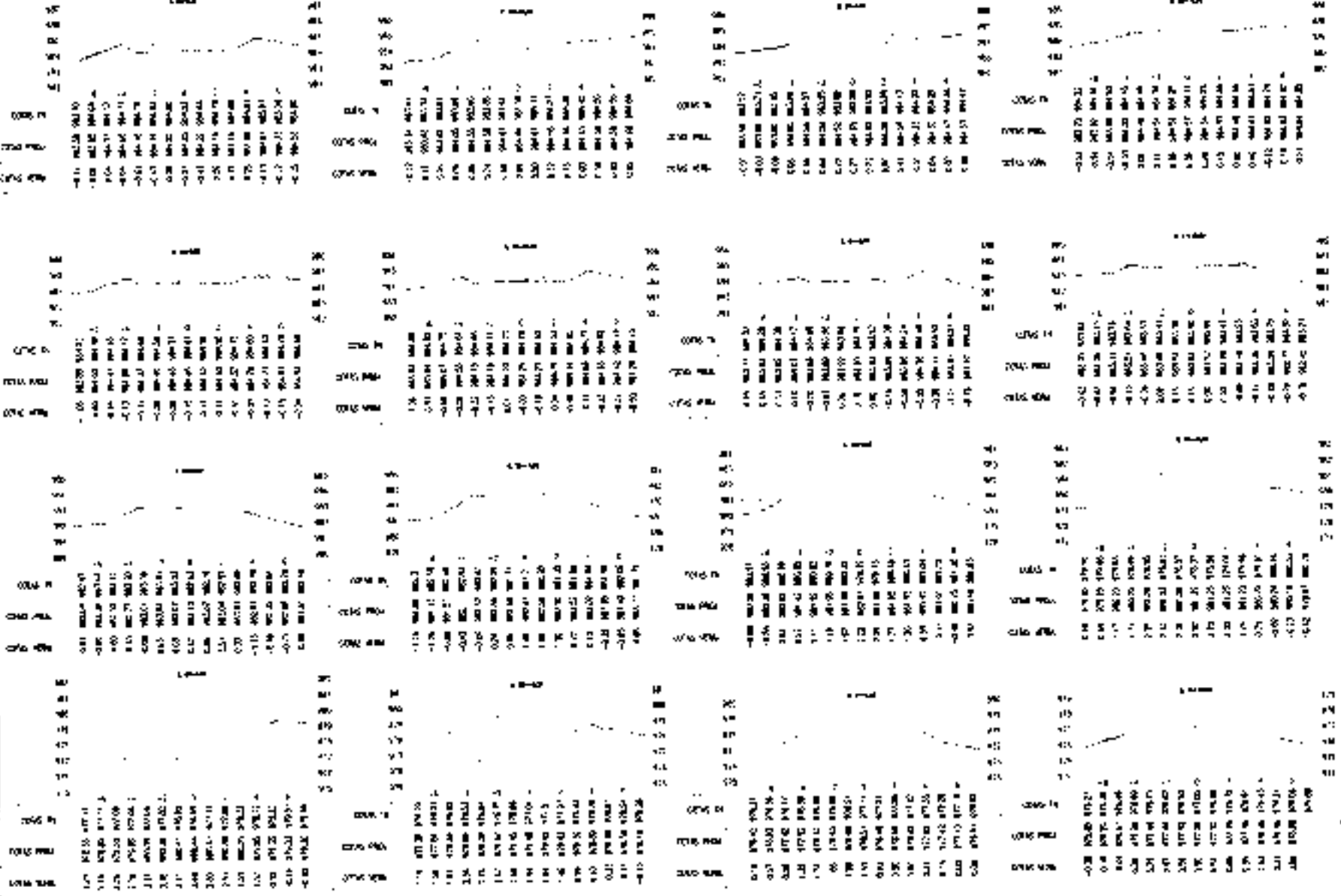

LEGENDA

ATERRO

CORTES



PREFEITURA MUNICIPAL DE GUARACIABA DO NORTE

RECUPERAÇÃO DE ESTRADAS VICINAIS NO MUNICÍPIO DE GUARACIABA DO NORTE-CE - PT 1082700-01

SEÇÕES TRANSVERSAIS

PROJETO: PAVIMENTAÇÃO DE ESTRADAS VICINAIS

PROJETO: PAVIMENTAÇÃO DE ESTRADAS VICINAIS

7/15
11250





LEGENDA

ATERRO
 CORTE

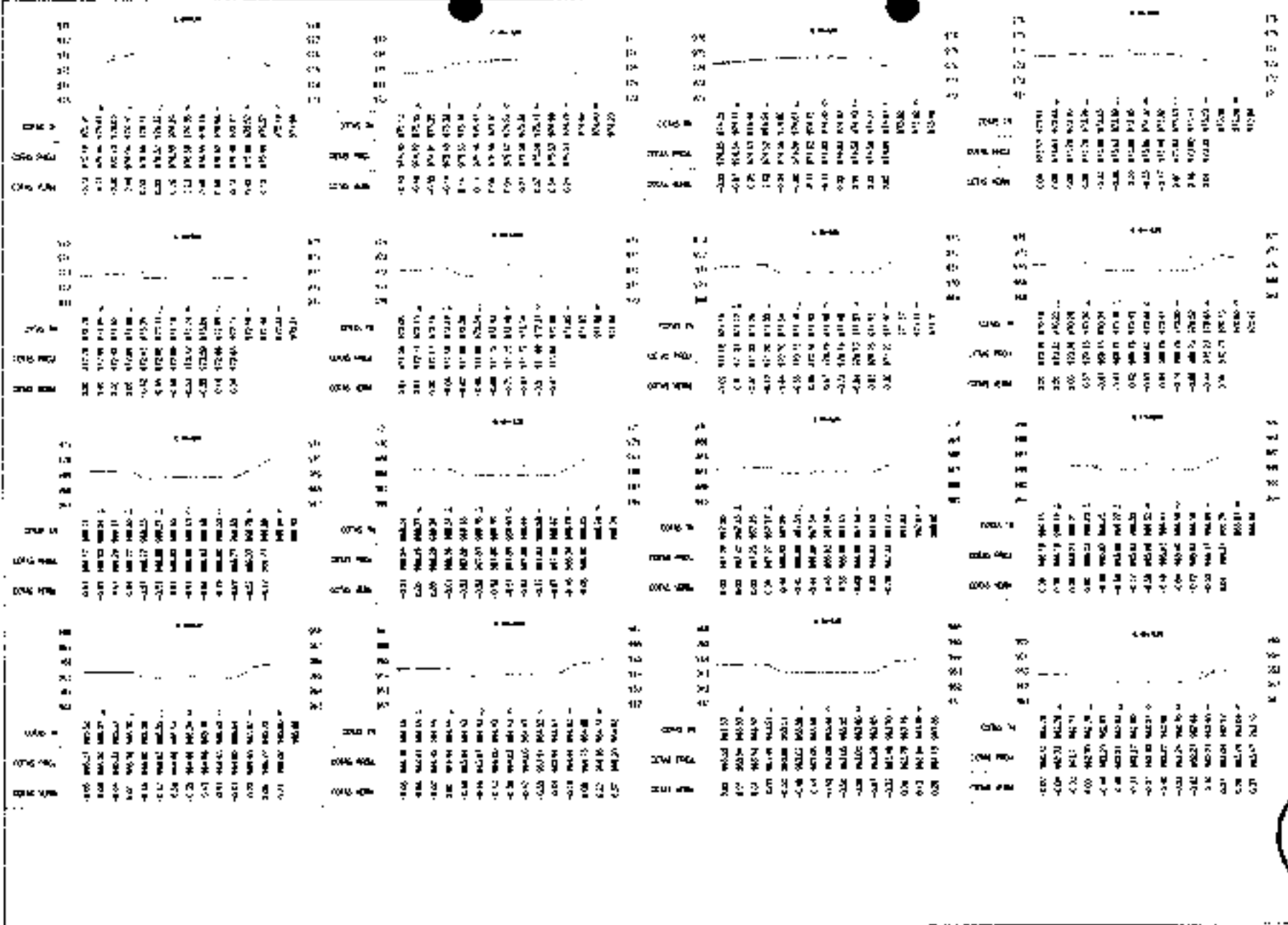

 J.B. ENGENHARIA E PROJETOS	PREFEITURA MUNICIPAL DE GUARACIARA DO NORTE		PLANIMETRIA
	RECUPERAÇÃO DE ESTRADAS VICINAIS NO MUNICÍPIO DE GUARACIARA DO NORTE - CE - PT 1086270-05		8 / 15
SEÇÕES TRANSVERSAIS		DATA:	
PROJETO:		ESCALA:	
EXECUÇÃO:		DATA:	



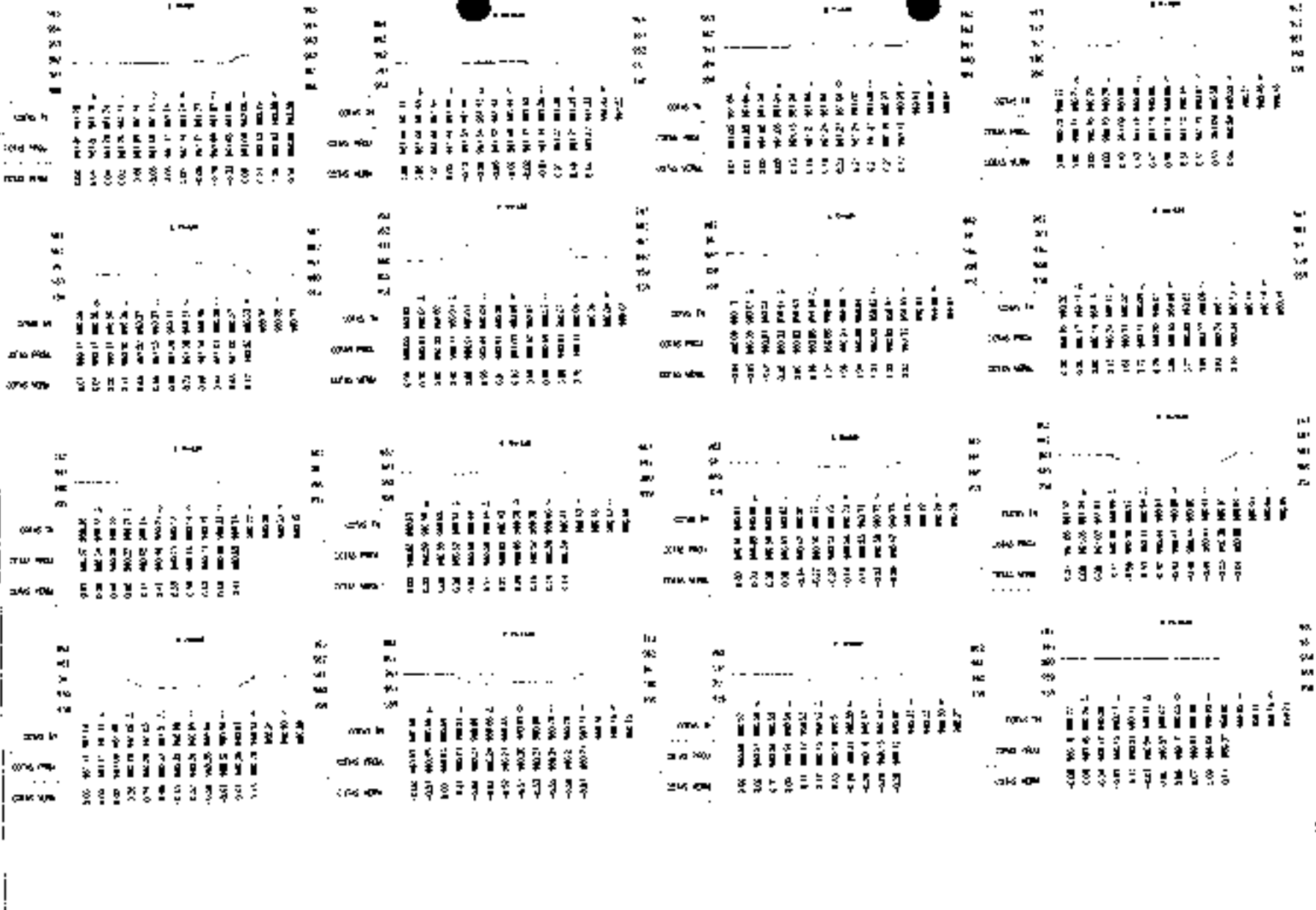

PREFEITURA MUNICIPAL DE GUARACIAMA DO NORTE
 RECOUPERAÇÃO DE ESTRADAS VICINAIS NO MUNICÍPIO DE GUARACIAMA DO NORTE-CE - PT 106677003
 BLOCOS TRANSVERSAIS

9 / 15
 1200



LEGENDA
 [] ATERRO
 [] CORTE

LEGENDA

-  ATERRU
-  CORTE

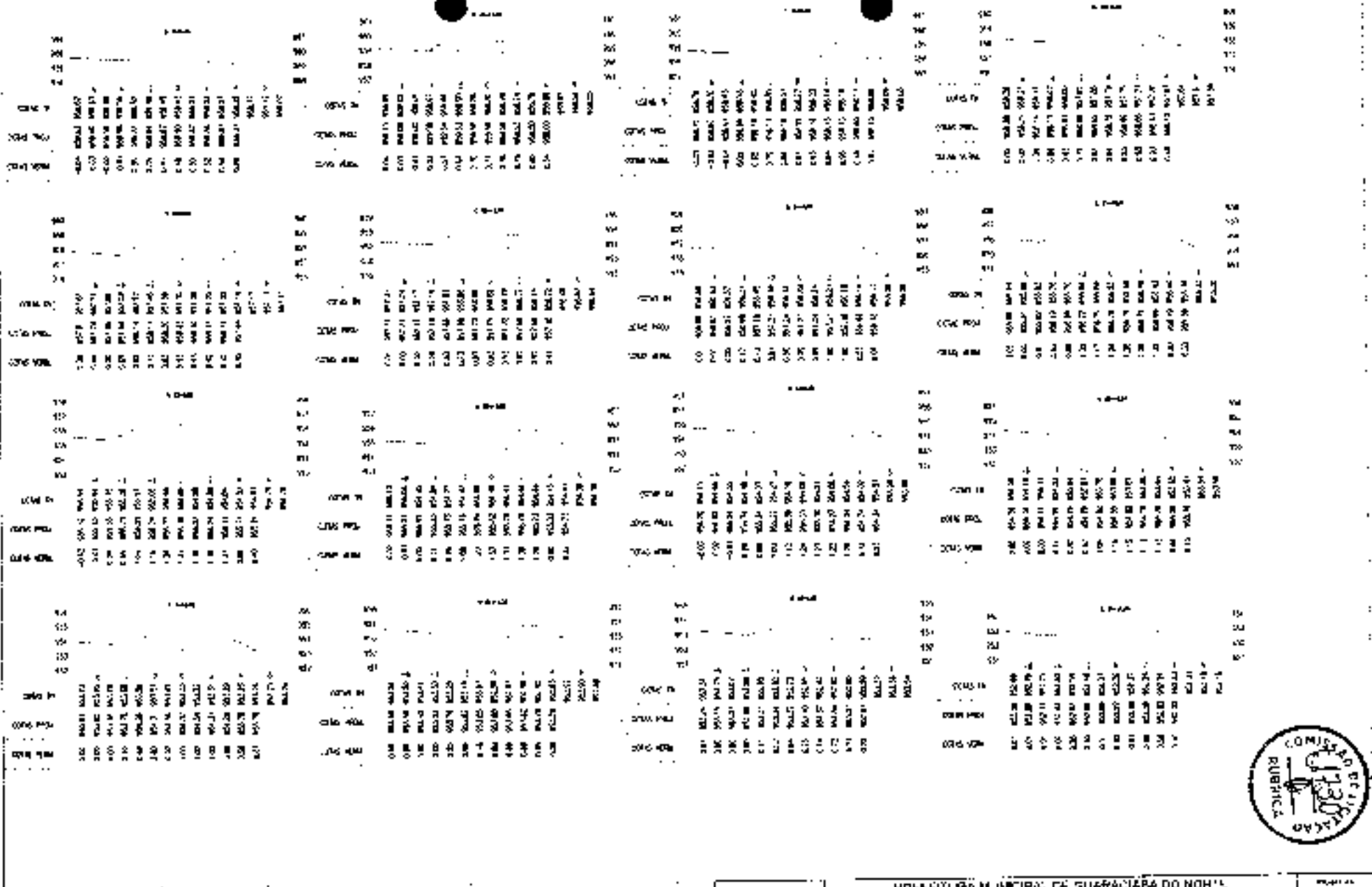



JOTA BARROS
PROFESSOR

PREFEITURA MUNICIPAL DE GUARACIABA DO NORTE

REGISTRAÇÃO DE ESTRADAS VICINAIS NO MUNICÍPIO DE GUARACIABA DO NORTE-CE - Fº 1086700-01

SEÇÕES TRANSVERSAIS

PROJETO

10 / 15

FECHA

1/2017



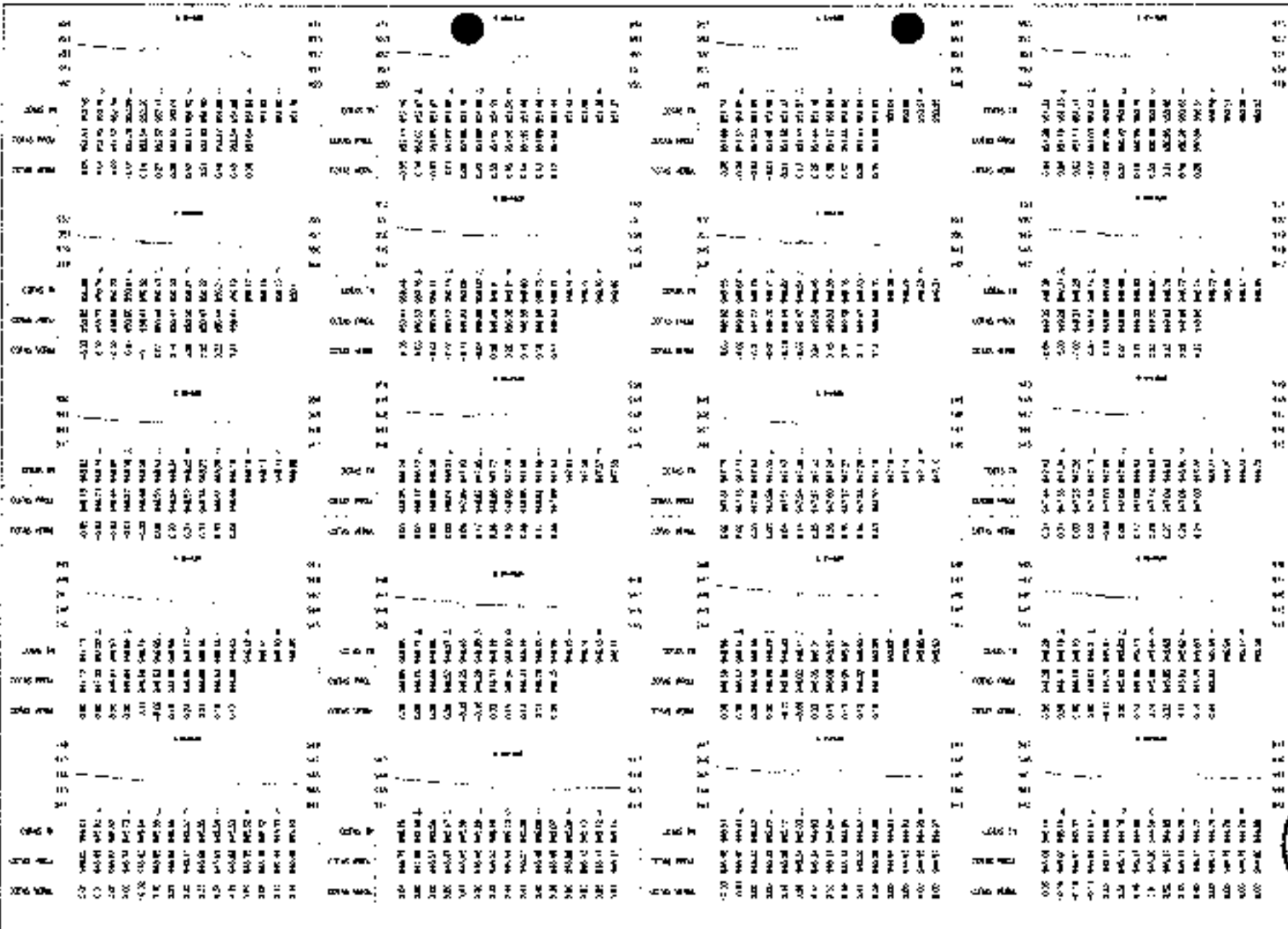

LEGENDA

ATERRO
 CORTE



PREFEITURA MUNICIPAL DE GUARACABA DO NORTE

RECOLPERAÇÃO DE ESTRADAS VEINAIS NO MUNICÍPIO DE GUARACABA DO NORTE - CE - PT 1366270-03

SEÇÕES TRANSVERSAIS

PROJETO: [unreadable]

ESCALA: [unreadable]

PRIMEIRA

11 / 15

1/200

LEGENDA

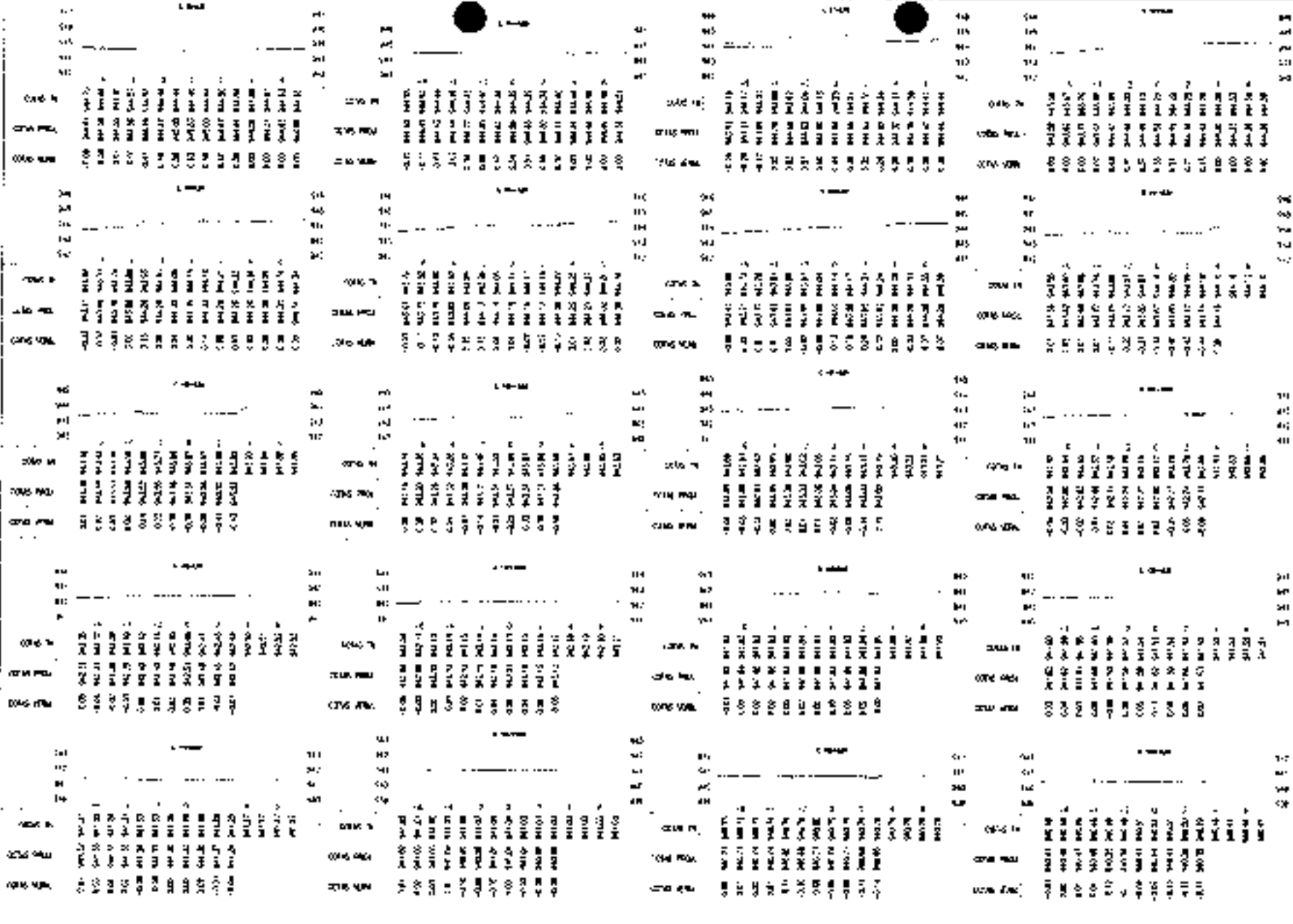
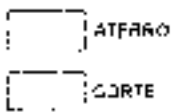

PREFEITURA MUNICIPAL DE GUARACIABA DO NORTE
 RECUPERAÇÃO DE ESTRADAS VICINAIS NO MUNICÍPIO DE GUARACIABA
 DO NORTE-CE - PT 1/8002 (1/10)
 SEÇÕES TRANSVERSAIS

12 / 15
 Escala: 1:500

ANO	VALOR	VALOR	VALOR	VALOR
1997	1.17	4.000	100,00	4.000,00
1998	1.18	4.000	100,00	4.000,00
1999	1.19	4.000	100,00	4.000,00
2000	1.20	4.000	100,00	4.000,00
2001	1.21	4.000	100,00	4.000,00
2002	1.22	4.000	100,00	4.000,00
2003	1.23	4.000	100,00	4.000,00
2004	1.24	4.000	100,00	4.000,00
2005	1.25	4.000	100,00	4.000,00
2006	1.26	4.000	100,00	4.000,00
2007	1.27	4.000	100,00	4.000,00
2008	1.28	4.000	100,00	4.000,00
2009	1.29	4.000	100,00	4.000,00
2010	1.30	4.000	100,00	4.000,00
2011	1.31	4.000	100,00	4.000,00
2012	1.32	4.000	100,00	4.000,00
2013	1.33	4.000	100,00	4.000,00
2014	1.34	4.000	100,00	4.000,00
2015	1.35	4.000	100,00	4.000,00
2016	1.36	4.000	100,00	4.000,00
2017	1.37	4.000	100,00	4.000,00
2018	1.38	4.000	100,00	4.000,00
2019	1.39	4.000	100,00	4.000,00
2020	1.40	4.000	100,00	4.000,00
2021	1.41	4.000	100,00	4.000,00
2022	1.42	4.000	100,00	4.000,00
2023	1.43	4.000	100,00	4.000,00
2024	1.44	4.000	100,00	4.000,00
2025	1.45	4.000	100,00	4.000,00
2026	1.46	4.000	100,00	4.000,00
2027	1.47	4.000	100,00	4.000,00
2028	1.48	4.000	100,00	4.000,00
2029	1.49	4.000	100,00	4.000,00
2030	1.50	4.000	100,00	4.000,00

ANO	VALOR	VALOR	VALOR	VALOR
1997	1.51	4.000	100,00	4.000,00
1998	1.52	4.000	100,00	4.000,00
1999	1.53	4.000	100,00	4.000,00
2000	1.54	4.000	100,00	4.000,00
2001	1.55	4.000	100,00	4.000,00
2002	1.56	4.000	100,00	4.000,00
2003	1.57	4.000	100,00	4.000,00
2004	1.58	4.000	100,00	4.000,00
2005	1.59	4.000	100,00	4.000,00
2006	1.60	4.000	100,00	4.000,00
2007	1.61	4.000	100,00	4.000,00
2008	1.62	4.000	100,00	4.000,00
2009	1.63	4.000	100,00	4.000,00
2010	1.64	4.000	100,00	4.000,00
2011	1.65	4.000	100,00	4.000,00
2012	1.66	4.000	100,00	4.000,00
2013	1.67	4.000	100,00	4.000,00
2014	1.68	4.000	100,00	4.000,00
2015	1.69	4.000	100,00	4.000,00
2016	1.70	4.000	100,00	4.000,00
2017	1.71	4.000	100,00	4.000,00
2018	1.72	4.000	100,00	4.000,00
2019	1.73	4.000	100,00	4.000,00
2020	1.74	4.000	100,00	4.000,00
2021	1.75	4.000	100,00	4.000,00
2022	1.76	4.000	100,00	4.000,00
2023	1.77	4.000	100,00	4.000,00
2024	1.78	4.000	100,00	4.000,00
2025	1.79	4.000	100,00	4.000,00
2026	1.80	4.000	100,00	4.000,00
2027	1.81	4.000	100,00	4.000,00
2028	1.82	4.000	100,00	4.000,00
2029	1.83	4.000	100,00	4.000,00
2030	1.84	4.000	100,00	4.000,00

ANO	VALOR	VALOR	VALOR	VALOR
1997	1.85	4.000	100,00	4.000,00
1998	1.86	4.000	100,00	4.000,00
1999	1.87	4.000	100,00	4.000,00
2000	1.88	4.000	100,00	4.000,00
2001	1.89	4.000	100,00	4.000,00
2002	1.90	4.000	100,00	4.000,00
2003	1.91	4.000	100,00	4.000,00
2004	1.92	4.000	100,00	4.000,00
2005	1.93	4.000	100,00	4.000,00
2006	1.94	4.000	100,00	4.000,00
2007	1.95	4.000	100,00	4.000,00
2008	1.96	4.000	100,00	4.000,00
2009	1.97	4.000	100,00	4.000,00
2010	1.98	4.000	100,00	4.000,00
2011	1.99	4.000	100,00	4.000,00
2012	2.00	4.000	100,00	4.000,00
2013	2.01	4.000	100,00	4.000,00
2014	2.02	4.000	100,00	4.000,00
2015	2.03	4.000	100,00	4.000,00
2016	2.04	4.000	100,00	4.000,00
2017	2.05	4.000	100,00	4.000,00
2018	2.06	4.000	100,00	4.000,00
2019	2.07	4.000	100,00	4.000,00
2020	2.08	4.000	100,00	4.000,00
2021	2.09	4.000	100,00	4.000,00
2022	2.10	4.000	100,00	4.000,00
2023	2.11	4.000	100,00	4.000,00
2024	2.12	4.000	100,00	4.000,00
2025	2.13	4.000	100,00	4.000,00
2026	2.14	4.000	100,00	4.000,00
2027	2.15	4.000	100,00	4.000,00
2028	2.16	4.000	100,00	4.000,00
2029	2.17	4.000	100,00	4.000,00
2030	2.18	4.000	100,00	4.000,00

ANO	VALOR	VALOR	VALOR	VALOR
1997	2.19	4.000	100,00	4.000,00
1998	2.20	4.000	100,00	4.000,00
1999	2.21	4.000	100,00	4.000,00
2000	2.22	4.000	100,00	4.000,00
2001	2.23	4.000	100,00	4.000,00
2002	2.24	4.000	100,00	4.000,00
2003	2.25	4.000	100,00	4.000,00
2004	2.26	4.000	100,00	4.000,00
2005	2.27	4.000	100,00	4.000,00
2006	2.28	4.000	100,00	4.000,00
2007	2.29	4.000	100,00	4.000,00
2008	2.30	4.000	100,00	4.000,00
2009	2.31	4.000	100,00	4.000,00
2010	2.32	4.000	100,00	4.000,00
2011	2.33	4.000	100,00	4.000,00
2012	2.34	4.000	100,00	4.000,00
2013	2.35	4.000	100,00	4.000,00
2014	2.36	4.000	100,00	4.000,00
2015	2.37	4.000	100,00	4.000,00
2016	2.38	4.000	100,00	4.000,00
2017	2.39	4.000	100,00	4.000,00
2018	2.40	4.000	100,00	4.000,00
2019	2.41	4.000	100,00	4.000,00
2020	2.42	4.000	100,00	4.000,00
2021	2.43	4.000	100,00	4.000,00
2022	2.44	4.000	100,00	4.000,00
2023	2.45	4.000	100,00	4.000,00
2024	2.46	4.000	100,00	4.000,00
2025	2.47	4.000	100,00	4.000,00
2026	2.48	4.000	100,00	4.000,00
2027	2.49	4.000	100,00	4.000,00
2028	2.50	4.000	100,00	4.000,00
2029	2.51	4.000	100,00	4.000,00
2030	2.52	4.000	100,00	4.000,00

LEGENDA

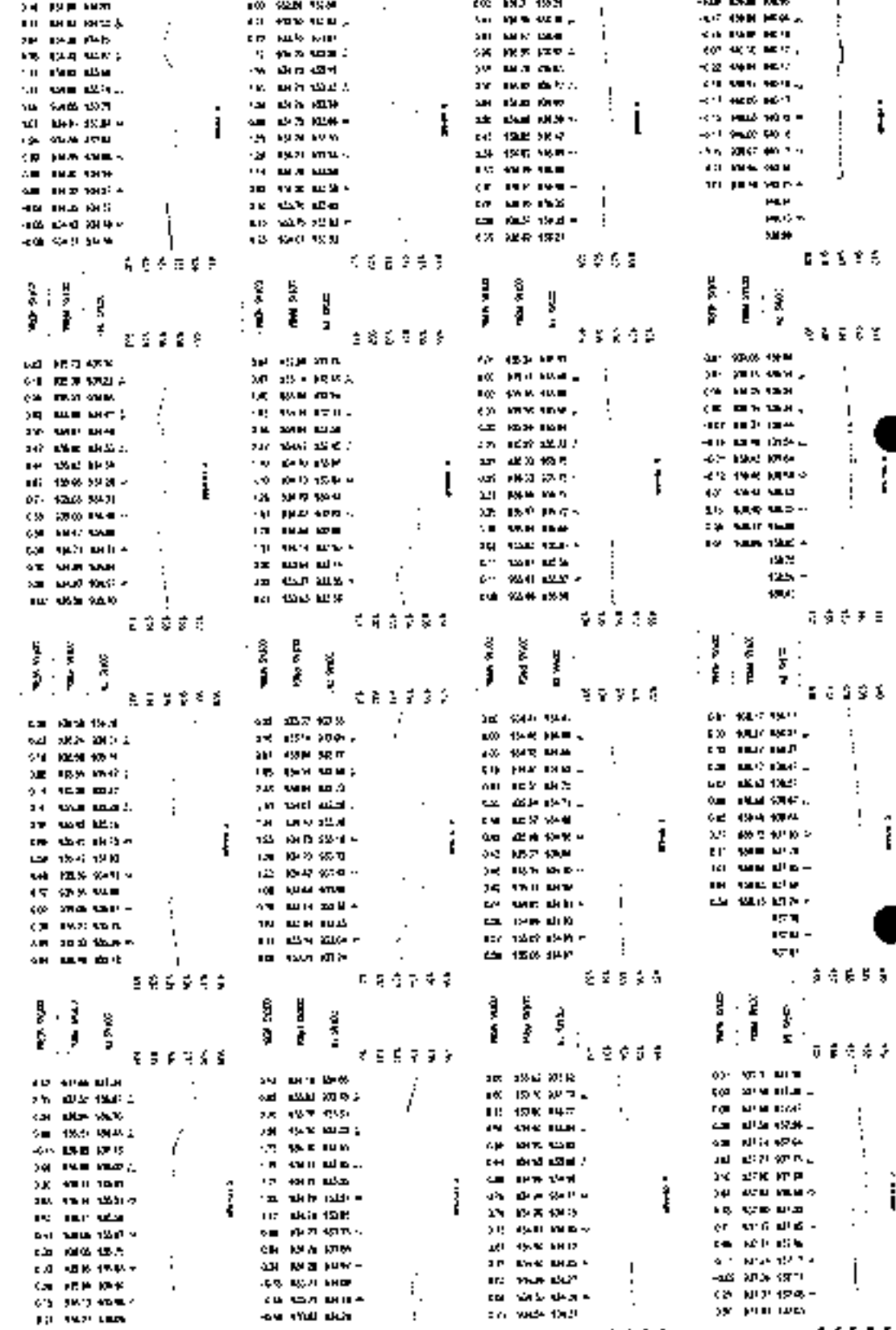
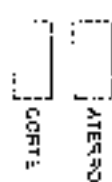

PRESIDENTE MUNICIPAL DE GUARACIABA DO NORTE
 RECUPIRAÇÃO DE ESTADUALS ANIMAIS NO MUNICÍPIO DE GUARACIABA DO NORTE - PE
 DO NORTE - PE - PT 10882703
 SEÇÕES TRANSVERSAIS
 13 / 15
 L. 13.152

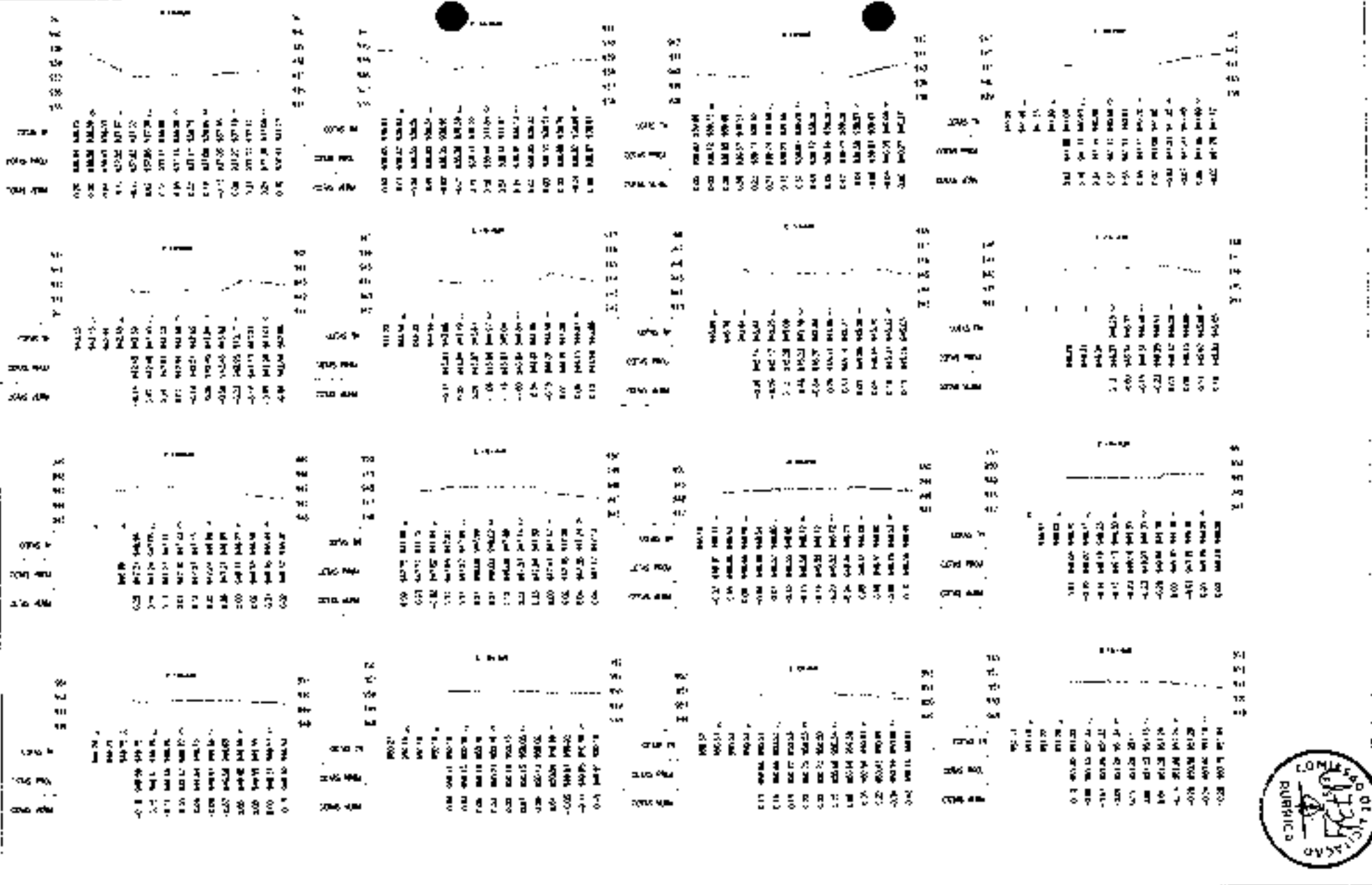

LEGENDA

ATERRO

CORTE



PREFEITURA MUNICIPAL DE GUARACÁ-PAZ (ZONA NORTE)		Folha nº
RECUPERAÇÃO DE ESTRADAS VIZINAIS NO MUNICÍPIO DE GUARACIABA DO NORTE-CE - PT 1396270-03		14 / 15
SEÇÃO TRANSVERSAIS		ESCALA
PROPOSTA	PROJ. CIVIL: ARTELIS RIBEIRO DE ALMEIDA; PROJ. ELETRIC: FERNANDA FERREIRA	1:50
AUTORIZAÇÃO	NOME DO PROJ. EXECUTADO: RECUPERAÇÃO DE ESTRADAS VIZINAIS	



2 10 20 30 40 50 60

70 80 90 100 110 120 130 140

150 160 170 180 190 200 210 220

230 240 250 260 270 280 290 300

310 320 330 340 350 360 370 380

390 400 410 420 430 440 450 460

470 480 490 500 510 520 530 540

550 560 570 580 590 600 610 620

630 640 650 660 670 680 690 700

710 720 730 740 750 760 770 780

790 800 810 820 830 840 850 860

870 880 890 900 910 920 930 940

950 960 970 980 990 1000

LEGENDA

- ATERRÇO
- CONT

 JOYÁ BARROS E FILHOS	PREFEITURA MUNICIPAL DE CLARACIADA DO NORTE	15 / 15
	RECUPERAÇÃO DE ESTRADAS VICINAIS NO MUNICÍPIO DE CLARACIADA DO NORTE-CE - PI 1006270-03	
	SEÇÕES TRANSVERSAIS	
	PROJETO DE: ENG. CIVIL AFONSO ANTÔNIO FERREIRA DE ARAÚJO	ISSUC
LIVRAMENTO: FOMENTO 2014	FOLHA Nº 15 DE 15 - DATA 04/08/2014, 09:35:36	





0 1000 2000

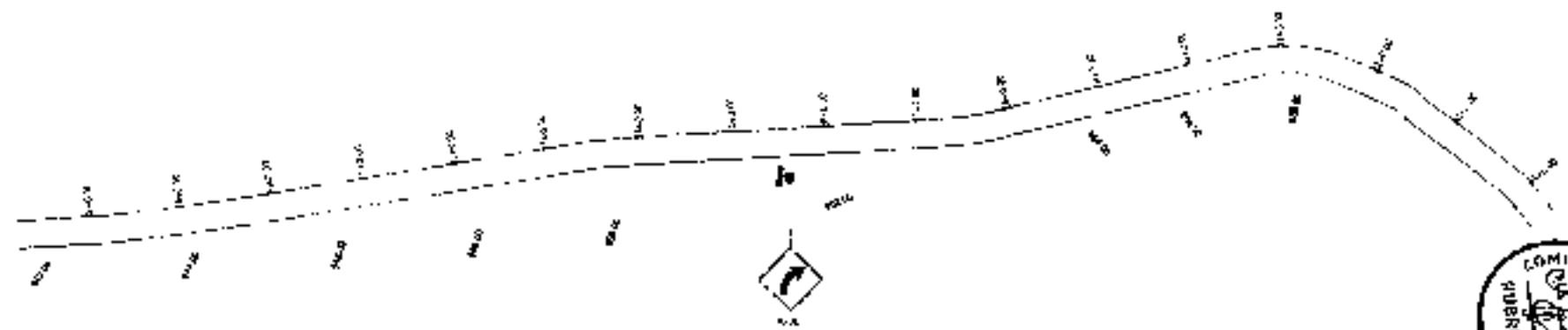

0 1000 2000



	PREFEITURA MUNICIPAL DE GUARACIABA DO NORTE		Folha nº
	RECUPERAÇÃO DE ESTRADAS VICINAIS NO MUNICÍPIO DE GUARACIABA DO NORTE-DE - PT 1085270-03		1 / 05
	SPATIALIZAÇÃO URBANA		DATA
PROJETISTA	JOTA BRAND'S PROJETOS		2017
MUNICÍPIO	GUARACIABA DO NORTE		2017

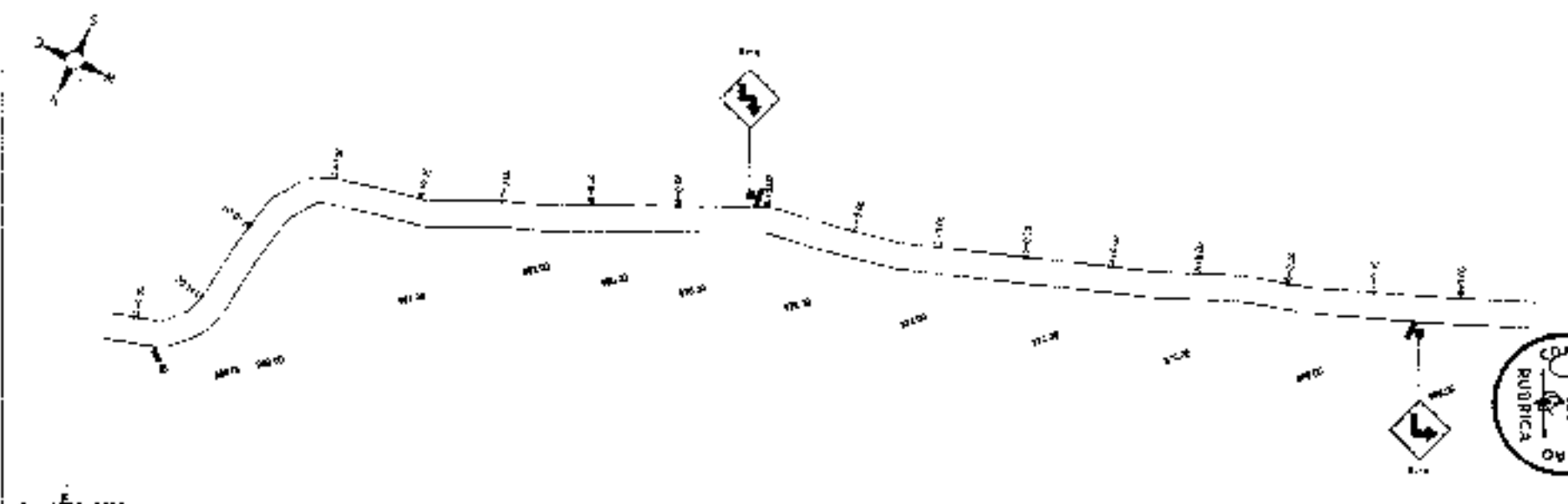
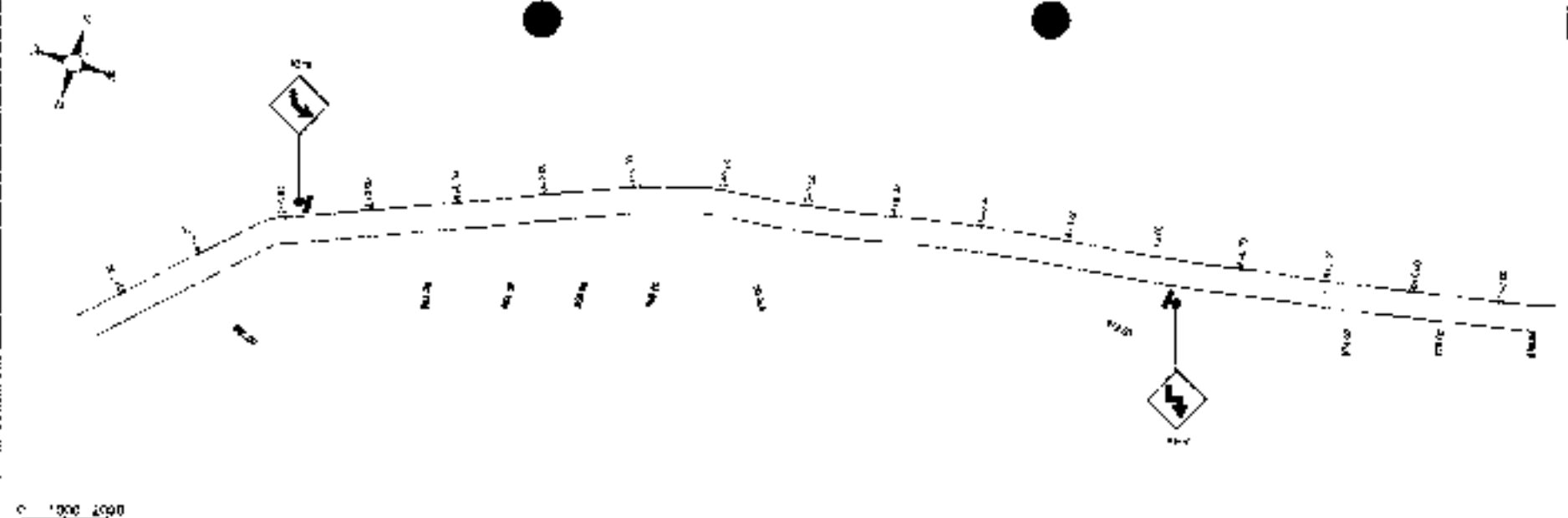

	PREFEITURA MUNICIPAL DE GUARACIARA DO NORTE		Data de
	RECUPERAÇÃO DE ESTRADAS VICINAIS NO MUNICÍPIO DE GUARACIARA DO NORTE-CE - PT 108527003		2 / 05
	SEMAZ - SEMAR - SEMOP - SEMURB - SEMTUR - SEMS - SEMSAB - SEMSIA - SEMSUC - SEMSUS - SEMSANE - SEMSANEAT - SEMSANEAS - SEMSANEAB - SEMSANEAD - SEMSANEAE - SEMSANEAF - SEMSANEAG - SEMSANEAJ - SEMSANEAK - SEMSANEAL - SEMSANEAM - SEMSANEAN - SEMSANEAO - SEMSANEAP - SEMSANEAQ - SEMSANEAR - SEMSANEAS - SEMSANEAT - SEMSANEAU - SEMSANEAV - SEMSANEAW - SEMSANEAX - SEMSANEAY - SEMSANEAZ		Folha nº
10.ª ANÁLISE Nº 3318782		11/008	

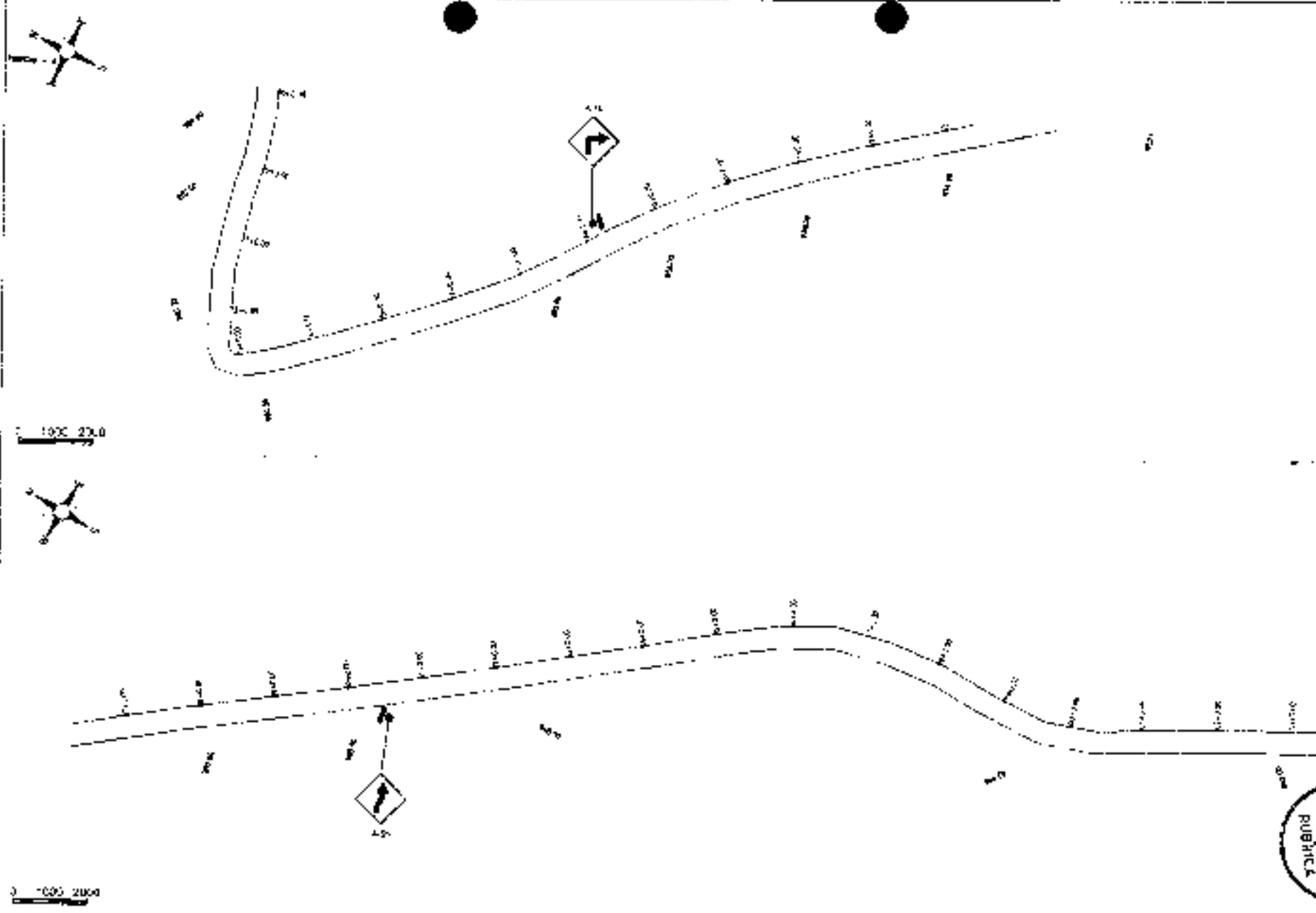

	PREFEITURA MUNICIPAL DE GUARACIABA DO NORTE		Nº 001/2022
	RECUPERAÇÃO DE ESTRADAS VICINAIS NO MUNICÍPIO DE GUARACIABA DO NORTE - CE - PT 1066270-03		3 / 06
	SINALIZAÇÃO VIÁRIA		1/1226
PROPOSTA:	D.O.C. DE SINALIZAÇÃO VIÁRIA PARA O PROJETO		
MODAL:	VERBAIS: RSC, ESCRITAS E FOTOCOPIAS DE PLANOS EM CAD		

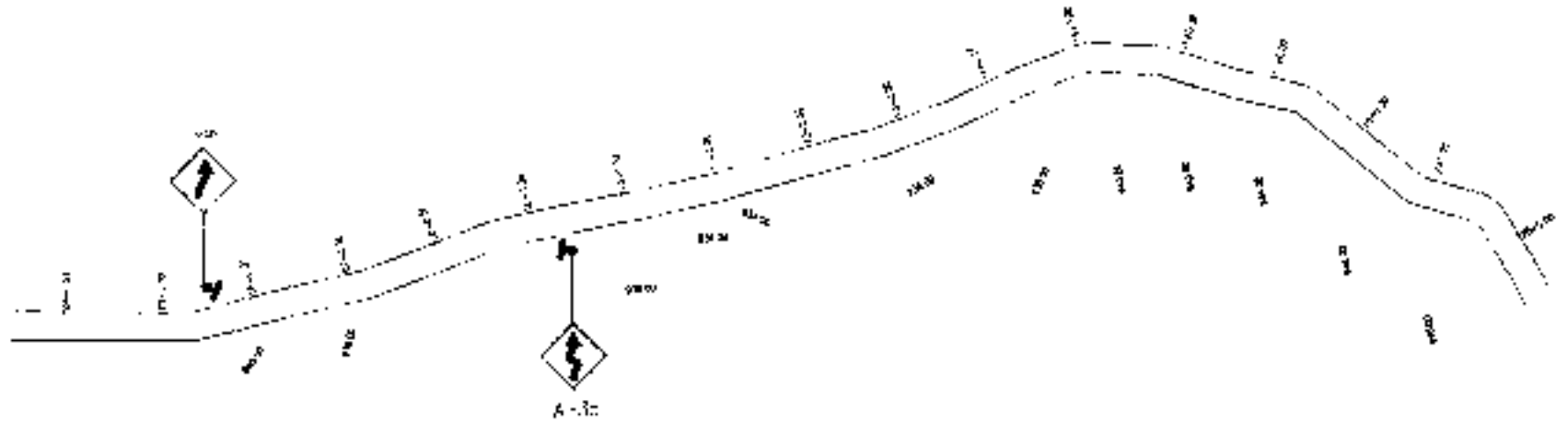

1:000 2000

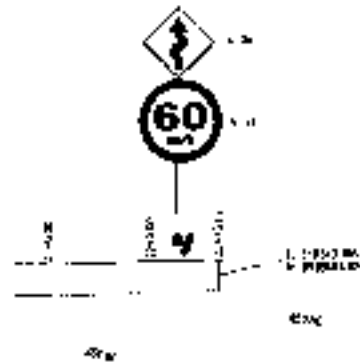

1:000 2000

	PREFEITURA MUNICIPAL DE GUARACARÁ DO NORTE		NUM. 4 / 05
	CONFERÊNCIA DE ESTRADAS VICINAIS NO MUNICÍPIO DE GUARACARÁ DO NORTE-CE - PT 1096270-03		DATA 11/05
	SINALIZAÇÃO VIÁRIA		1:1000
	PROJETA	DEL. CARLOS ALBERTO MORENO FERREIRA - CREA 15189/CE	
APROVA	LUIZ CARLOS DE MOURA LOPES - CREA 15189/CE		

Regulamento Transversal

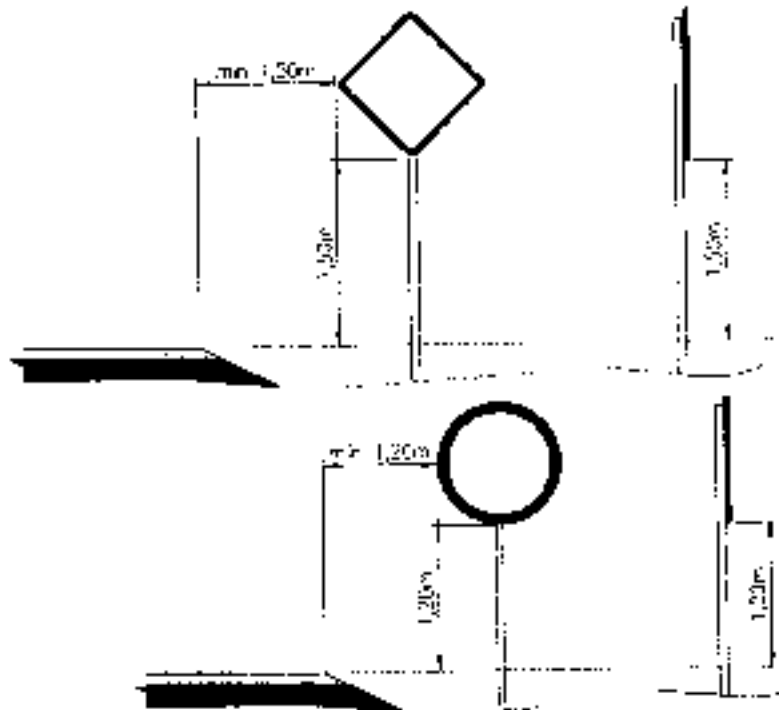

PLACAS DE AVERTÊNCIA

PLACAS	CÓDIGO	ENCOMENDAS (cm)	ALÇAMENTO (cm)
	001	200x200	1,50
	002	200x200	1,50
	003	200x200	1,50
	004	200x200	1,50
	005	200x200	1,50
	006	200x200	1,50
	007	200x200	1,50
	008	200x200	1,50
	009	200x200	1,50

PLACAS DE AVERTÊNCIA

PLACAS	CÓDIGO	ENCOMENDAS (cm)	ALÇAMENTO (cm)
	010	200x200	1,50

As placas de sinalização devem ser instaladas de acordo com as seguintes normas:

Norma: NBR 13201 - Sinalização de trânsito

Norma: NBR 13202 - Sinalização de trânsito

Norma: NBR 13203 - Sinalização de trânsito

Norma: NBR 13204 - Sinalização de trânsito

Norma: NBR 13205 - Sinalização de trânsito

As Placas de Sinalização devem ser instaladas de acordo com as seguintes normas:

Norma: NBR 13201 - Sinalização de trânsito

Norma: NBR 13202 - Sinalização de trânsito

Norma: NBR 13203 - Sinalização de trânsito

Norma: NBR 13204 - Sinalização de trânsito

Norma: NBR 13205 - Sinalização de trânsito



PREFEITURA MUNICIPAL DE GUARACIARA DO NORTE
 RECLAMATION DE ESTRADAS VICINAIS NO MUNICÍPIO DE GUARACIARA DO NORTE - CE - PT - 066270-00
 SINALIZAÇÃO VIÁRIA

PLACAS DE SINALIZAÇÃO DE TRÂNSITO - SINALIZAÇÃO DE TRÂNSITO - SINALIZAÇÃO DE TRÂNSITO

PLACAS DE SINALIZAÇÃO DE TRÂNSITO - SINALIZAÇÃO DE TRÂNSITO - SINALIZAÇÃO DE TRÂNSITO

5 / 05
 SEM E.C.

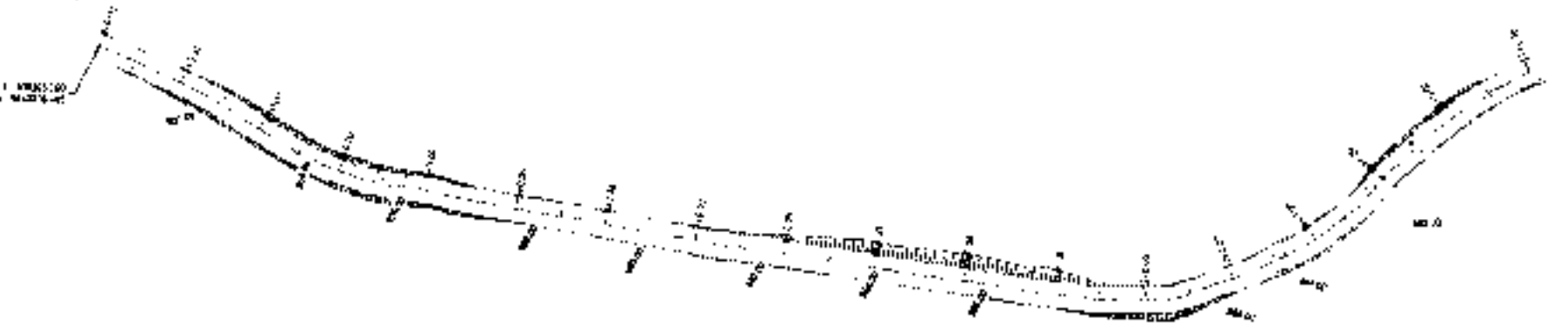

0 1000 2000

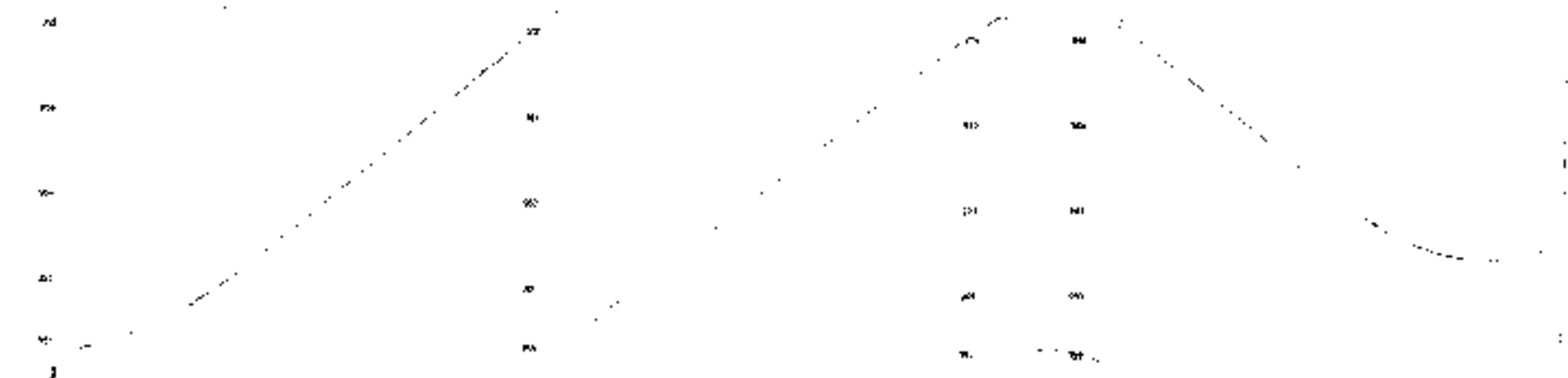

TUBULAGEM	ARREBANCOS	LIMPA	FOFO	TUBO	MURTO	CAY	CANTO DE VIRA



PREFEITURA MUNICIPAL DE GUARACIABA DO NORTE
 RECLPERAÇÃO DE ESTRADAS VICINAIS NO MUNICÍPIO DE GUARACIABA DO NORTE-CE (R.º 1085770-0)
ESTAQUEAMENTO E PERFIL LONGITUDINAL

PROJETO: []
 EXECUÇÃO: []



1 / 03
 DATA: 15/03/2011
 LOCAL: []

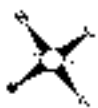

0 1000 2000

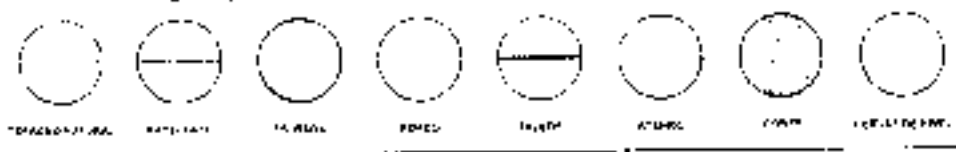
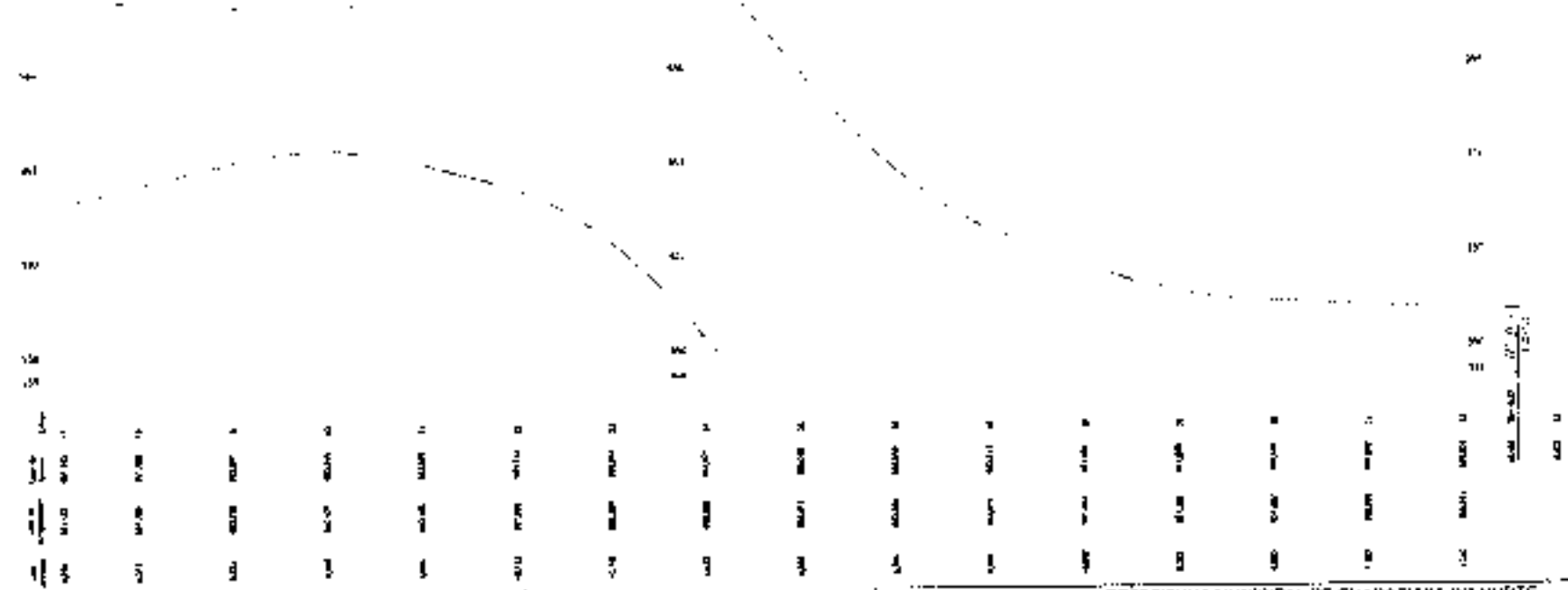

PREFEITURA MUNICIPAL DE GUARACIABA DO NORTE
RECUPERAÇÃO DE ESTRADAS MUNICIPAIS NO MUNICÍPIO DE GUARACIABA DO NORTE - CE - PT 1006270-02
ESTACQUEAMENTO E PERFIL LONGITUDINAL

PROJETA	ENG. CARLOS WILSON MOURA JUNIOR - CREA 1006270-02
SCALE	1:2000 (PLAN) 1:200 (PROFILE)



2 / 03
FOLHA Nº 03
DE 03

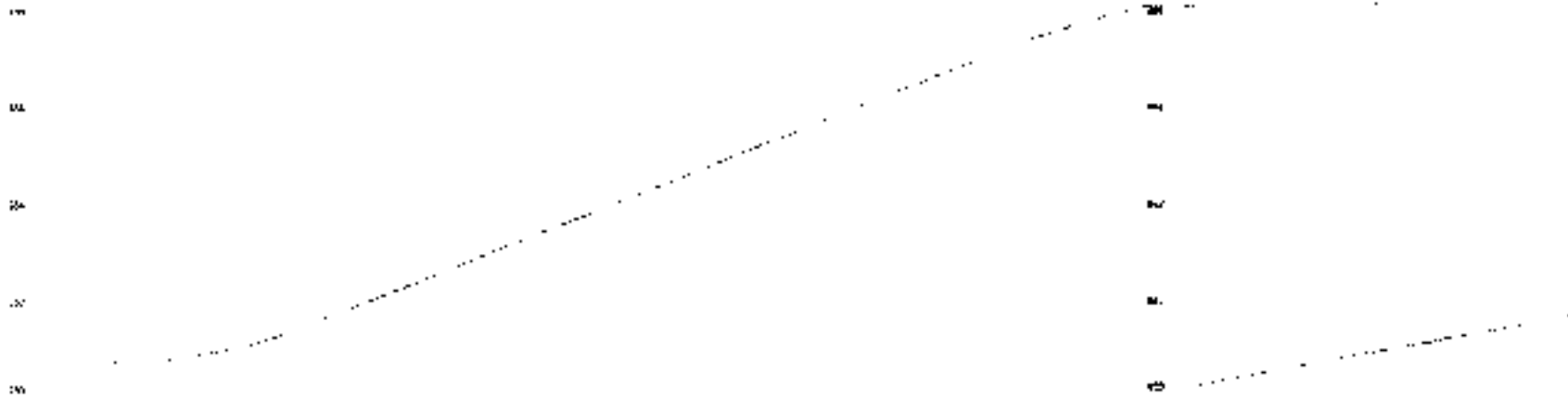
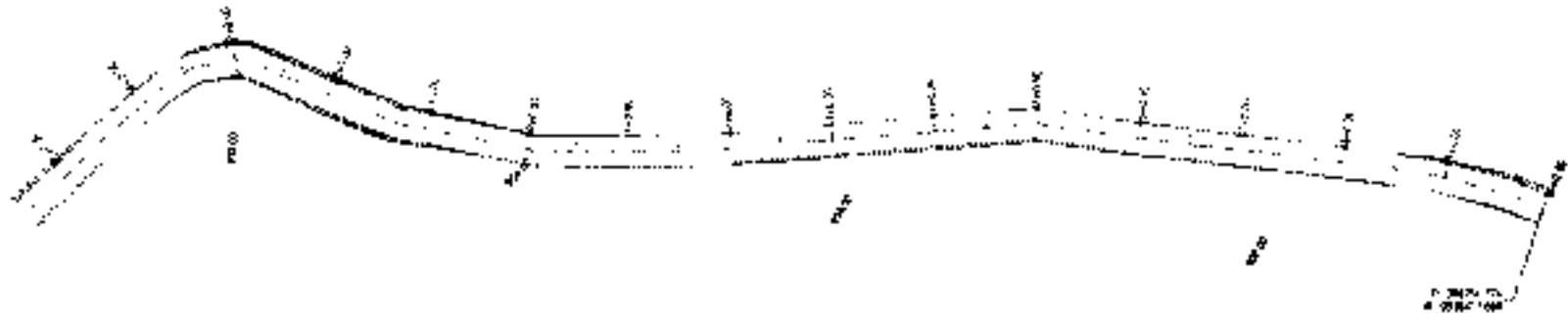
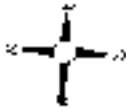

1	2	3	4	5	6	7	8	9	10	11	12	13	14	15	16	17	18	19	20	21	22	23	24	25	26	27	28	29	30	31	32	33	34	35	36	37	38	39	40	41	42	43	44	45	46	47	48	49	50	51	52	53	54	55	56	57	58	59	60	61	62	63	64	65	66	67	68	69	70	71	72	73	74	75	76	77	78	79	80	81	82	83	84	85	86	87	88	89	90	91	92	93	94	95	96	97	98	99	100
---	---	---	---	---	---	---	---	---	----	----	----	----	----	----	----	----	----	----	----	----	----	----	----	----	----	----	----	----	----	----	----	----	----	----	----	----	----	----	----	----	----	----	----	----	----	----	----	----	----	----	----	----	----	----	----	----	----	----	----	----	----	----	----	----	----	----	----	----	----	----	----	----	----	----	----	----	----	----	----	----	----	----	----	----	----	----	----	----	----	----	----	----	----	----	----	----	----	----	-----



PREFEITURA MUNICIPAL DE GUARACABA DO NORTE	
RECUPERAÇÃO DE ESTRADAS RURAIS NO MUNICÍPIO DE GUARACABA DO NORTE - CE - PT 1086270-03	
ESTAQUEAMENTO E PERFIL LONGITUDINAL	
PROJETO	PROJ. CIVIL - ADRIANO DE OLIVEIRA SILVA
ARQUIT.	FRANZ, CARLOS ALBERTO DE MOURA



3 / 03
 17/12/2011



PREFEITURA MUNICIPAL DE GUARACIABA DO NORTE RECUPERAÇÃO DE ESTRADAS VICINAIS NO MUNICÍPIO DE GUARACIABA DO NORTE-CE - PI 1086273-03 BLOCOS TRANSVERSAIS		Nº 1 / 03 1/1030
PROJETO	USO E N.º 1086273-03	
LOCAL	BRAS. 1086273-03	



LEGENDA

	ATERRO
	CORTE

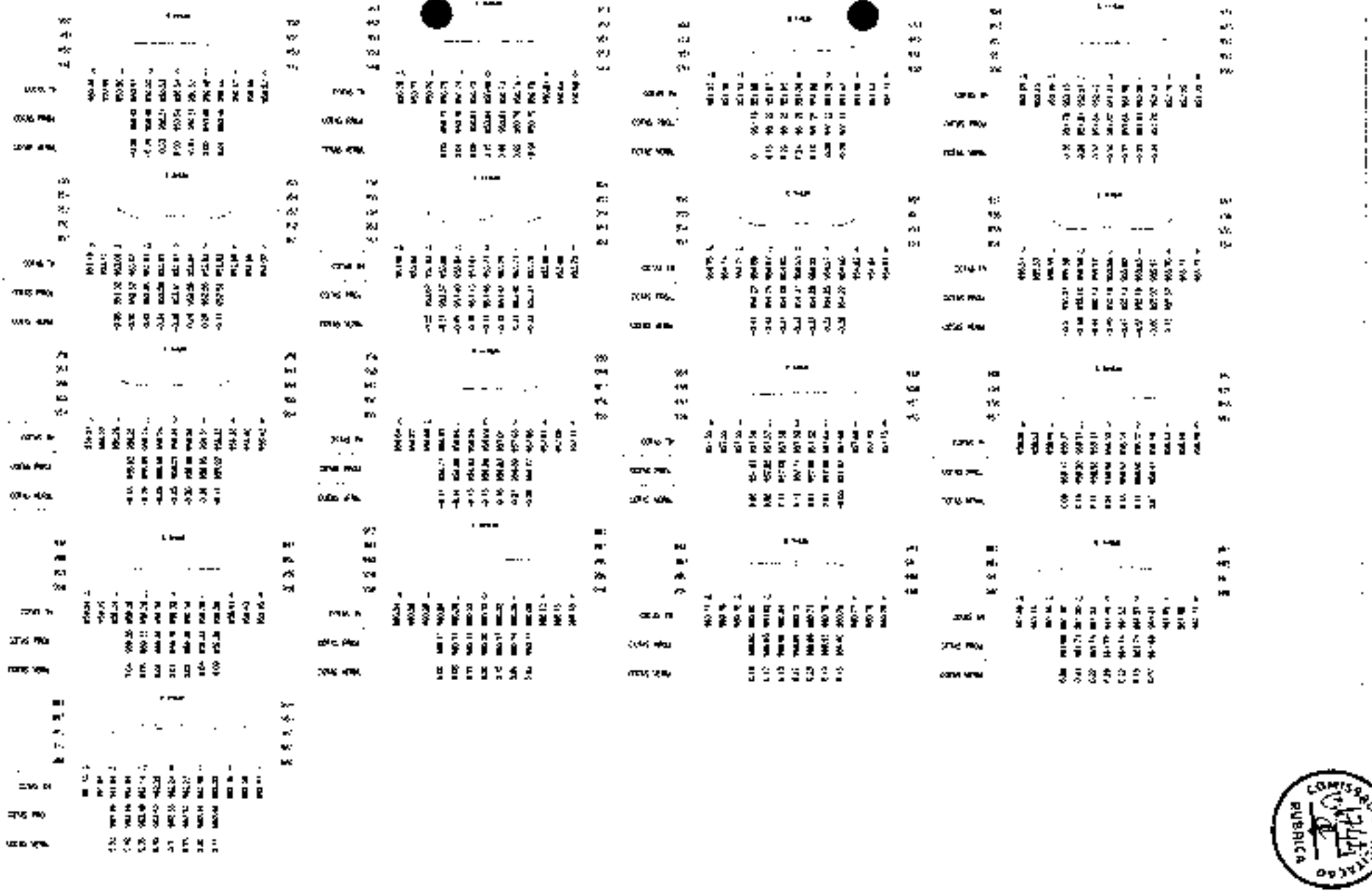





	PREFEITURA MUNICIPAL DE GUARACIABA DO NORTE RECUPERAÇÃO DE ESTRADAS VICINAIS NO MUNICÍPIO DE GUARACIABA DO NORTE - CE - PT 1056270-0-0 SEÇÕES TRANSVERSAIS		2 / 06
	PROJETO DE LICITAÇÃO Nº 001/2014 Nº 001/2014		1/001
	EXECUÇÃO DE OBRAS DE RECONSTRUÇÃO DE ESTRADAS VICINAIS		

LEGENDA

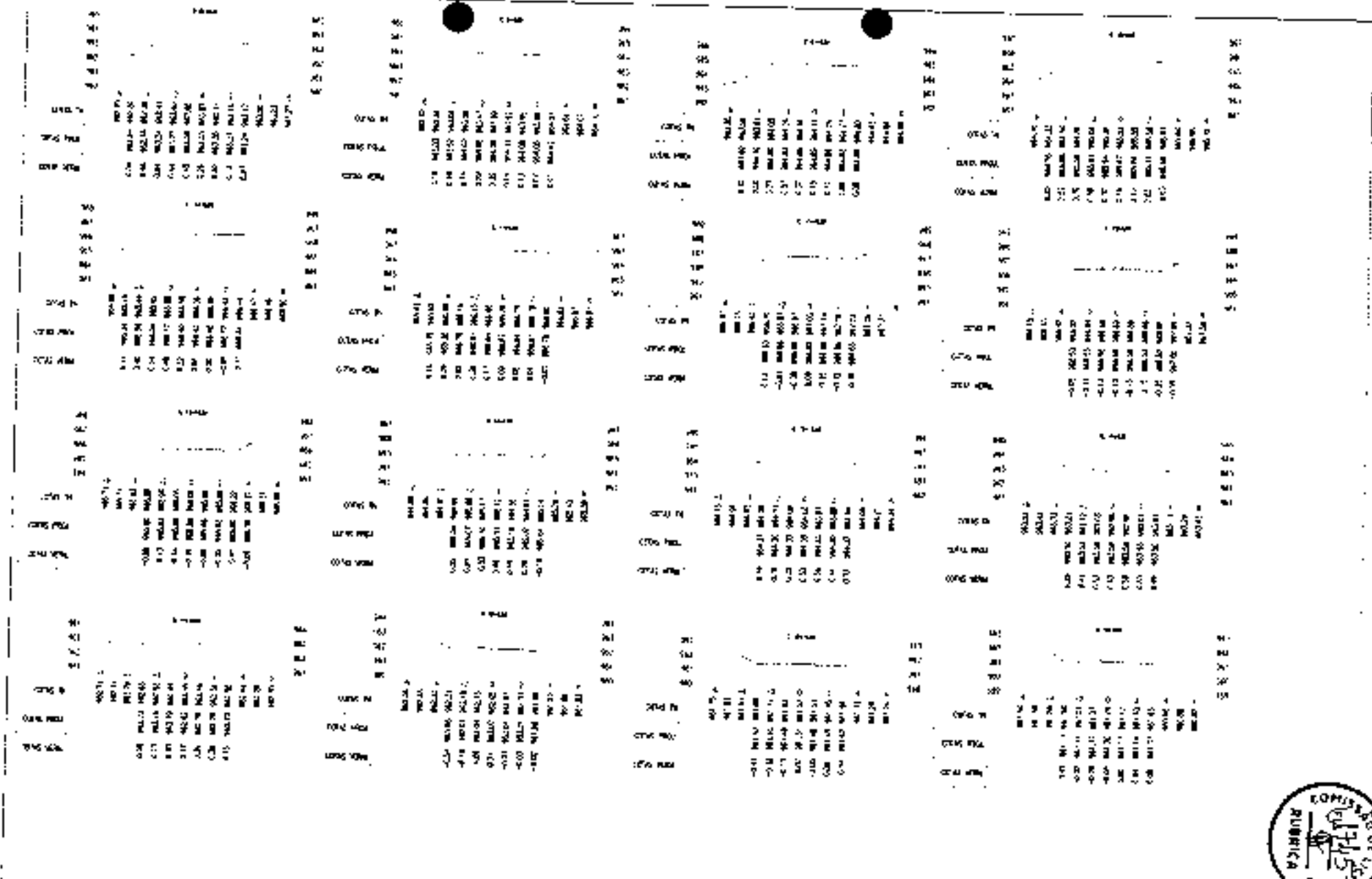
ATERRO
 CORTA





	PREFEITURA MUNICIPAL DE GUARACIABA DO NORTE RECUPERAÇÃO DE ESTRADAS VICINAIS NO MUNICÍPIO DE GUARACIABA DO NORTE-CE - Nº 085270-03 SEÇÕES TRANSVERSAIS		Nº 3 / 06
	ENDEREÇO: RUA CES. FRANKLIN FERREIRA RODRIGUES, 1000 - JARDIM DE SÃO CARLOS - GUARACIABA DO NORTE - CE	Nº 100	DATA: 10/06/2006

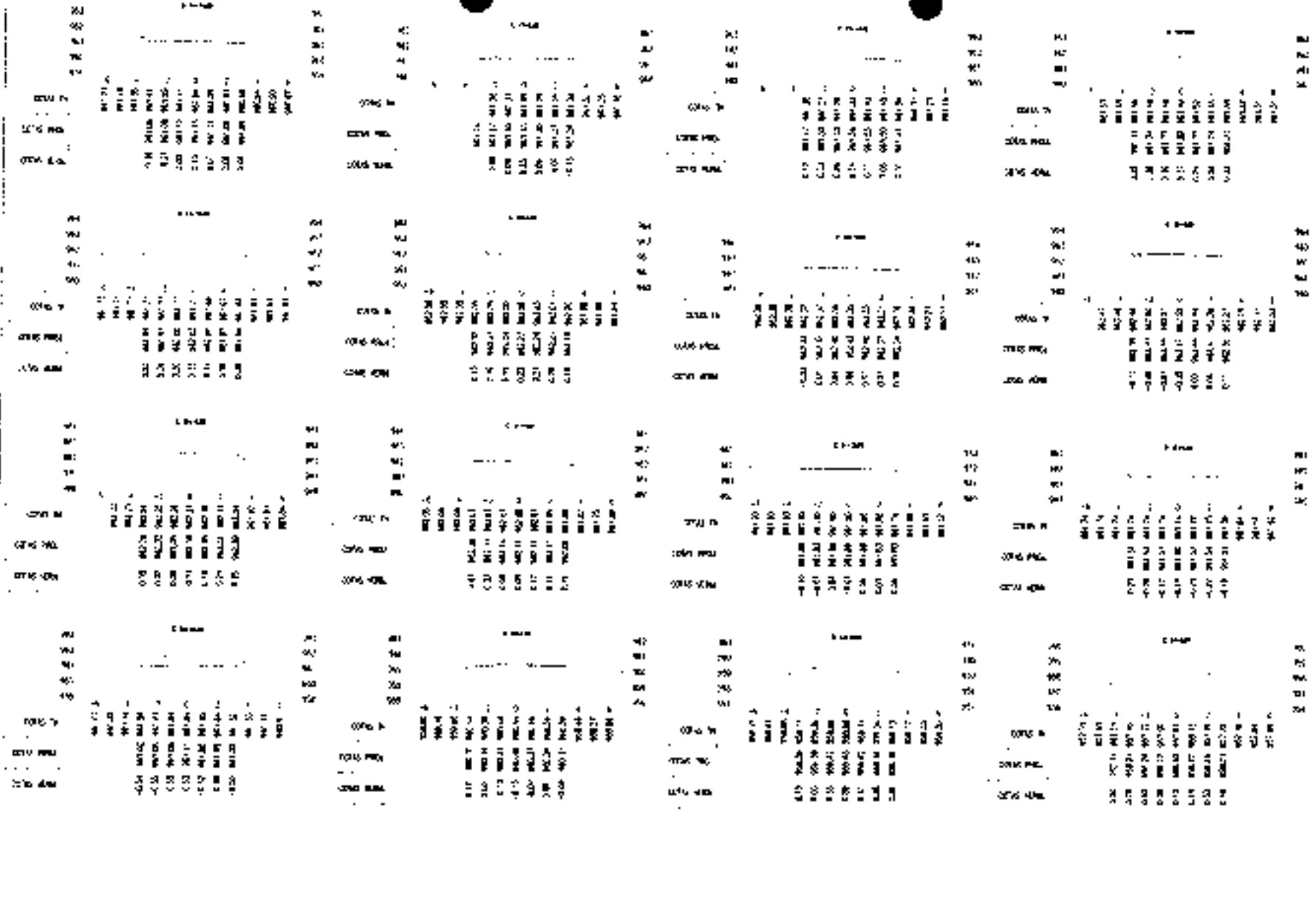

LEGENDA

ATERRRO
 CORTE



PREFEITURA MUNICIPAL DE GUARACIABA DO NORTE
 RECUPERAÇÃO DE ESTRADAS MUNICIPAIS DO MUNICÍPIO DE GUARACIABA DO NORTE (GE - PT 1066270-1)
 SEÇÕES TRANSVERSAIS
 DATA: 14/06/2010
 FOLHA: 4/06

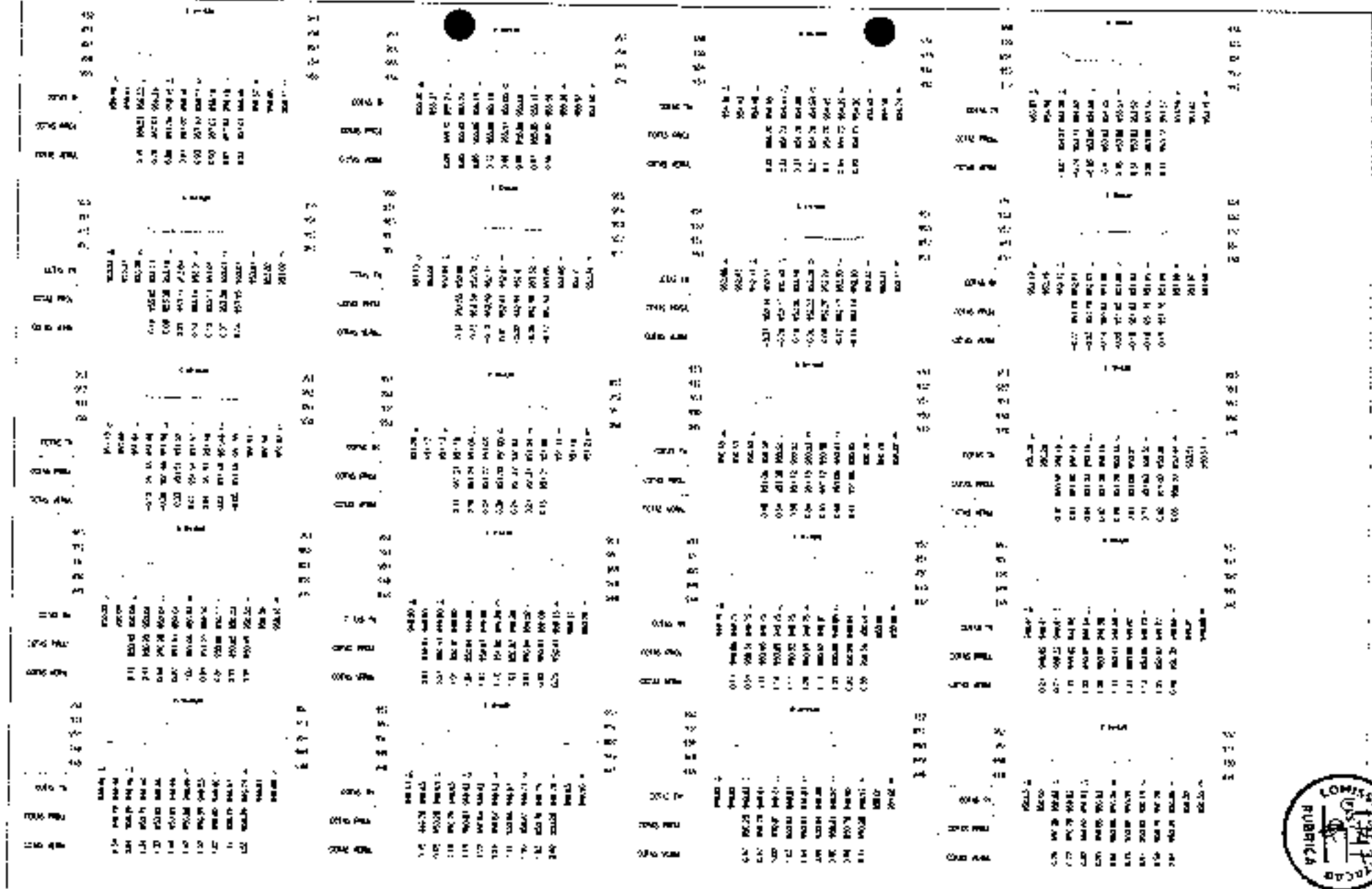

LEGENDA

-  ATERRO
-  CORTE

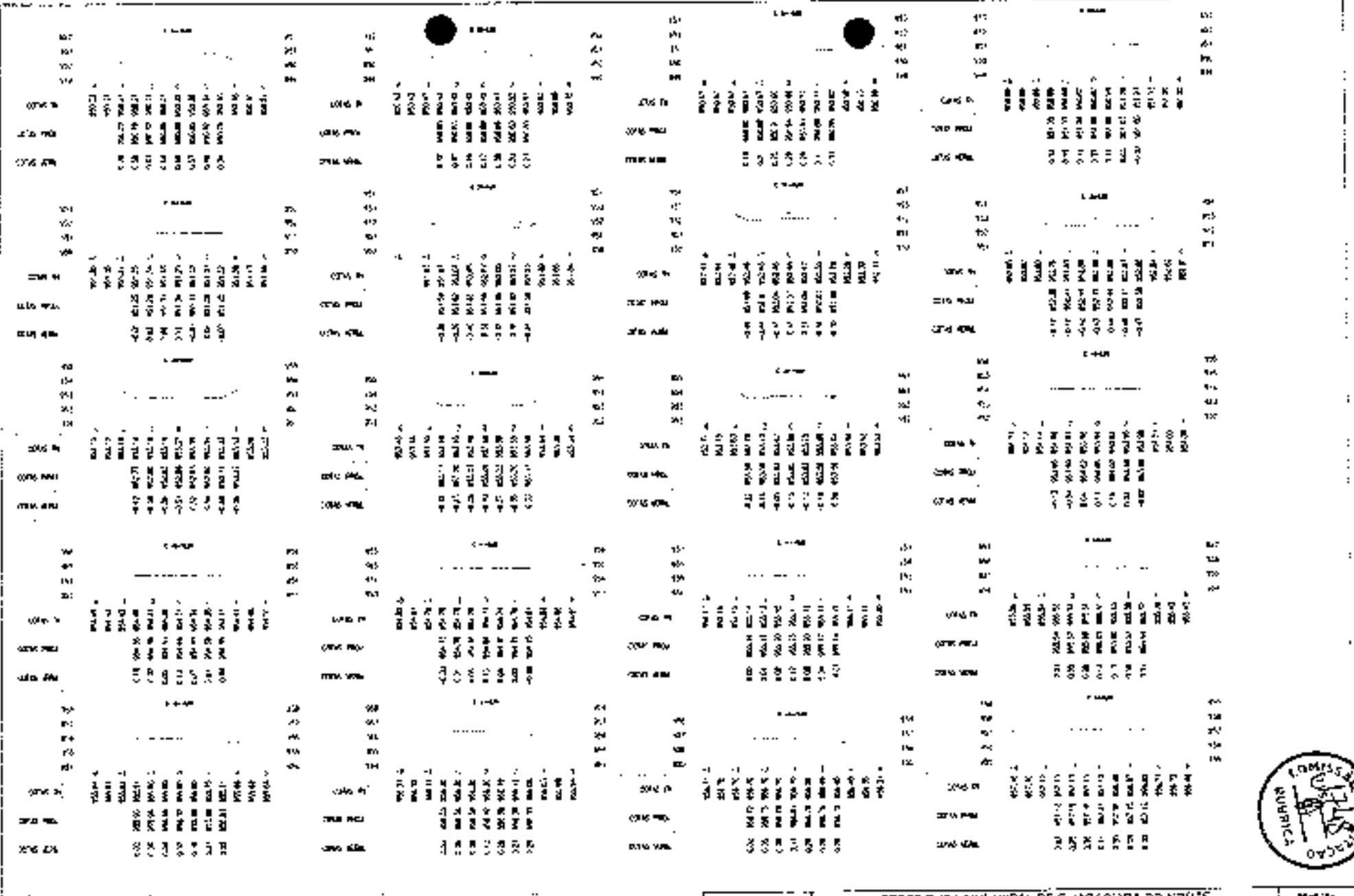

PREFEITURA MUNICIPAL DE GUARAGUAMA DO NORTE
 RECONSTRUÇÃO DE ESTRADAS VICINAIS NO MUNICÍPIO DE GUARAGUAMA DO NORTE-DE-PI (1086270-03)
 SEÇÕES TRANSVERSAIS



5106
 1/2000

LEGENDA

- ATERRO
- CORTE



PREFEITURA MUNICIPAL DE GUARACIABA DO NORTE

RECUPERAÇÃO DE ESTRADAS VICINAIS NO MUNICÍPIO DE GUARACIABA DO NORTE-CE - P1 1008270-03

SEÇÕES TRANSVERSAIS

PROJETO: RECUPERAÇÃO DE ESTRADAS VICINAIS NO MUNICÍPIO DE GUARACIABA DO NORTE-CE - P1 1008270-03

PARCELAMENTO: 4510 - 1008270-03

ESCALA: 1:500

DATA: 06/05

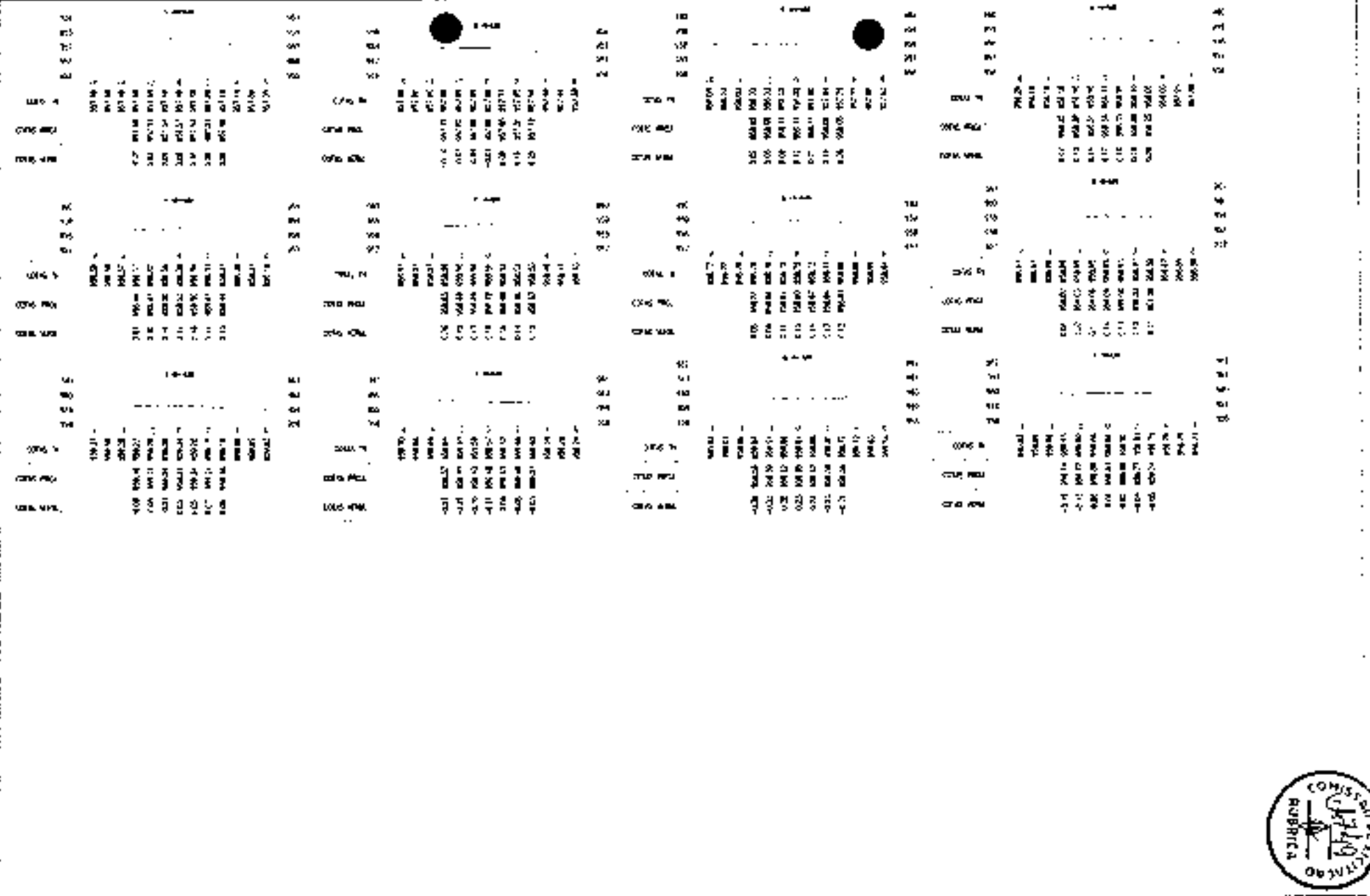

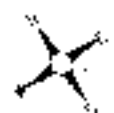

0 1000 2000

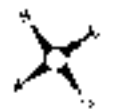

0 1000 2000

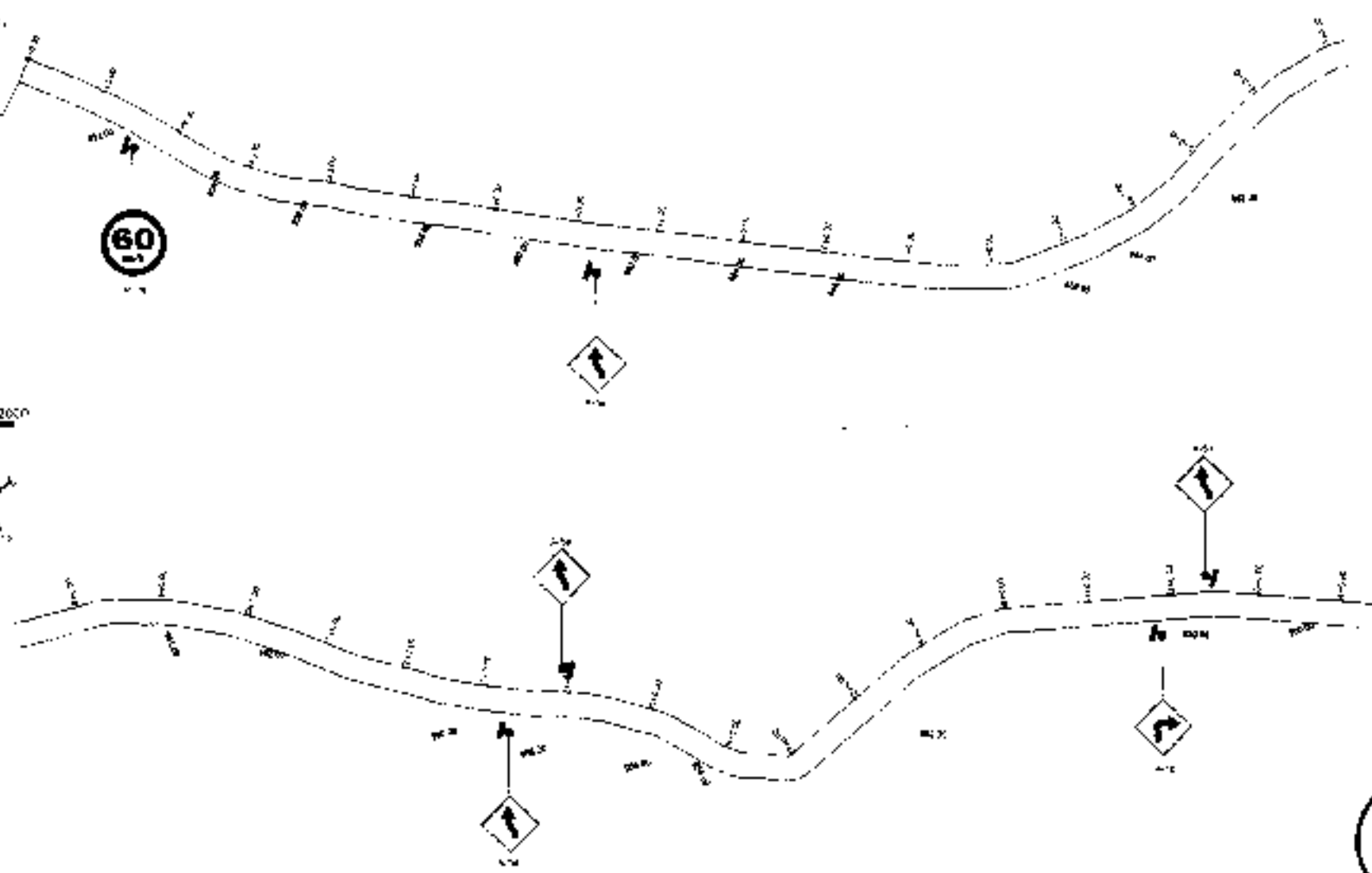

PREFEITURA MUNICIPAL DE GUARACIABA DO NORTE		EMP. N°
RECUPERAÇÃO DE ESTAÇÕES VICINAIS NO MUNICÍPIO DE GUARACIABA DO NORTE-CE - F.º 0862/0-03		1 / 03
SINALIZAÇÃO VIÁRIA		
PROJETO	DR. EDUARDO MOURA DE OLIVEIRA - CREA 11400-0	DATA
APROVADO	DR. EDUARDO MOURA DE OLIVEIRA - CREA 11400-0	11/2008

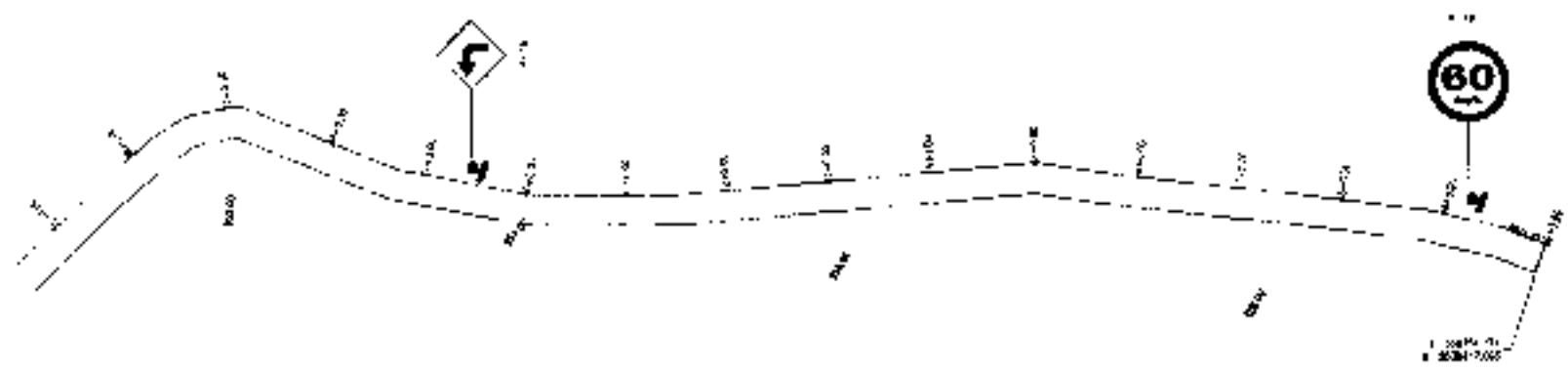

1:2000 2000



 JOÃO BARROS ENGENHARIA	PREFEITURA MUNICIPAL DE GUARACIABA DO NORTE RECUPERAÇÃO DE ESTRADAS VICINAIS NO MUNICÍPIO DE GUARACIABA DO NORTE-CE - PT 1085270-01 SINALIZAÇÃO VIÁRIA		2 / 03
	PROJETO:	DR. JOÃO BARROS ENGENHARIA	11/200
EXECUÇÃO:	DR. JOÃO BARROS ENGENHARIA	11/200	

Posicionamento transversal

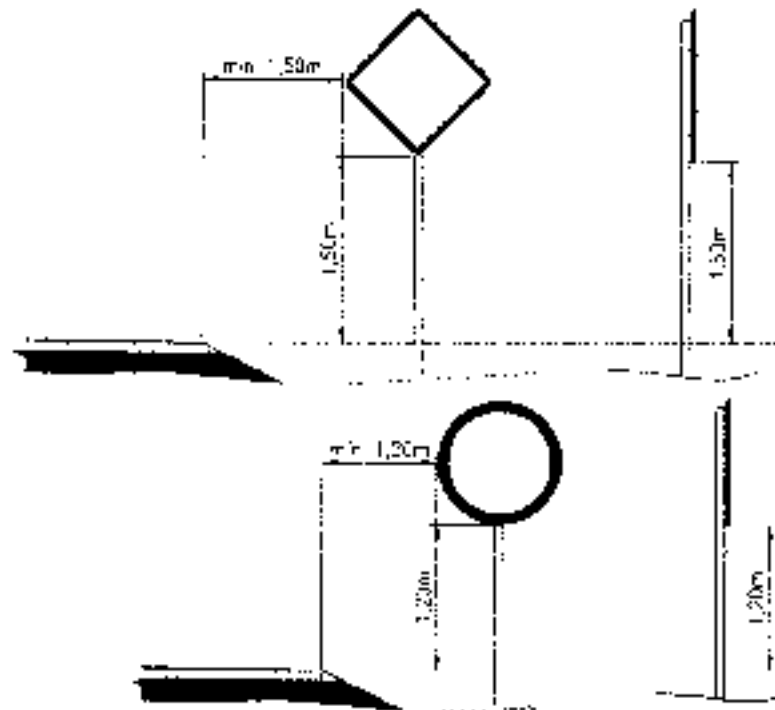

PLACAS DE ADVERTÊNCIA

PLACAS	CODIGO	ANEXO (cm)	QUANTIDADE (un)
	2	30x30	1
	2	30x30	1
	2	30x30	1

PLACAS DE ADVERTÊNCIA

PLACAS	CODIGO	ANEXO (cm)	QUANTIDADE (un)
	1	30x30	1

As Placas de Advertência devem ser colocadas com antecedência de 100m para a esquerda e 100m para a direita da via, exceto quando a via for de mão única, quando deverão ser colocadas apenas à esquerda da via.

As Placas de Advertência devem ser colocadas com antecedência de 100m para a esquerda e 100m para a direita da via, exceto quando a via for de mão única, quando deverão ser colocadas apenas à esquerda da via.

As Placas de Advertência devem ser colocadas com antecedência de 100m para a esquerda e 100m para a direita da via, exceto quando a via for de mão única, quando deverão ser colocadas apenas à esquerda da via.



PREFEITURA MUNICIPAL DE GLARACIOBA DO NORTE
 RECUPERAÇÃO DE ESTRADAS VICINAIS NO MUNICÍPIO DE GLARACIOBA DO NORTE-CE - R.F. 089270-03
 SINALIZAÇÃO VIÁRIA

EMPRESA: [blank]
 ENDEREÇO: [blank]

3 / 03

REN. ESC.

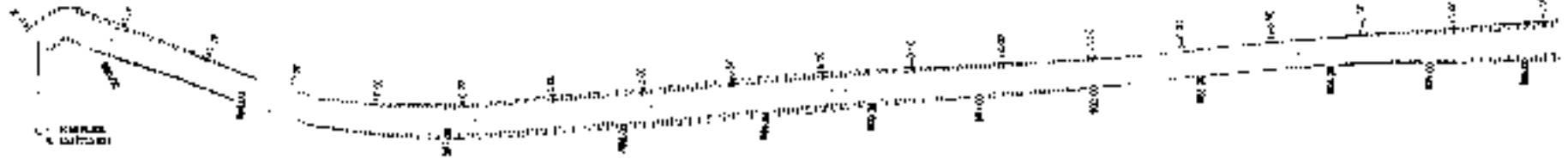
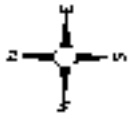

1:1000 2000

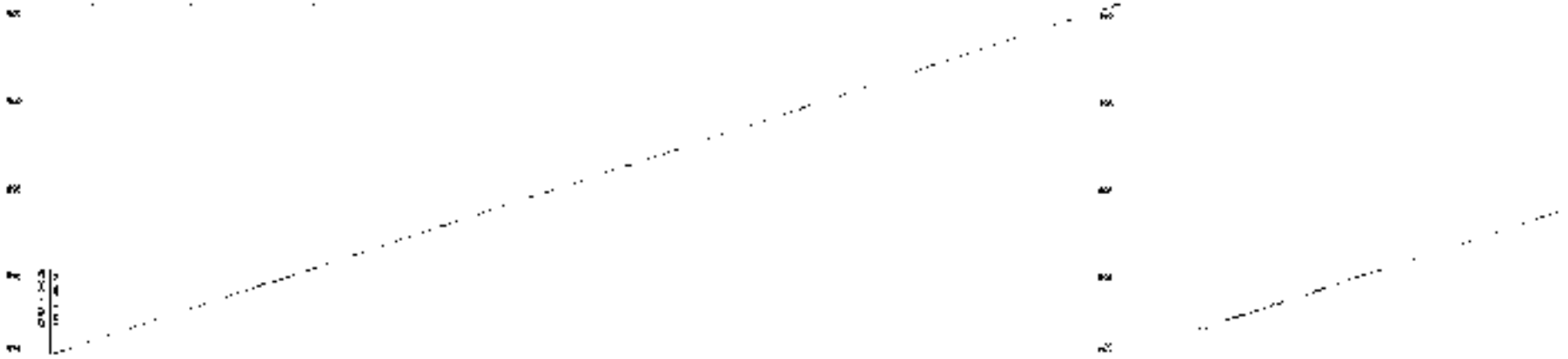

0+00	0+10	0+20	0+30	0+40	0+50	0+60	0+70	0+80	0+90	1+00	1+10	1+20	1+30	1+40	1+50	1+60	1+70	1+80	1+90	2+00
0+00	0+10	0+20	0+30	0+40	0+50	0+60	0+70	0+80	0+90	1+00	1+10	1+20	1+30	1+40	1+50	1+60	1+70	1+80	1+90	2+00
0+00	0+10	0+20	0+30	0+40	0+50	0+60	0+70	0+80	0+90	1+00	1+10	1+20	1+30	1+40	1+50	1+60	1+70	1+80	1+90	2+00

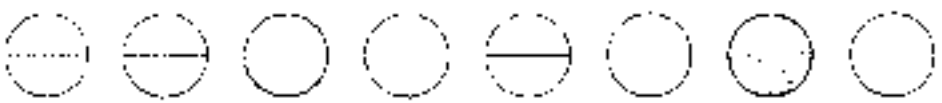

RESERVAÇÃO BARRILADO ESTRADA PAVIMENTO PAVIMENTO PAVIMENTO PAVIMENTO PAVIMENTO



PREFEITURA MUNICIPAL DE GUARACARÁ DO NORTE
 RECUPERAÇÃO DE ESTRADAS VICINAIS NO MUNICÍPIO DE GUARACARÁ DO NORTE - CE - PI 1085270-03
 ESTADQUEAMENTO E PERFIL LONGITUDINAL

PROJETO: [illegible]
 ESCALA: [illegible]



1 / 05
 H 11:00
 2/2010

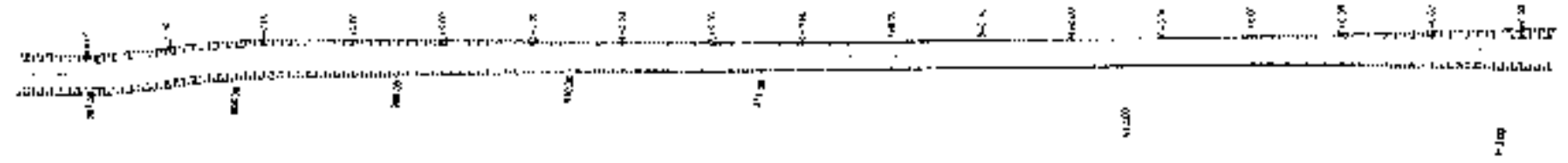

1:1000

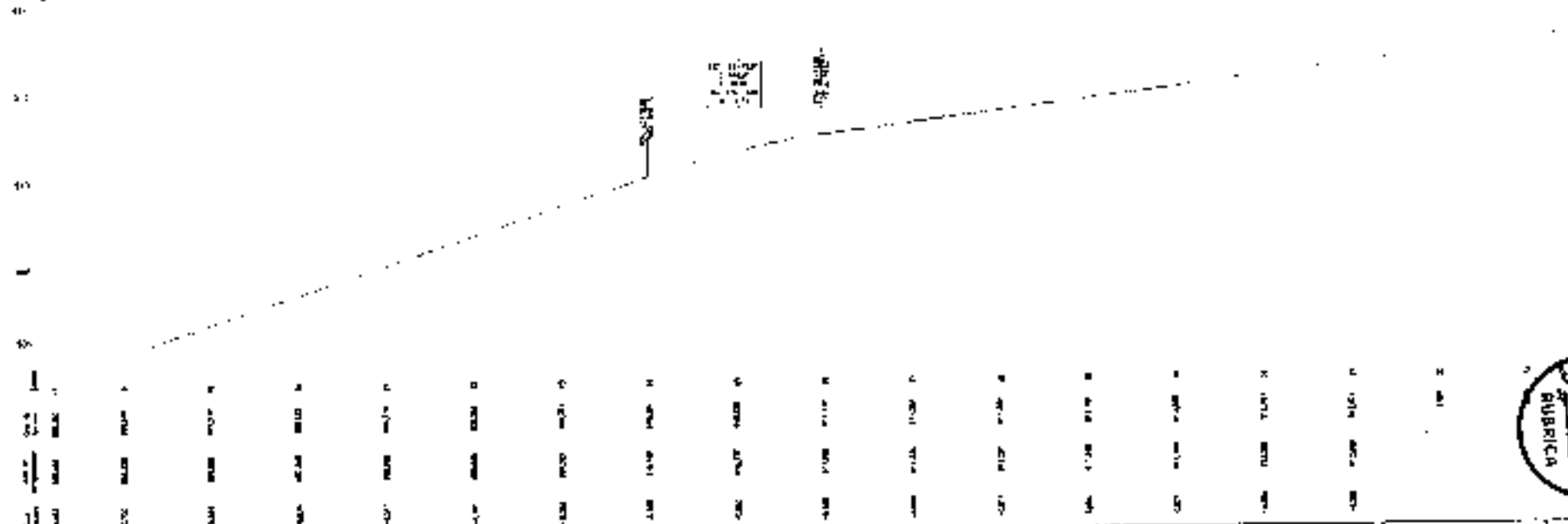

DEFINIÇÃO	DEFINIÇÃO	DEFINIÇÃO	DEFINIÇÃO	DEFINIÇÃO	DEFINIÇÃO	DEFINIÇÃO	DEFINIÇÃO



PREFEITURA MUNICIPAL DE GUARACIABA DO NORTE
 REQUERIMENTO DE ESTUDOS TÉCNICOS PARA O PROJETO DE
 ESTACIONAMENTO E PERFIL LONGITUDINAL

Nº 2 / 06

DATA: 15/05/2006



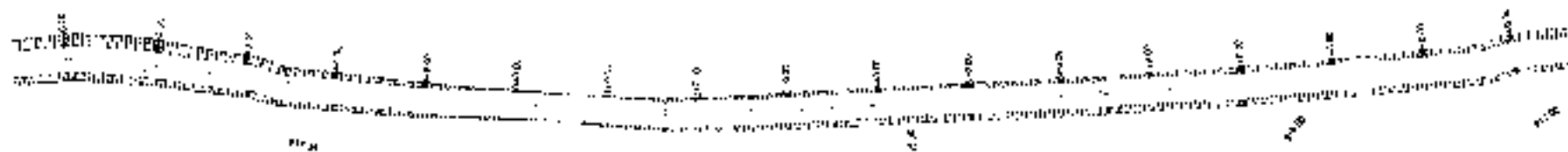

100	101	102	103	104	105	106	107	108	109	110	111	112	113	114	115	116	117	118	119	120	121	122	123	124	125	126	127	128	129	130	131	132	133	134	135	136	137	138	139	140	141	142	143	144	145	146	147	148	149	150	151	152	153	154	155	156	157	158	159	160	161	162	163	164	165	166	167	168	169	170	171	172	173	174	175	176	177	178	179	180	181	182	183	184	185	186	187	188	189	190	191	192	193	194	195	196	197	198	199	200
-----	-----	-----	-----	-----	-----	-----	-----	-----	-----	-----	-----	-----	-----	-----	-----	-----	-----	-----	-----	-----	-----	-----	-----	-----	-----	-----	-----	-----	-----	-----	-----	-----	-----	-----	-----	-----	-----	-----	-----	-----	-----	-----	-----	-----	-----	-----	-----	-----	-----	-----	-----	-----	-----	-----	-----	-----	-----	-----	-----	-----	-----	-----	-----	-----	-----	-----	-----	-----	-----	-----	-----	-----	-----	-----	-----	-----	-----	-----	-----	-----	-----	-----	-----	-----	-----	-----	-----	-----	-----	-----	-----	-----	-----	-----	-----	-----	-----	-----	-----	-----

10m	15m	20m	25m	30m	40m	50m	60m	70m	80m	90m	100m



PREFEITURA MUNICIPAL DE GUARACIABA DO NORTE

REGULPERAÇÃO DE ESTRADAS VICINAIS NO MUNICÍPIO DE GUARACIABA DO NORTE-CE - FT 1086270-03

ESTAQUEAMENTO E PERFIL LONGITUDINAL

PROLATA: DR. CARLOS ALBERTO MONTENEGRO FERREIRA

DATA: 12/08/2010



3706

COMISSÃO DE RUBRICA

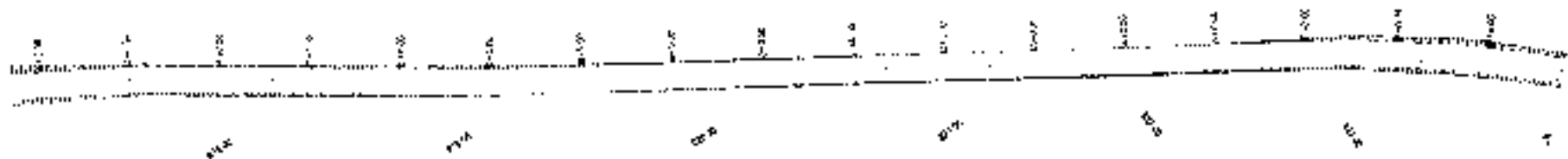
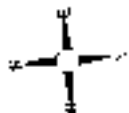

1:1000



Estação	0+00	0+10	0+20	0+30	0+40	0+50	0+60	0+70	0+80	0+90	1+00
Alt. (m)	10.00	10.50	11.00	11.50	12.00	12.50	13.00	13.50	14.00	14.50	15.00
Alt. Proj. (m)	10.00	10.50	11.00	11.50	12.00	12.50	13.00	13.50	14.00	14.50	15.00
Alt. (m)	10.00	10.50	11.00	11.50	12.00	12.50	13.00	13.50	14.00	14.50	15.00



PREFEITURA MUNICIPAL DE GUARACIABA DO NORTE
 RECUPERAÇÃO DE ESTRADAS VICINAIS NO MUNICÍPIO DE GUARACIABA DO NORTE-CE - P 1066270-03
 ESTAQUEAMENTO E PERFIL LONGITUDINAL

4 / 06



1:1000 2000

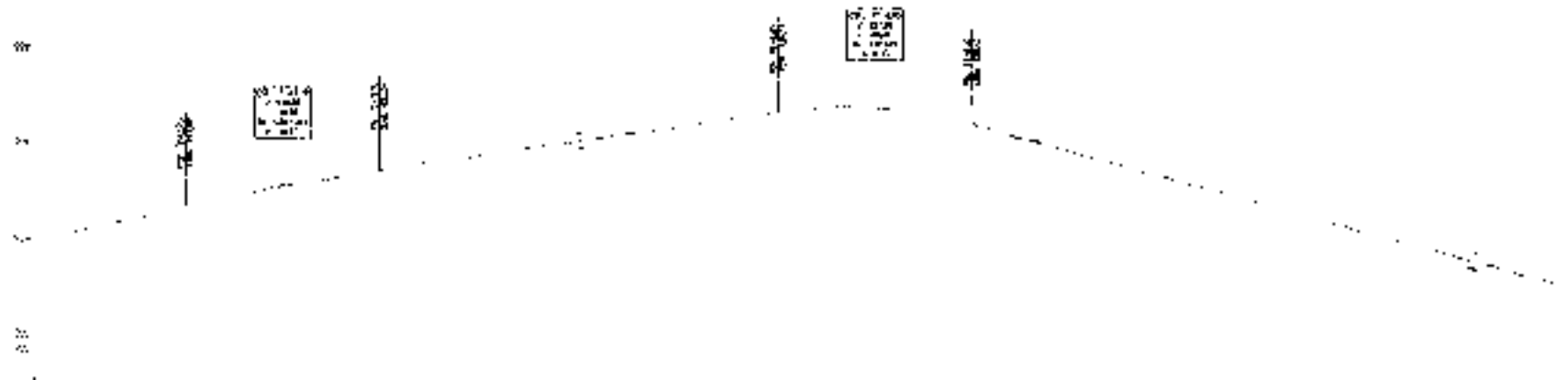
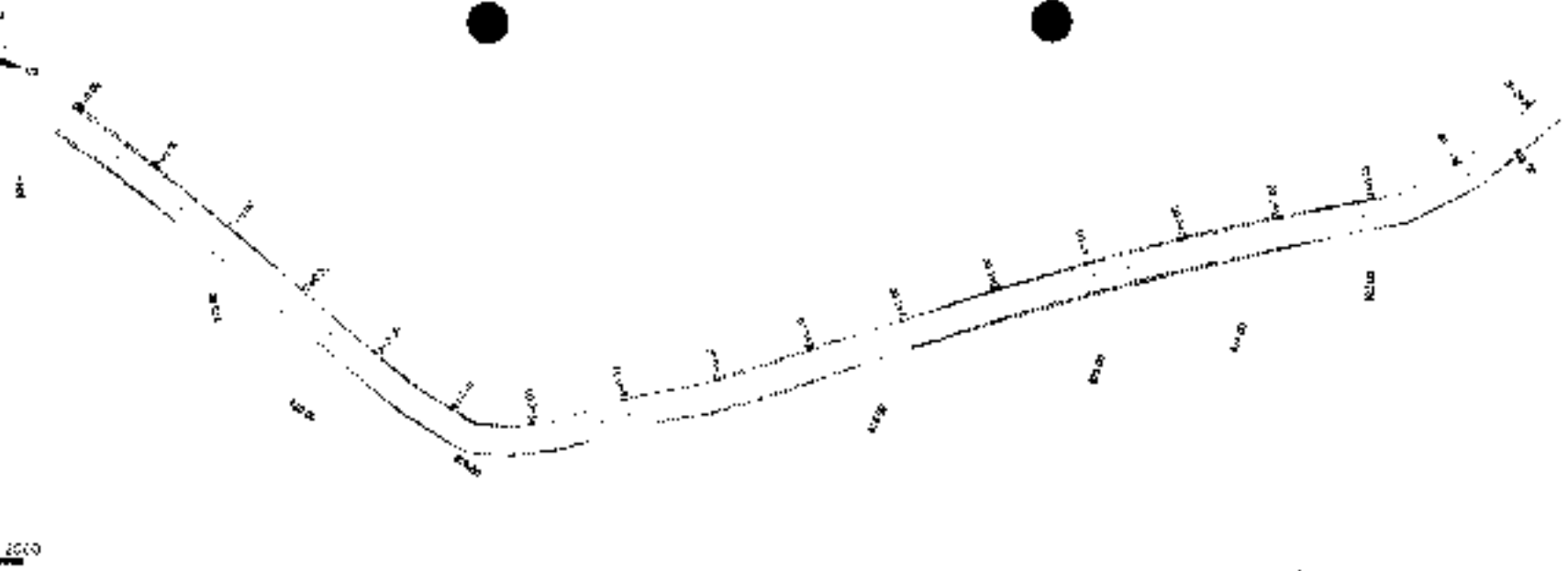

0+00	0+10	0+20	0+30	0+40	0+50	0+60	0+70	0+80	0+90	1+00
100	110	120	130	140	150	160	170	180	190	200
100	110	120	130	140	150	160	170	180	190	200
100	110	120	130	140	150	160	170	180	190	200





PREFEITURA MUNICIPAL DE GUARACIABA DO NORTE	
RECUPERAÇÃO DE ESTRADAS VICINAIS NO MUNICÍPIO DE GUARACIABA DO NORTE-CE - PI 1086270-03	
ESTAQUEAMENTO E PERFIL LONGITUDINAL	
PROJETO	DR. CARLOS AUGUSTO DE LIMA OLIVEIRA
AUTOR	FELIPE MOTA MORAES DE OLIVEIRA

5 / 05

2024

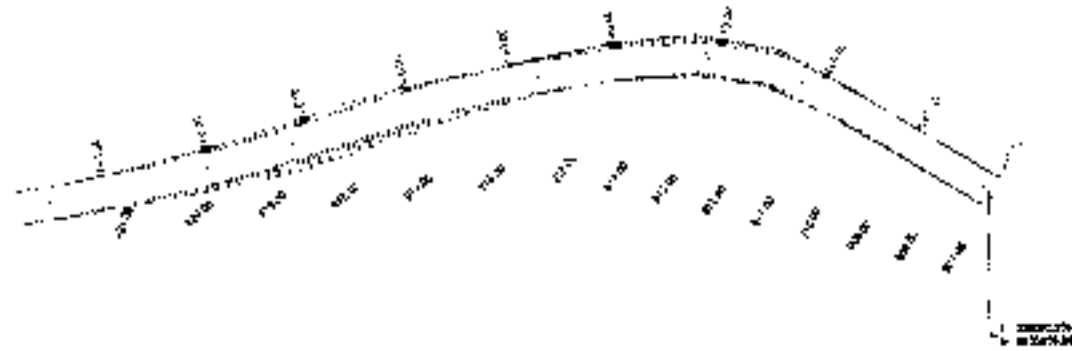

0 100 200

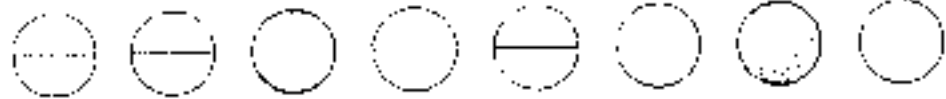
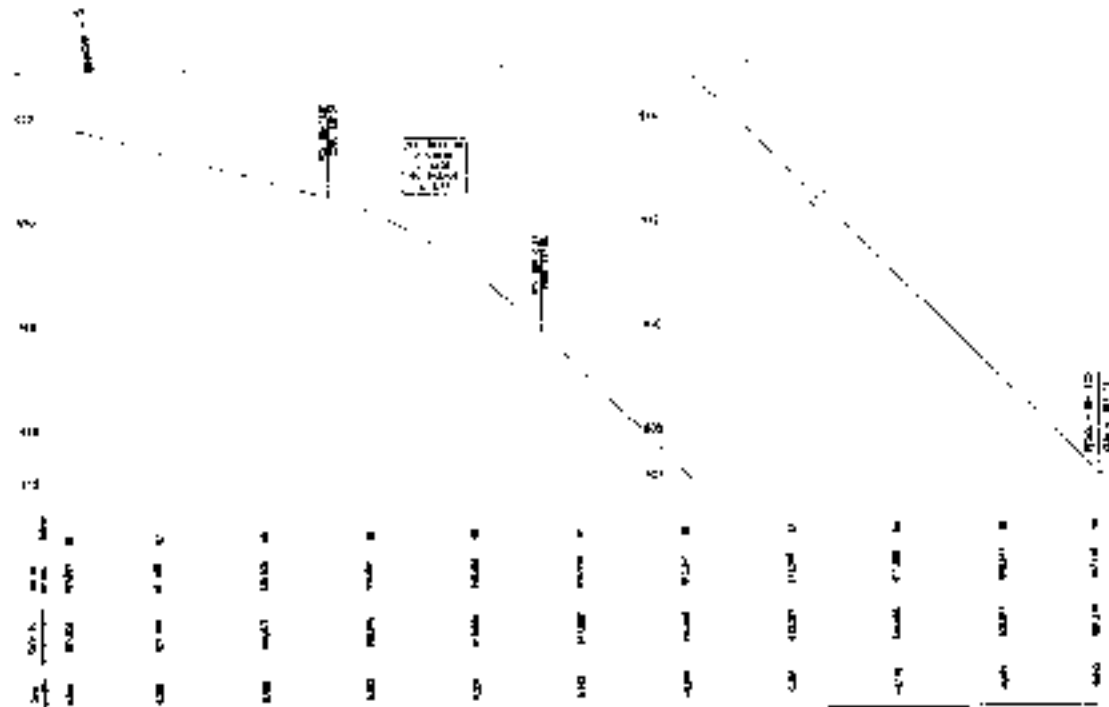

PREFEITURA MUNICIPAL DE GUARACIABA DO NORTE
 RECUPERAÇÃO DE ESTRADAS VICINAIS NO MUNICÍPIO DE GUARACIABA DO NORTE-GE - PI 1198270-00
 EBIAQUEAMENTO E PERFIL LONGITUDINAL

PROJETO: PROJETO DE RECONSTRUÇÃO DE ESTRADAS VICINAIS
 LOCAL: RUA JOSEFA DE ALMEIDA, 1000 - CENTRO



6 / 06

27/06/2012

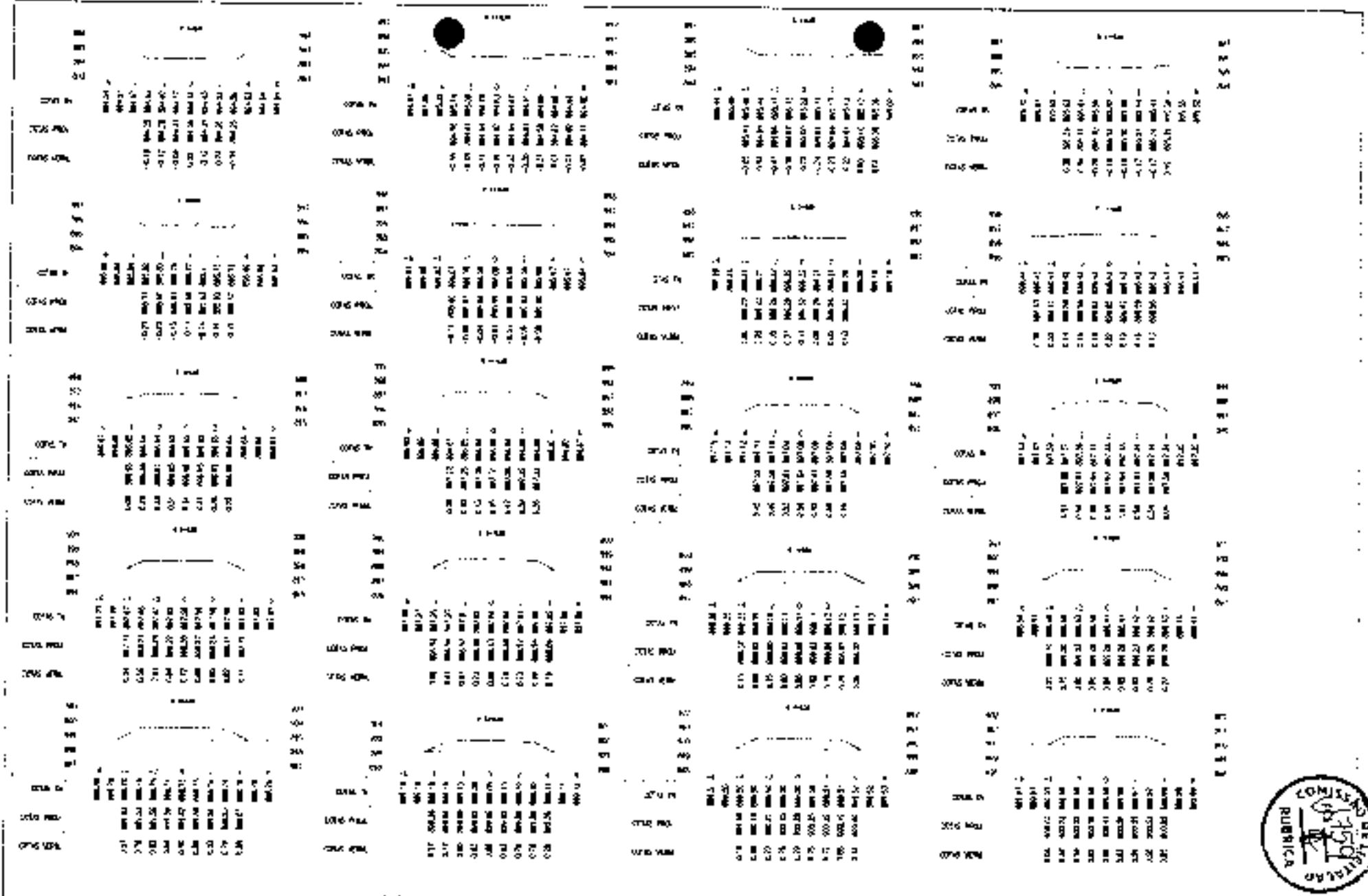

LEGENDA

- ALIESO
- CORIE



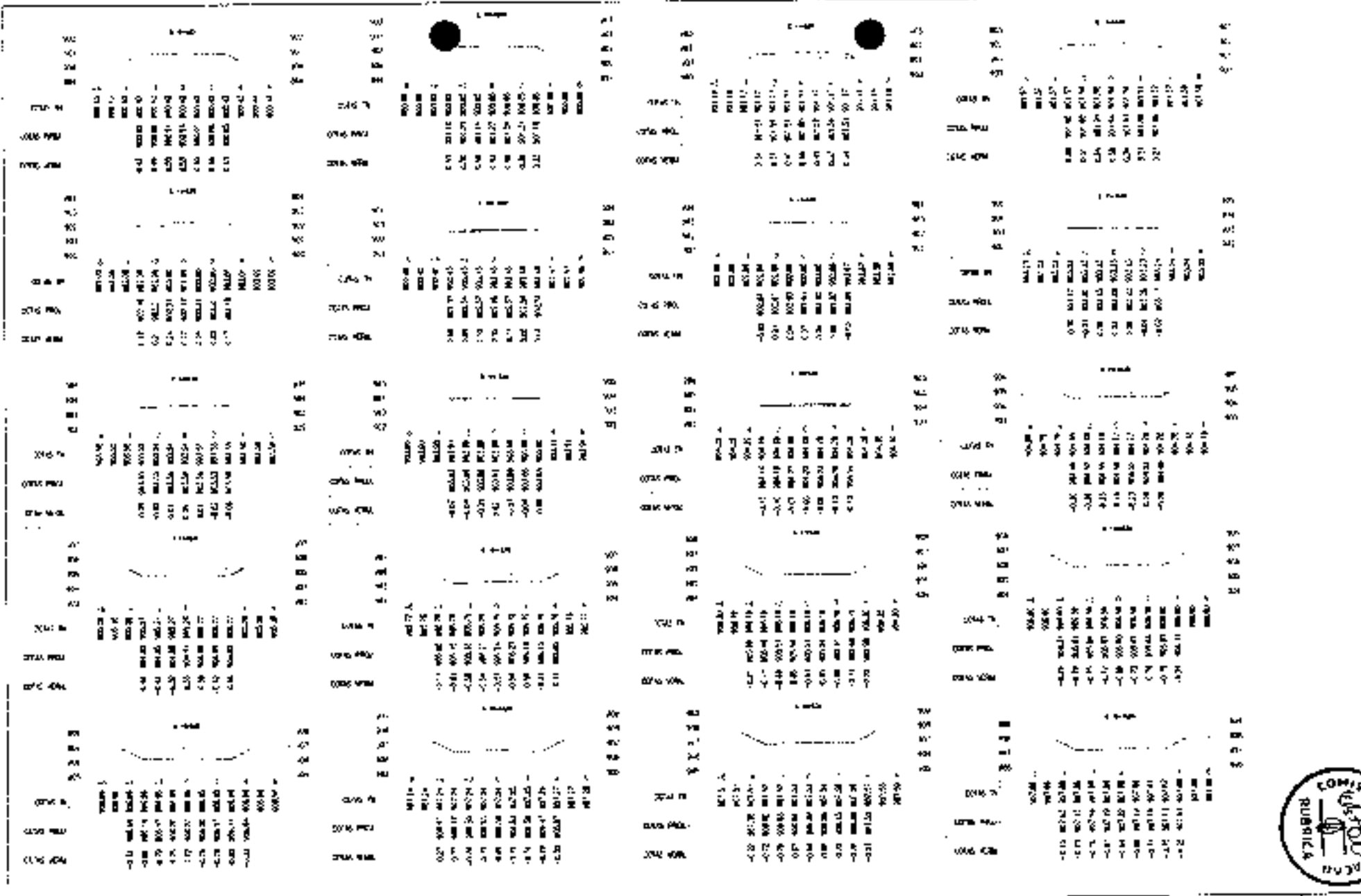
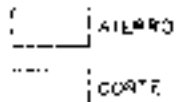

PREFEITURA MUNICIPAL DE GUARACIABA DO NORTE		
REQUALIFICAÇÃO DE ESTRADAS VICINAIS NO MUNICÍPIO DE GUARACIABA DO NORTE-CE - PT 138273-00		
SEÇÕES TRANSVERSAIS		118
PROJETO	PROJ. DE REQUALIFICAÇÃO DE ESTRADAS VICINAIS NO MUNICÍPIO DE GUARACIABA DO NORTE-CE - PT 138273-00	1/200
PROJ. ARQ.	PROJ. DE REQUALIFICAÇÃO DE ESTRADAS VICINAIS NO MUNICÍPIO DE GUARACIABA DO NORTE-CE - PT 138273-00	

LEGENDA



LEGENDA

-  ATERRO
-  CORTA

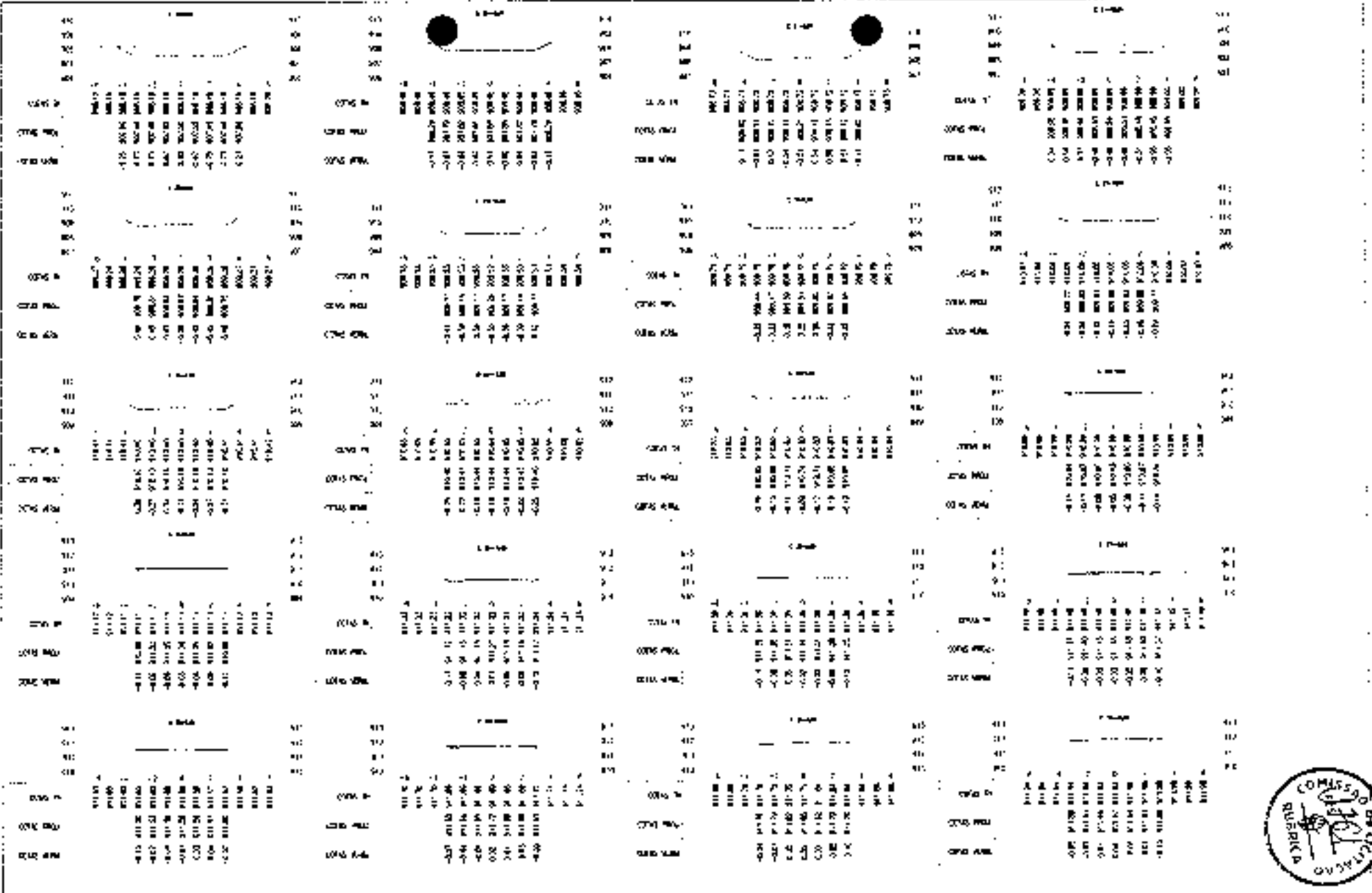

	PREFEITURA MUNICIPAL DE GUARACIAMA DO NORTE RECUPERAÇÃO DE ESTRADAS VICINAIS NO MUNICÍPIO DE GUARACIAMA DO NORTE-CE - PT 1096270-D0		Folha nº 3 / 13
	SEÇÕES TRANSVERSAIS		Data:
	Projeto:	01 - 02 - 03 - 04 - 05 - 06 - 07 - 08 - 09 - 10 - 11 - 12 - 13 - 14 - 15 - 16 - 17 - 18 - 19 - 20 - 21 - 22 - 23 - 24 - 25 - 26 - 27 - 28 - 29 - 30 - 31 - 32 - 33 - 34 - 35 - 36 - 37 - 38 - 39 - 40 - 41 - 42 - 43 - 44 - 45 - 46 - 47 - 48 - 49 - 50 - 51 - 52 - 53 - 54 - 55 - 56 - 57 - 58 - 59 - 60 - 61 - 62 - 63 - 64 - 65 - 66 - 67 - 68 - 69 - 70 - 71 - 72 - 73 - 74 - 75 - 76 - 77 - 78 - 79 - 80 - 81 - 82 - 83 - 84 - 85 - 86 - 87 - 88 - 89 - 90 - 91 - 92 - 93 - 94 - 95 - 96 - 97 - 98 - 99 - 100	1988



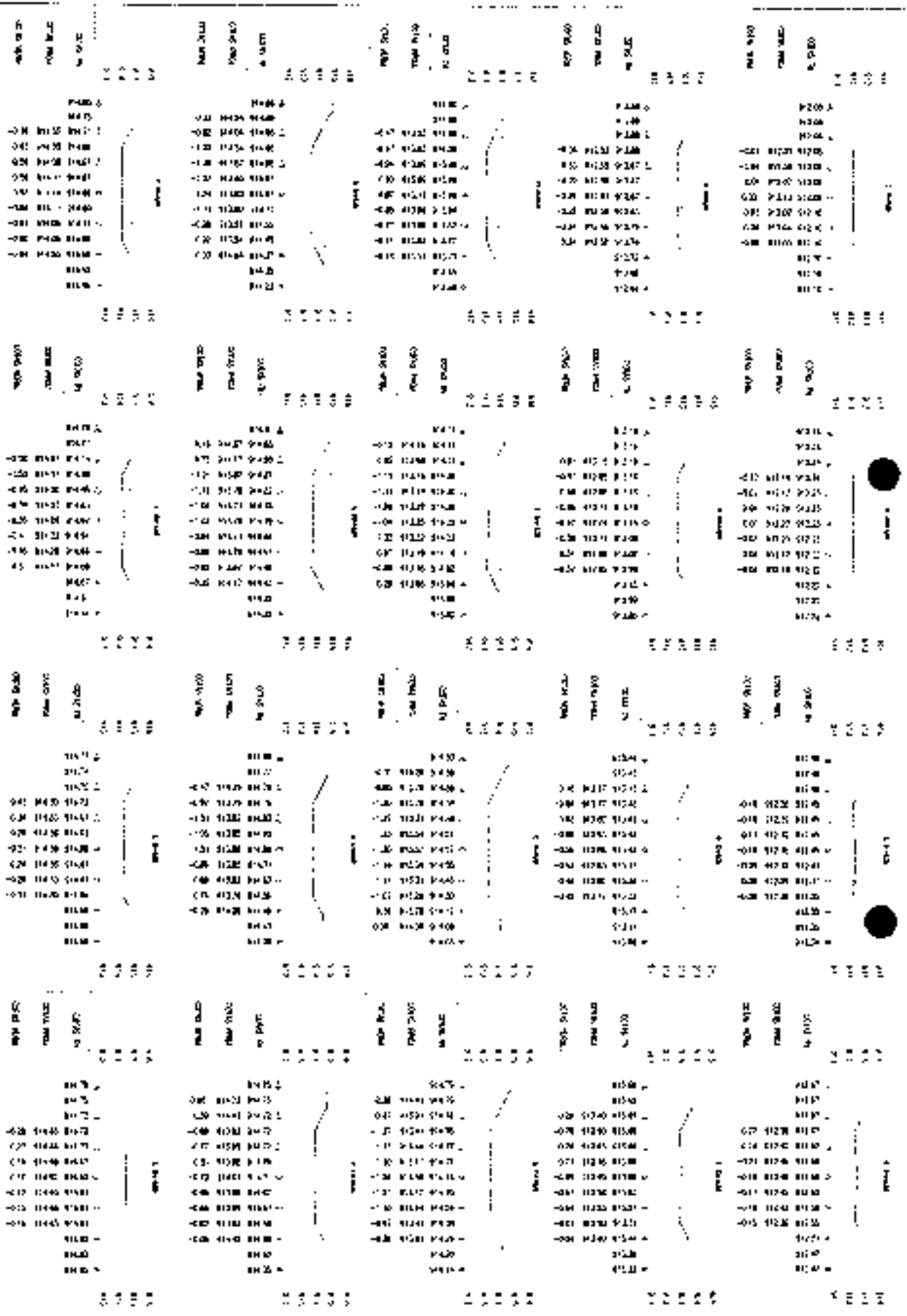

LEGENDA

ATERRO
CORTE



PREFEITURA MUNICIPAL DE GUARACIABA DO NORTE

RECUPERAÇÃO DE ESTRADAS VICINAIS NO MUNICÍPIO DE GUARACIABA DO NORTE-CE - PM 1088/2004

SEÇÕES TRANSVERSAIS

4 / NO



Item	Descrição	Valor	Item	Descrição	Valor	Item	Descrição	Valor	Item	Descrição	Valor
001	002	003	004

LEGENDA

ACERVO

CORTE



PREFEITURA MUNICIPAL DE GUARACEMA, RJ

RECUPERAÇÃO DE ESTADOS VACANTES NO MUNICÍPIO DE GUARACEMA DO NORTE - CE - PT JOSETRONIS

SEÇÃO INVENTARIAIS

5 / 15

1226



Nº 001/2014
 Nº 002/2014
 Nº 003/2014
 Nº 004/2014
 Nº 005/2014
 Nº 006/2014
 Nº 007/2014
 Nº 008/2014
 Nº 009/2014
 Nº 010/2014
 Nº 011/2014
 Nº 012/2014
 Nº 013/2014
 Nº 014/2014
 Nº 015/2014
 Nº 016/2014
 Nº 017/2014
 Nº 018/2014
 Nº 019/2014
 Nº 020/2014
 Nº 021/2014
 Nº 022/2014
 Nº 023/2014
 Nº 024/2014
 Nº 025/2014
 Nº 026/2014
 Nº 027/2014
 Nº 028/2014
 Nº 029/2014
 Nº 030/2014
 Nº 031/2014
 Nº 032/2014
 Nº 033/2014
 Nº 034/2014
 Nº 035/2014
 Nº 036/2014
 Nº 037/2014
 Nº 038/2014
 Nº 039/2014
 Nº 040/2014
 Nº 041/2014
 Nº 042/2014
 Nº 043/2014
 Nº 044/2014
 Nº 045/2014
 Nº 046/2014
 Nº 047/2014
 Nº 048/2014
 Nº 049/2014
 Nº 050/2014
 Nº 051/2014
 Nº 052/2014
 Nº 053/2014
 Nº 054/2014
 Nº 055/2014
 Nº 056/2014
 Nº 057/2014
 Nº 058/2014
 Nº 059/2014
 Nº 060/2014
 Nº 061/2014
 Nº 062/2014
 Nº 063/2014
 Nº 064/2014
 Nº 065/2014
 Nº 066/2014
 Nº 067/2014
 Nº 068/2014
 Nº 069/2014
 Nº 070/2014
 Nº 071/2014
 Nº 072/2014
 Nº 073/2014
 Nº 074/2014
 Nº 075/2014
 Nº 076/2014
 Nº 077/2014
 Nº 078/2014
 Nº 079/2014
 Nº 080/2014
 Nº 081/2014
 Nº 082/2014
 Nº 083/2014
 Nº 084/2014
 Nº 085/2014
 Nº 086/2014
 Nº 087/2014
 Nº 088/2014
 Nº 089/2014
 Nº 090/2014
 Nº 091/2014
 Nº 092/2014
 Nº 093/2014
 Nº 094/2014
 Nº 095/2014
 Nº 096/2014
 Nº 097/2014
 Nº 098/2014
 Nº 099/2014
 Nº 100/2014

PREFEITURA MUNICIPAL DE GUARACIABA DO NORTE
 RECUPERAÇÃO DE ESTRADAS VICINAIS NO MUNICÍPIO DE GUARACIABA DO NORTE-CE - R.T. 106270-02
 SEÇÃO TRANSPORTES
 DATA: 02/05/2014
 VALOR: R\$ 1.000.000,00
 Nº 001/2014
 Nº 002/2014
 Nº 003/2014
 Nº 004/2014
 Nº 005/2014
 Nº 006/2014
 Nº 007/2014
 Nº 008/2014
 Nº 009/2014
 Nº 010/2014
 Nº 011/2014
 Nº 012/2014
 Nº 013/2014
 Nº 014/2014
 Nº 015/2014
 Nº 016/2014
 Nº 017/2014
 Nº 018/2014
 Nº 019/2014
 Nº 020/2014
 Nº 021/2014
 Nº 022/2014
 Nº 023/2014
 Nº 024/2014
 Nº 025/2014
 Nº 026/2014
 Nº 027/2014
 Nº 028/2014
 Nº 029/2014
 Nº 030/2014
 Nº 031/2014
 Nº 032/2014
 Nº 033/2014
 Nº 034/2014
 Nº 035/2014
 Nº 036/2014
 Nº 037/2014
 Nº 038/2014
 Nº 039/2014
 Nº 040/2014
 Nº 041/2014
 Nº 042/2014
 Nº 043/2014
 Nº 044/2014
 Nº 045/2014
 Nº 046/2014
 Nº 047/2014
 Nº 048/2014
 Nº 049/2014
 Nº 050/2014
 Nº 051/2014
 Nº 052/2014
 Nº 053/2014
 Nº 054/2014
 Nº 055/2014
 Nº 056/2014
 Nº 057/2014
 Nº 058/2014
 Nº 059/2014
 Nº 060/2014
 Nº 061/2014
 Nº 062/2014
 Nº 063/2014
 Nº 064/2014
 Nº 065/2014
 Nº 066/2014
 Nº 067/2014
 Nº 068/2014
 Nº 069/2014
 Nº 070/2014
 Nº 071/2014
 Nº 072/2014
 Nº 073/2014
 Nº 074/2014
 Nº 075/2014
 Nº 076/2014
 Nº 077/2014
 Nº 078/2014
 Nº 079/2014
 Nº 080/2014
 Nº 081/2014
 Nº 082/2014
 Nº 083/2014
 Nº 084/2014
 Nº 085/2014
 Nº 086/2014
 Nº 087/2014
 Nº 088/2014
 Nº 089/2014
 Nº 090/2014
 Nº 091/2014
 Nº 092/2014
 Nº 093/2014
 Nº 094/2014
 Nº 095/2014
 Nº 096/2014
 Nº 097/2014
 Nº 098/2014
 Nº 099/2014
 Nº 100/2014

LEGENDA

ALCANTARA

CAATF



	PREFEITURA MUNICIPAL DE GUARACIABA DO NORTE RECUPERAÇÃO DE ESTRADAS VICINAIS AO MUNICÍPIO DE GUARACIABA DO NORTE - CE - P1 (0362 KM) SEÇÕES TRANSVERSAIS		1:500 B / 10
	PROPOSTA Mês/Ano	Nº DA ORÇAMENTARIA Nº DA LICITACAO	DATA VALOR

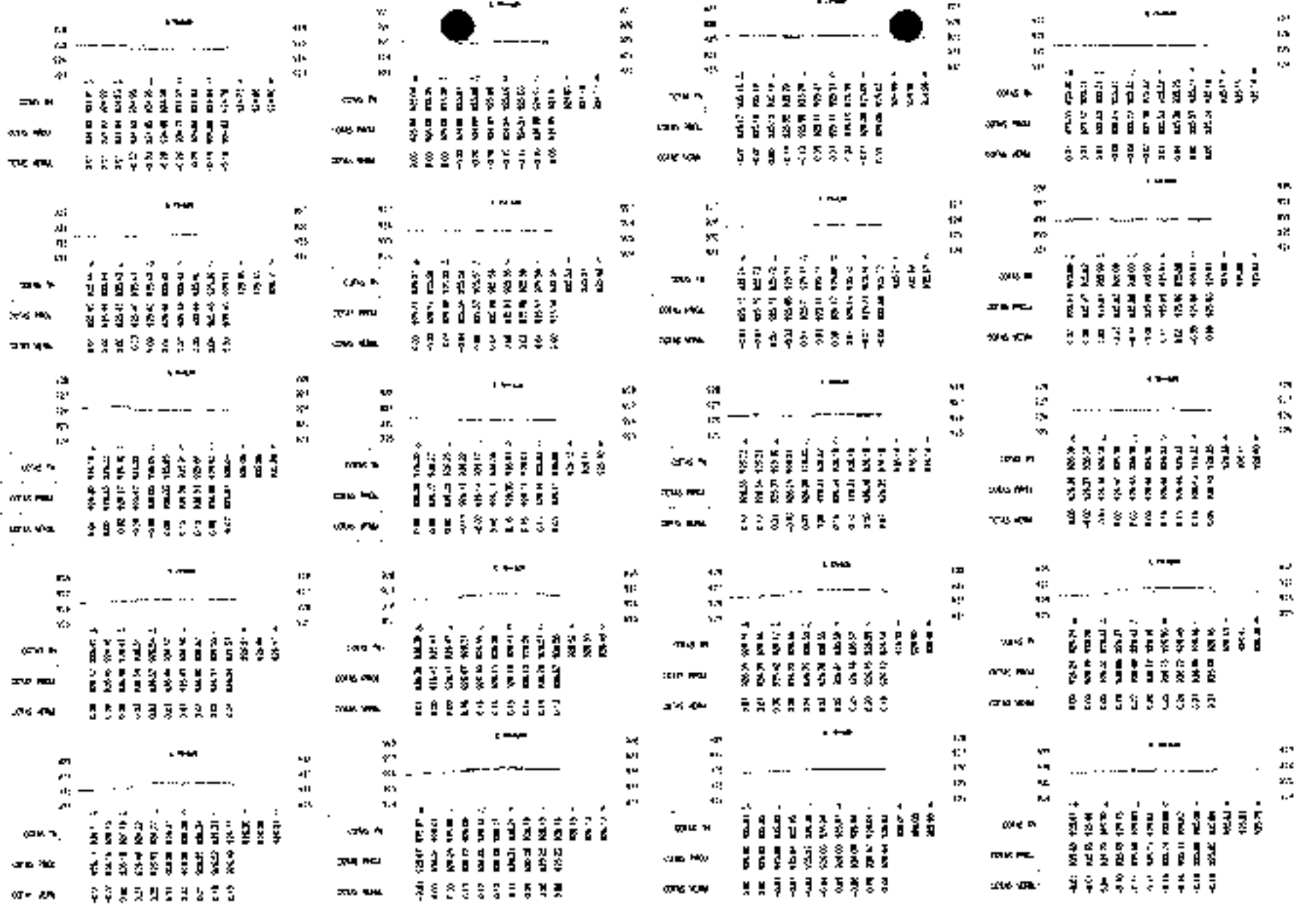

LEGENDA

ATERRO
 CORTA

Item	Descrição	Quantidade	Valor Unitário	Valor Total
01
02
03
04
05
06
07
08
09
10
11
12
13
14
15
16
17
18
19
20
21
22
23
24
25
26
27
28
29
30
31
32
33
34
35
36
37
38
39
40
41
42
43
44
45
46
47
48
49
50
51
52
53
54
55
56
57
58
59
60
61
62
63
64
65
66
67
68
69
70
71
72
73
74
75
76
77
78
79
80
81
82
83
84
85
86
87
88
89
90
91
92
93
94
95
96
97
98
99
100

LEGENDA

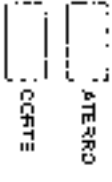

PREFEITURA MUNICIPAL DE QUARACIANGA DO NORTE

RECUPERAÇÃO DE ESTRADAS VICINAIS NO MUNICÍPIO DE QUARACIANGA DO NORTE-CE - R10062/2000

SEÇÕES TRANSITÓRIAS

ATA Nº 001/2000

DATA: 20/08/2000

LOCAL: QUARACIANGA DO NORTE-CE



REP. MUN.	REP. MUN.	REP. MUN.	REP. MUN.
001	002	003	004
005	006	007	008
009	010	011	012
013	014	015	016
017	018	019	020
021	022	023	024
025	026	027	028
029	030	031	032
033	034	035	036
037	038	039	040
041	042	043	044
045	046	047	048
049	050	051	052
053	054	055	056
057	058	059	060
061	062	063	064
065	066	067	068
069	070	071	072
073	074	075	076
077	078	079	080
081	082	083	084
085	086	087	088
089	090	091	092
093	094	095	096
097	098	099	100

REP. MUN.	REP. MUN.	REP. MUN.	REP. MUN.
101	102	103	104
105	106	107	108
109	110	111	112
113	114	115	116
117	118	119	120
121	122	123	124
125	126	127	128
129	130	131	132
133	134	135	136
137	138	139	140
141	142	143	144
145	146	147	148
149	150	151	152
153	154	155	156
157	158	159	160
161	162	163	164
165	166	167	168
169	170	171	172
173	174	175	176
177	178	179	180
181	182	183	184
185	186	187	188
189	190	191	192
193	194	195	196
197	198	199	200

REP. MUN.	REP. MUN.	REP. MUN.	REP. MUN.
201	202	203	204
205	206	207	208
209	210	211	212
213	214	215	216
217	218	219	220
221	222	223	224
225	226	227	228
229	230	231	232
233	234	235	236
237	238	239	240
241	242	243	244
245	246	247	248
249	250	251	252
253	254	255	256
257	258	259	260
261	262	263	264
265	266	267	268
269	270	271	272
273	274	275	276
277	278	279	280
281	282	283	284
285	286	287	288
289	290	291	292
293	294	295	296
297	298	299	300

REP. MUN.	REP. MUN.	REP. MUN.	REP. MUN.
301	302	303	304
305	306	307	308
309	310	311	312
313	314	315	316
317	318	319	320
321	322	323	324
325	326	327	328
329	330	331	332
333	334	335	336
337	338	339	340
341	342	343	344
345	346	347	348
349	350	351	352
353	354	355	356
357	358	359	360
361	362	363	364
365	366	367	368
369	370	371	372
373	374	375	376
377	378	379	380
381	382	383	384
385	386	387	388
389	390	391	392
393	394	395	396
397	398	399	400

REP. MUN.	REP. MUN.	REP. MUN.	REP. MUN.
401	402	403	404
405	406	407	408
409	410	411	412
413	414	415	416
417	418	419	420
421	422	423	424
425	426	427	428
429	430	431	432
433	434	435	436
437	438	439	440
441	442	443	444
445	446	447	448
449	450	451	452
453	454	455	456
457	458	459	460
461	462	463	464
465	466	467	468
469	470	471	472
473	474	475	476
477	478	479	480
481	482	483	484
485	486	487	488
489	490	491	492
493	494	495	496
497	498	499	500

LEGENDA

ATERRO

CORTE

ATA BUNDOS
PH. L. E. 03

PRESIDENTE MUNICIPAL DE GUARACIABA DO NORTE

RECUPERAÇÃO DE ESTERCOAS VULGARES NA M. U. R. C. P. IN. C. F. GUARACIABA DO NORTE - PE. T. I. D. R. E. C. T. O. R. I. O. S. S. E. C. I. O. E. S. T. A. N. N. I. E. R. S. I. A. S.

10 / 10

1750



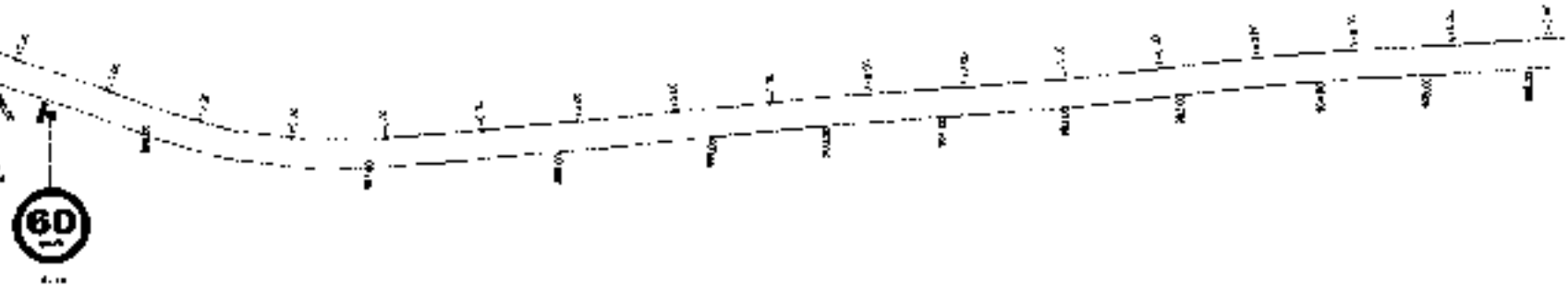

0 1000 2000

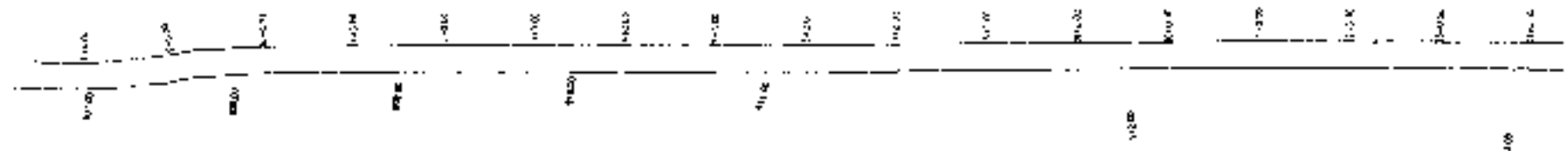

0 1000 2000



	PREFEITURA MUNICIPAL DE GUARACIABA DO NORTE REQUALIFICAÇÃO DE ESTRADAS VICINIAS NO MUNICÍPIO DE GUARACIABA DO NORTE-CE - R.T. 10852/1100		Nº 001/2014
	SINALIZAÇÃO VIÁRIA		1 / 04
ANEXO 1/2014 PROJETO	DE QUALIFICAÇÃO E SINALIZAÇÃO DE VIAS DE RUAIS VICINARIAS E INTERMUNICIPAIS		1/2014

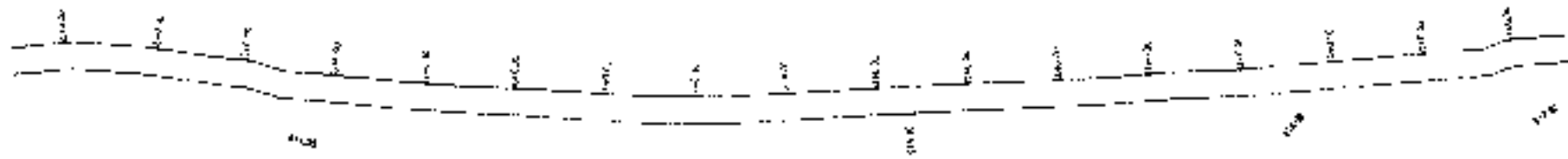
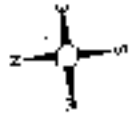

1:1000 2300

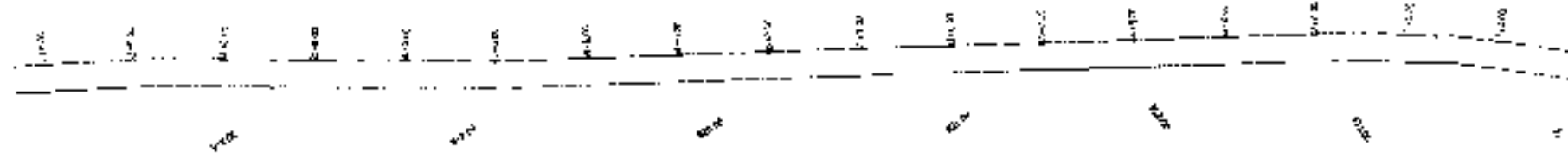

1:1000 2600



	PREFEITURA MUNICIPAL DE GARÇA DO NORTE REGISTRAÇÃO DE ESTRADAS VICINAIS NO MUNICÍPIO DE GARÇA DO NORTE/CE - PI 1000273-03		2 / 04
	BINALIZAÇÃO VIÁRIA		14/00
ENDEREÇO: RUA CARVALHO MENEZES, 100 - GARÇA DO NORTE - CE	DATA: 14/05/2007		14/00
ANEXO: DE PLANILHA DE BINALIZAÇÃO DE ESTRADAS VICINAIS			

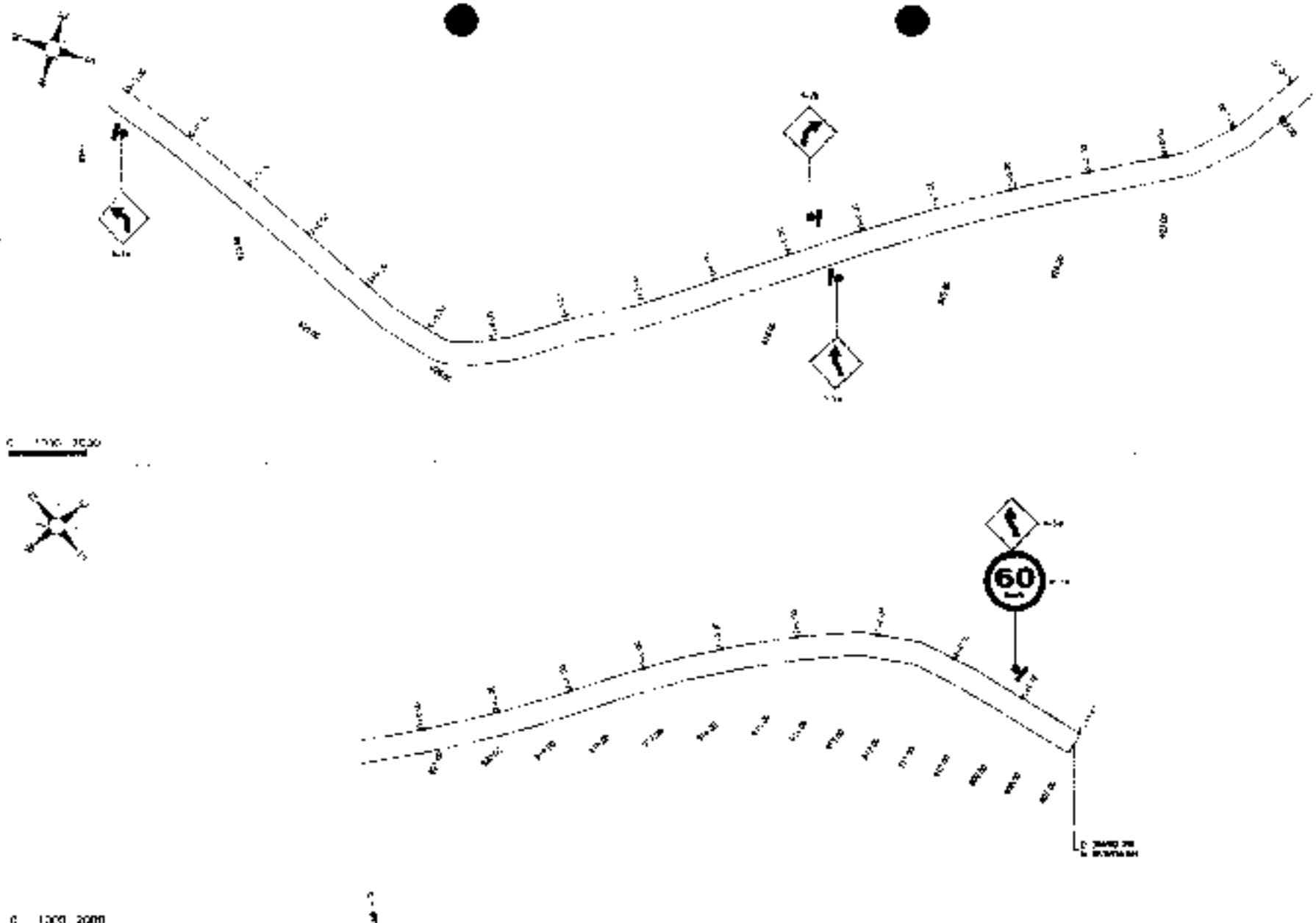

<p>JOTA BARROS S.R.L.</p>	PREFEITURA MUNICIPAL DE GUARACABA DO NORTE REABARBAÇÃO DE ESTRADAS VIZINHAS NO MUNICÍPIO DE GUARACABA DO NORTE-DF - PT 1396273-00 SINALIZAÇÃO VIÁRIA		3 / 06
	REALIZADO POR: ENG. CIVIL AFRÊNIO WILSON FERREIRA LIMA (1396273-00) VIGENTE DE: 04/06/2011 ATÉ: 04/06/2012		

Posicionamento Transversal

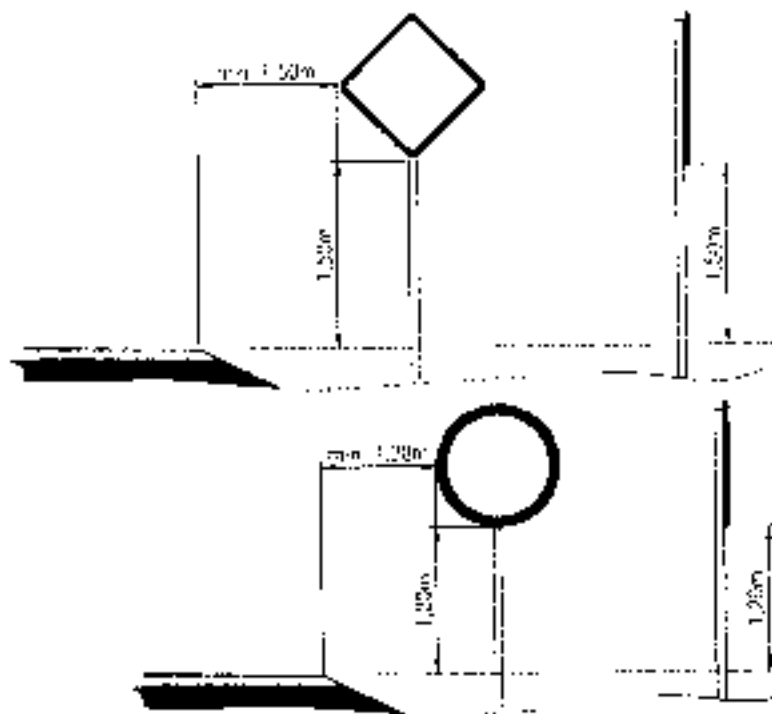

PLACAS DE ADVERTÊNCIA

PLACAS	CÓDIGO	DESCRIÇÃO (m)	QUANTIDADE (un)
	02	60 km/h	01

PLACAS	CÓDIGO	DESCRIÇÃO (m)	QUANTIDADE (un)
01	01	Advertência de curva à esquerda	01
01	02	Advertência de curva à direita	01
01	03	Advertência de curva a esquerda e a direita	01
01	04	Advertência de curva fechada à esquerda	01
01	05	Advertência de curva fechada à direita	01
01	06	Advertência de curva fechada a esquerda e a direita	01
01	07	Advertência de curva fechada à esquerda e à direita	01
01	08	Advertência de curva fechada à esquerda e à direita	01
01	09	Advertência de curva fechada à esquerda e à direita	01
01	10	Advertência de curva fechada à esquerda e à direita	01
01	11	Advertência de curva fechada à esquerda e à direita	01
01	12	Advertência de curva fechada à esquerda e à direita	01
01	13	Advertência de curva fechada à esquerda e à direita	01
01	14	Advertência de curva fechada à esquerda e à direita	01
01	15	Advertência de curva fechada à esquerda e à direita	01
01	16	Advertência de curva fechada à esquerda e à direita	01
01	17	Advertência de curva fechada à esquerda e à direita	01
01	18	Advertência de curva fechada à esquerda e à direita	01
01	19	Advertência de curva fechada à esquerda e à direita	01
01	20	Advertência de curva fechada à esquerda e à direita	01
01	21	Advertência de curva fechada à esquerda e à direita	01
01	22	Advertência de curva fechada à esquerda e à direita	01
01	23	Advertência de curva fechada à esquerda e à direita	01
01	24	Advertência de curva fechada à esquerda e à direita	01
01	25	Advertência de curva fechada à esquerda e à direita	01
01	26	Advertência de curva fechada à esquerda e à direita	01
01	27	Advertência de curva fechada à esquerda e à direita	01
01	28	Advertência de curva fechada à esquerda e à direita	01
01	29	Advertência de curva fechada à esquerda e à direita	01
01	30	Advertência de curva fechada à esquerda e à direita	01
01	31	Advertência de curva fechada à esquerda e à direita	01
01	32	Advertência de curva fechada à esquerda e à direita	01
01	33	Advertência de curva fechada à esquerda e à direita	01
01	34	Advertência de curva fechada à esquerda e à direita	01
01	35	Advertência de curva fechada à esquerda e à direita	01
01	36	Advertência de curva fechada à esquerda e à direita	01
01	37	Advertência de curva fechada à esquerda e à direita	01
01	38	Advertência de curva fechada à esquerda e à direita	01
01	39	Advertência de curva fechada à esquerda e à direita	01
01	40	Advertência de curva fechada à esquerda e à direita	01
01	41	Advertência de curva fechada à esquerda e à direita	01
01	42	Advertência de curva fechada à esquerda e à direita	01
01	43	Advertência de curva fechada à esquerda e à direita	01
01	44	Advertência de curva fechada à esquerda e à direita	01
01	45	Advertência de curva fechada à esquerda e à direita	01
01	46	Advertência de curva fechada à esquerda e à direita	01
01	47	Advertência de curva fechada à esquerda e à direita	01
01	48	Advertência de curva fechada à esquerda e à direita	01
01	49	Advertência de curva fechada à esquerda e à direita	01
01	50	Advertência de curva fechada à esquerda e à direita	01

PLACAS DE ADVERTÊNCIA

PLACAS	CÓDIGO	DESCRIÇÃO (m)	QUANTIDADE (un)
	01	Advertência de curva à esquerda	01
	02	Advertência de curva à direita	01
	03	Advertência de curva a esquerda e a direita	01

As Placas de Advertência são de seguintes características:

- Material - Alumínio
- Coleção - 0200
- Coleção - 0201
- Coleção - 0202
- Coleção - 0203
- Coleção - 0204
- Coleção - 0205
- Coleção - 0206
- Coleção - 0207
- Coleção - 0208
- Coleção - 0209
- Coleção - 0210
- Coleção - 0211
- Coleção - 0212
- Coleção - 0213
- Coleção - 0214
- Coleção - 0215
- Coleção - 0216
- Coleção - 0217
- Coleção - 0218
- Coleção - 0219
- Coleção - 0220
- Coleção - 0221
- Coleção - 0222
- Coleção - 0223
- Coleção - 0224
- Coleção - 0225
- Coleção - 0226
- Coleção - 0227
- Coleção - 0228
- Coleção - 0229
- Coleção - 0230
- Coleção - 0231
- Coleção - 0232
- Coleção - 0233
- Coleção - 0234
- Coleção - 0235
- Coleção - 0236
- Coleção - 0237
- Coleção - 0238
- Coleção - 0239
- Coleção - 0240
- Coleção - 0241
- Coleção - 0242
- Coleção - 0243
- Coleção - 0244
- Coleção - 0245
- Coleção - 0246
- Coleção - 0247
- Coleção - 0248
- Coleção - 0249
- Coleção - 0250



PRATICIDADE MUNICIPAL DE GUARACABA DO NORTE

RECUPERAÇÃO DE ESTRADAS VICINAIS NO MUNICÍPIO DE GUARACABA DO NORTE-CE - PT 1386270-03

SINALIZAÇÃO VIÁRIA

PROPOSTA: 1386270-03

VALOR: R\$ 1.000,00

4 / 04

SEM SE

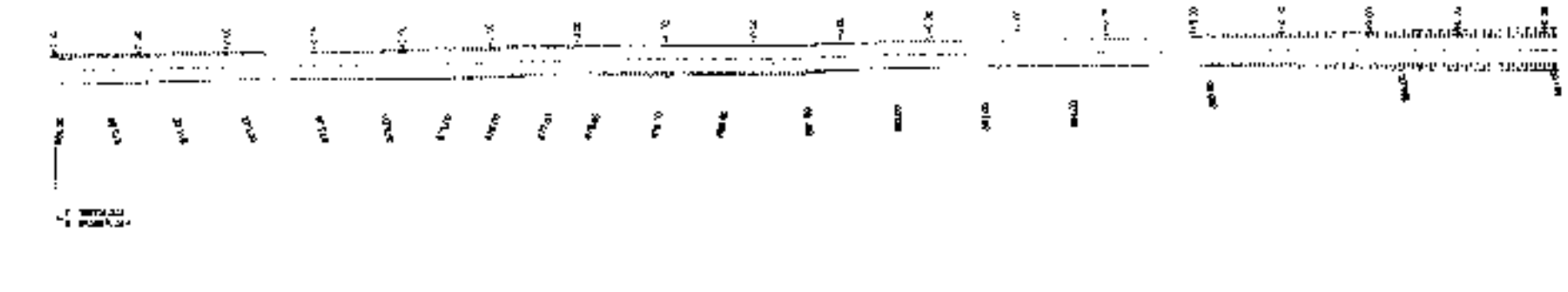

0 100 200 300 400

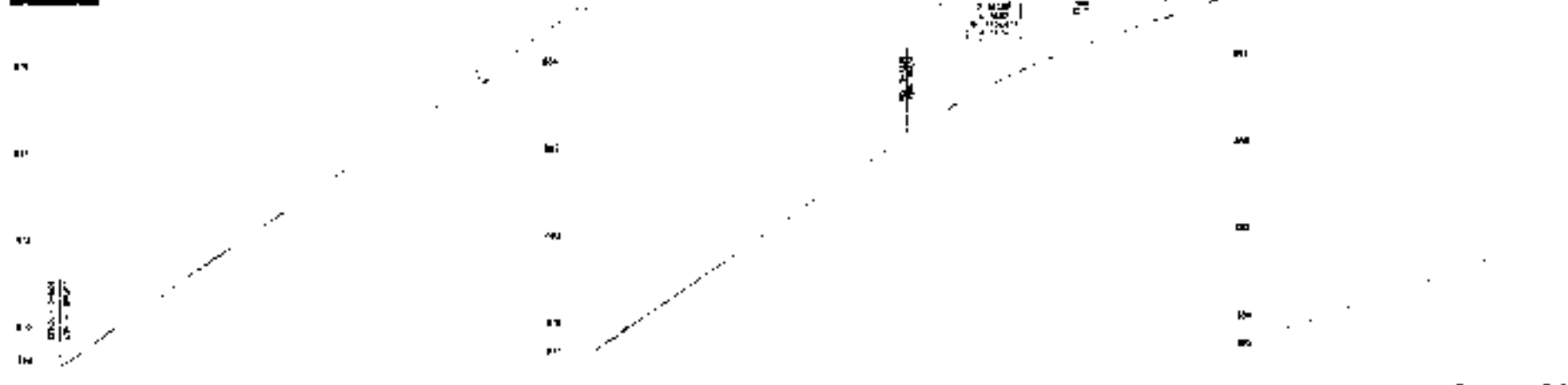

0+00	0+20	0+40	0+60	0+80	0+90	0+95	0+98	0+99	1+00
14,00	15,00	16,00	17,00	18,00	19,00	20,00	21,00	22,00	23,00

SOLUÇÕES	PROJEÇÃO	LIMITE	SINCRON	TR. ALL	AT. PAV	L. DEP	L. DE AC. DE ANG

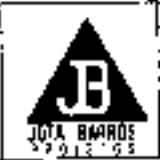

PREFEITURA MUNICIPAL DE GUARACIABA DO NORTE
 RECUPERAÇÃO DE ESTRADAS VICINAIS NO ALCIBIRIO DE GUARACIABA DO NORTE-CE - P1 1086270-03
ESTAQUEAMENTO E PERFIL LONGITUDINAL
 PROJETO: ANTONIO CARLOS MORAES DE SOUZA JUNIOR
 DATA: 15/05/2014



1104
 DATA: 15/05/2014
 HORA: 14:57:02

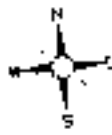

0 1000 2000

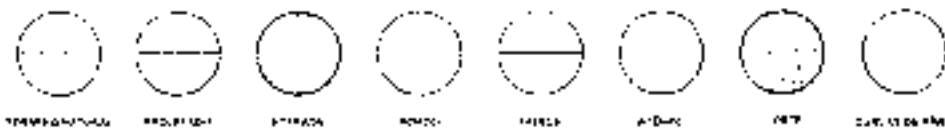
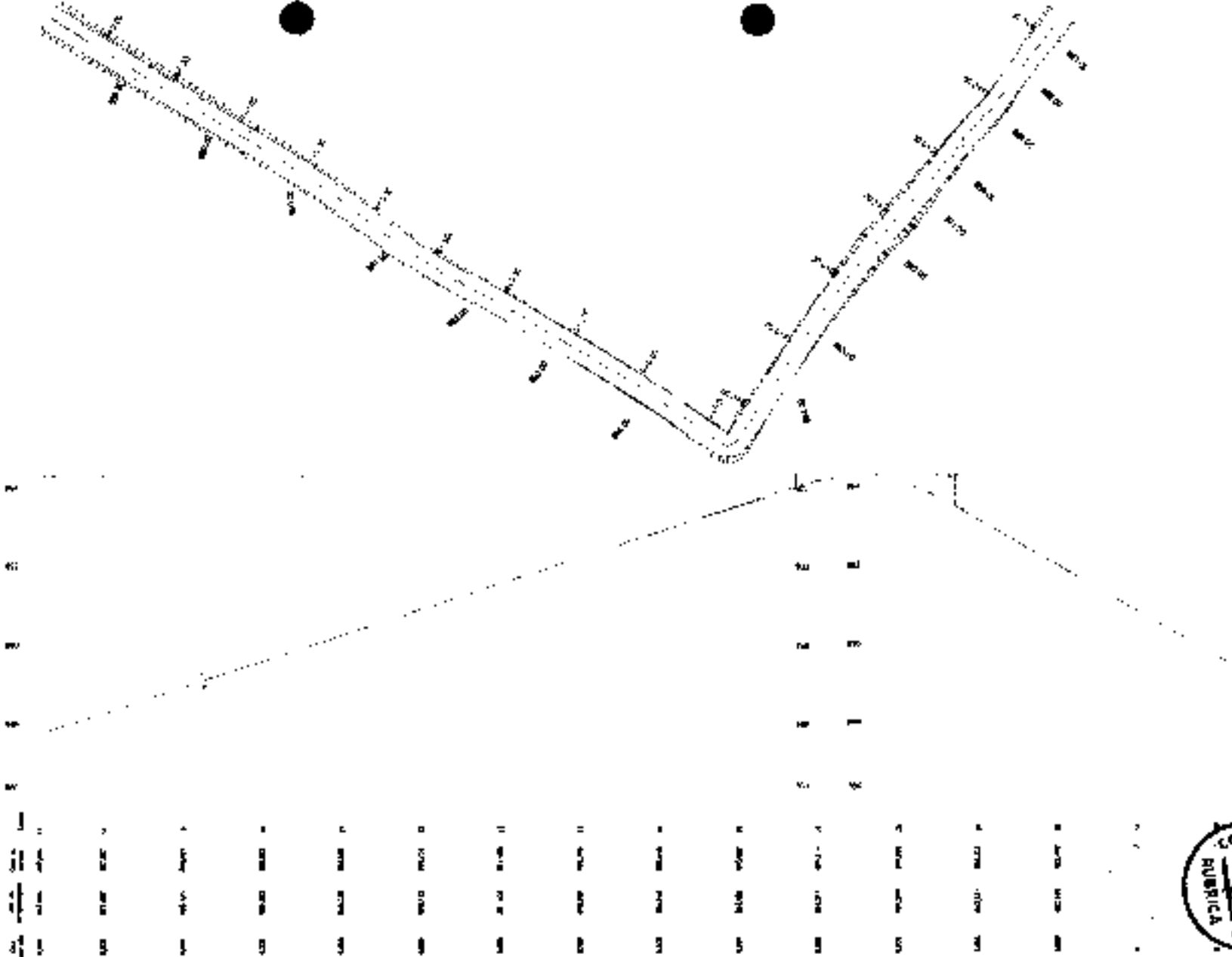

PREFEITURA MUNICIPAL DE GUARAJUBÁ DO NORTE RECUPERAÇÃO DE ESTRADAS VICINAIS NO MUNICÍPIO DE GUARAJUBÁ DO NORTE-CE - PT 10852/0-02 ESTAQUEAMENTO E PERFIL LONGITUDINAL		2 / 04 Escala: 1:1000 Data: 11/11/2011
PROJETO:	ENG. CEL. VILTON MOREIRA FERREIRA - LÍDER ORÇAMENTAL	
PROJ. CIVIL:	PAULA DEFRANCO JUNIOR ENG. FIDELMÁRIO	



1:200 2000

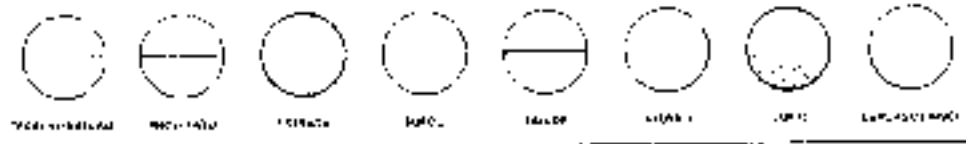
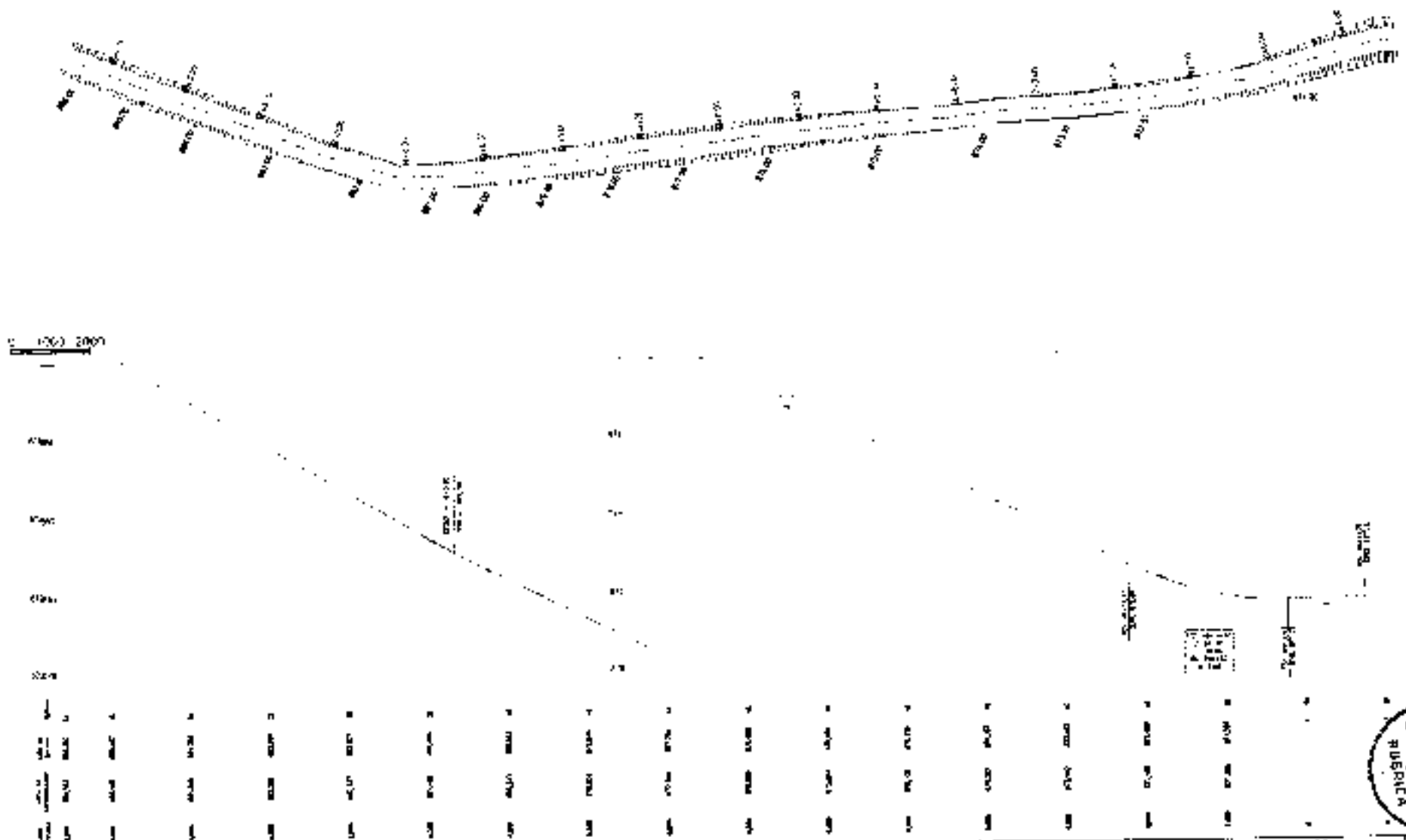

 <p>JOTA BARROS Engenharia e Projetos</p>	<p>PREFEITURA MUNICIPAL DE GUARACIABA DO NORTE</p>		<p>3 / 04</p>
	<p>RECUPERAÇÃO DE ESTRADAS RURAIS NO MUNICÍPIO DE GUARACIABA DO NORTE- RN - PI 139627002</p>		
	<p>ESTAQUEAMENTO E PERFIL LONGITUDINAL</p>		
<p>PROJETO</p>	<p>ENG.º CARLOS EDUARDO DE LIMA FERREIRA</p>		<p>DATA</p>
<p>PLANO</p>	<p>PLANO DE ESTACIONAMENTO E PERFIL LONGITUDINAL</p>		<p>1 / 2017</p>



1:1000

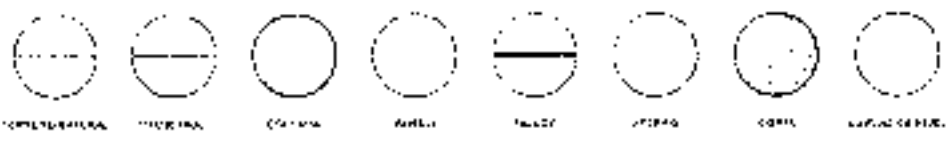
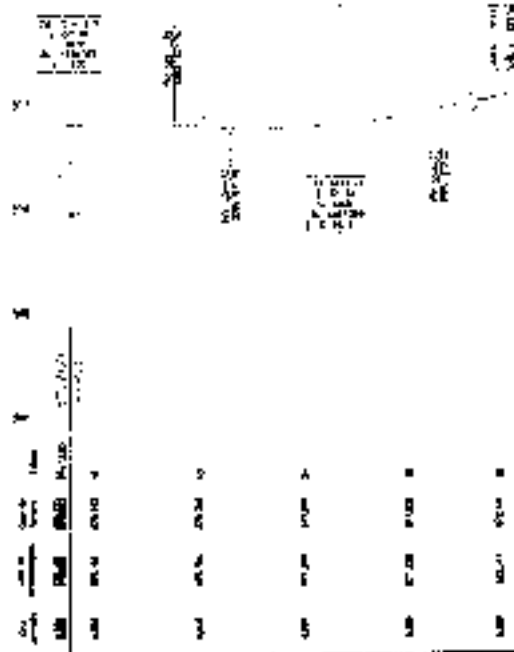
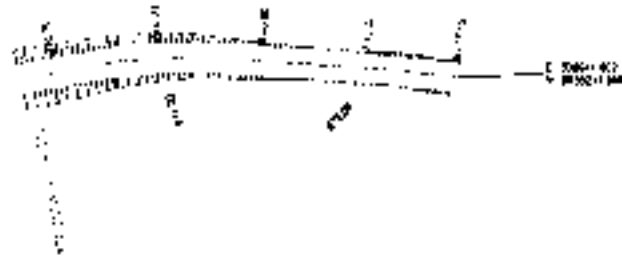

PREFEITURA MUNICIPAL DE GUARACIABA DO NORTE		4 / 04
RECUPERAÇÃO DE ESTRADAS VICINAIS NO MUNICÍPIO DE GUARACIABA DO NORTE - CE - FT 10882/0-03		
ESTAQUEAMENTO E PERFIL LONGITUDINAL		
PROJETA	DNE ENR 010882/0-03	1 / 10/17
PROJETO	FRANCISCO DE ASSIS ALVES PEREIRA	1 / 10/17

Item	Descrição	Quantidade	Valor Unitário	Valor Total
001
002
003
004
005
006
007
008
009
010
011
012
013
014
015
016
017
018
019
020
021
022
023
024
025
026
027
028
029
030
031
032
033
034
035
036
037
038
039
040
041
042
043
044
045
046
047
048
049
050
051
052
053
054
055
056
057
058
059
060
061
062
063
064
065
066
067
068
069
070
071
072
073
074
075
076
077
078
079
080
081
082
083
084
085
086
087
088
089
090
091
092
093
094
095
096
097
098
099
100

LEGENDA

ATERRO

CORTE



PREFEITURA MUNICIPAL DE GUARACIABA DO NORTE

RECUPERAÇÃO DE ESTRADAS VICIAIS DO MUNICÍPIO DE GUARACIABA DO NORTE - PE 1088770-01

SEÇÃO FRAQUELHAS



AV. ...

1105

1250



LEGENDA



-  ATERRO
-  CORTE

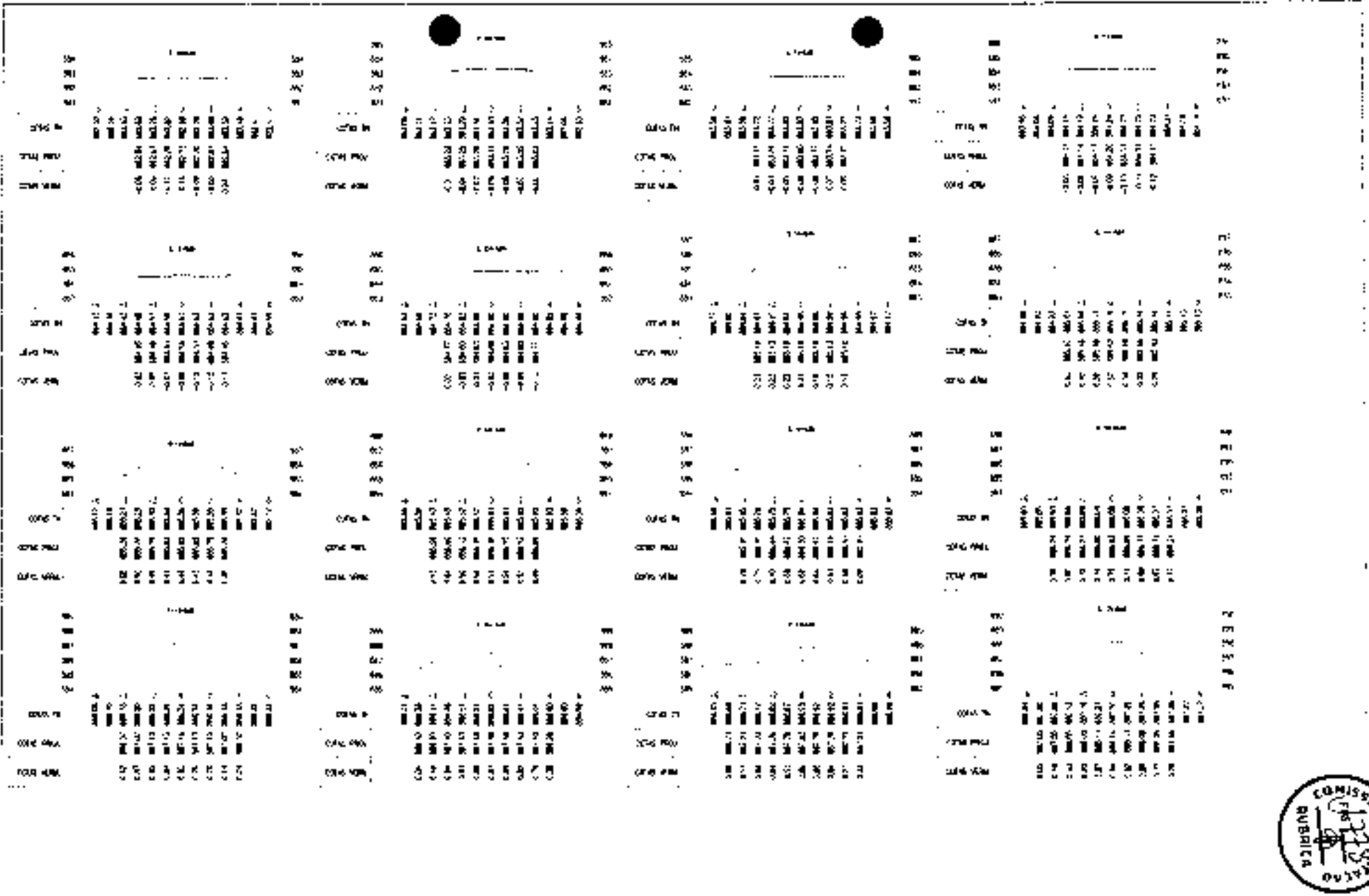

PREFEITURA MUNICIPAL DE GUARACIABA DO NORTE RECUPERAÇÃO DE ESTRADAS VICINAIS NO MUNICÍPIO DE GUARACIABA DO NORTE-DE - PT 1685270/01 SEÇÕES TRANSVERSAIS		DATA: 2 / 10 / 2017 FOLHA: 128
PROPOSTA Nº: 002/2017 VALOR: R\$ 1.200.000,00	END: RUA PRINCIPAL, QUADRA 01, LOTE 01 - JARDIM SÃO CARLOS - GUARACIABA DO NORTE - RN CEP: 59.100-000	



LEGENDA

-  ATERRO
-  CALÇADA





PREFEITURA MUNICIPAL DE GUARACIABA DO NORTE
 RECONSTRUÇÃO DE ESTRADAS VICINAIS NO MUNICÍPIO DE GUARACIABA
 COM ROTEIRO - PT 1056270-03
 SEÇÕES TRANSVERSAIS

CONTERÇA: PAVIMENTO DE CIMENTO PORTLAND
 PROJETO: PAVIMENTO DE CIMENTO PORTLAND

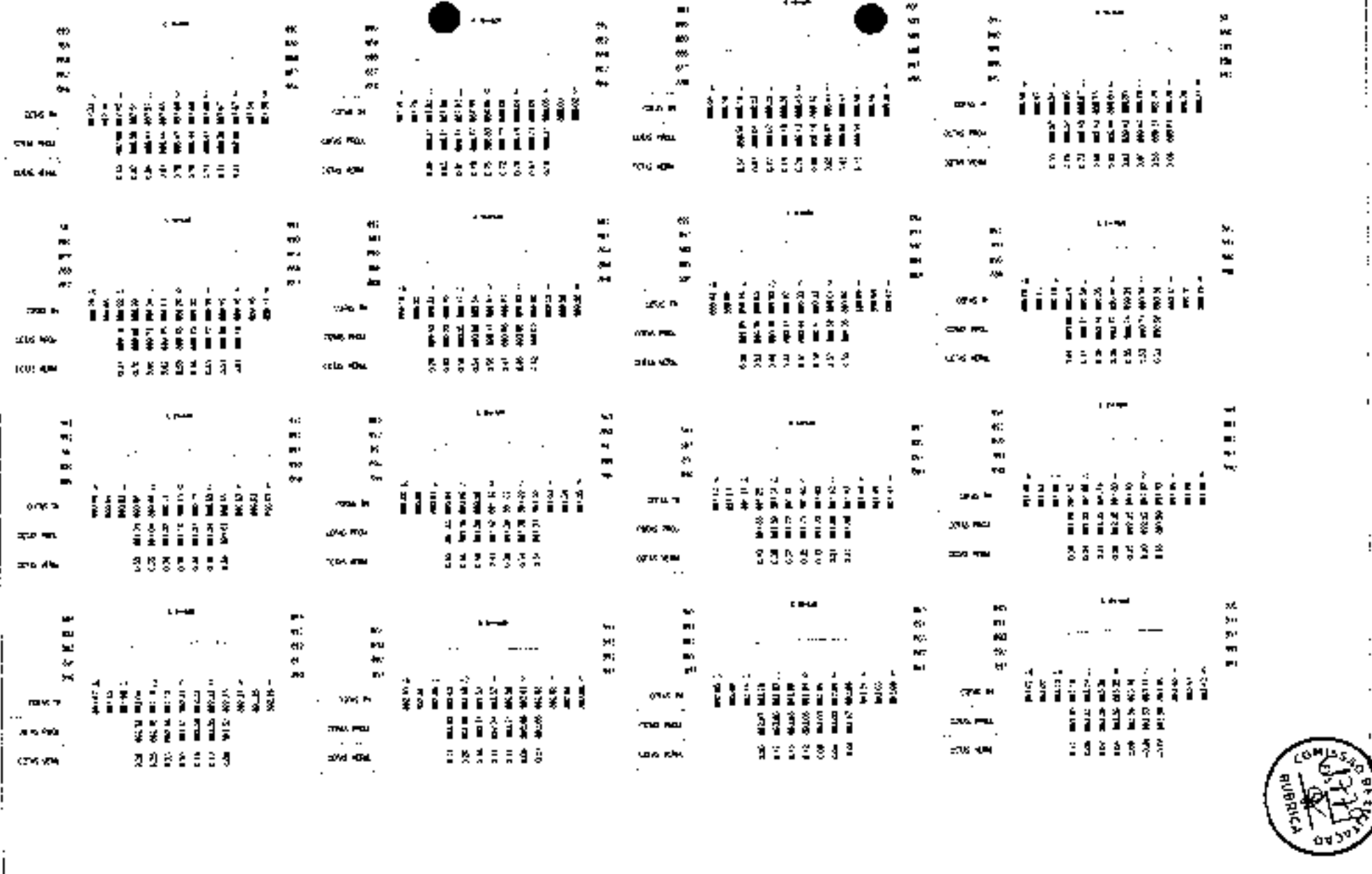
3 / 07
 1056



LEGENDA

-  ATENHO
-  CORTE

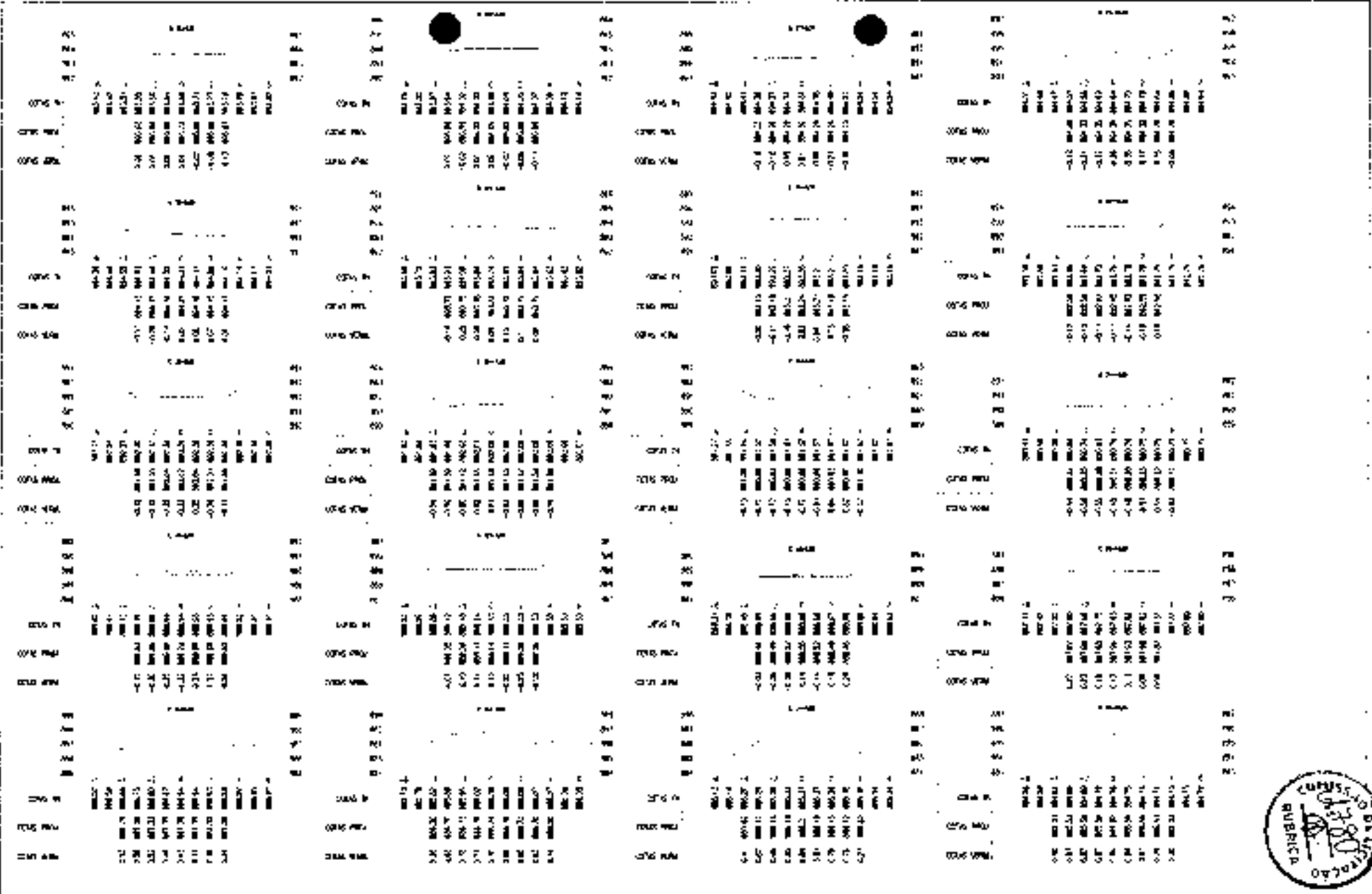

PREFEITURA MUNICIPAL DE GUARARÃ DO NORTE
 RECUPERAÇÃO DE ESTADAS VICINAIS AO MUNICÍPIO DE GUARARÃ DO NORTE-CE - P1 1066270-03
 SEÇÕES TRANSVERSAIS

PROJETO: RUA DA SERRA NEGRA TORQUATO, M. MUNICIPAL
 ARQUITETO: RAFAEL AUGUSTO DE MOURA FERREIRA COSTA

4 / 07
 1994





<p>JOTA BARROS PROJECTS</p>	PREFEITURA MUNICIPAL DE GUARACIABA DO NORTE RECUPERAÇÃO DE ESTRADAS VICINAIS NO MUNICÍPIO DE GUARACIABA DO NORTE-CE - ET 1088/20-03 SEÇÕES TRANSVERSAIS B		Página nº 5 / 07
	PROPOSTA Nº 001/2018	VALOR DA OBRAS R\$ 1.000.000,00	
	DATA 15/03/2018	LOCAL DA OBRAS RUA 1088/20-03	

ITEM	DESCRIÇÃO	UNID.	QUANT.	VALOR UNIT.	VALOR TOTAL
1	1088/20-03	m	100	10000,00	1000000,00
2	1088/20-03	m	100	10000,00	1000000,00
3	1088/20-03	m	100	10000,00	1000000,00
4	1088/20-03	m	100	10000,00	1000000,00
5	1088/20-03	m	100	10000,00	1000000,00
6	1088/20-03	m	100	10000,00	1000000,00
7	1088/20-03	m	100	10000,00	1000000,00
8	1088/20-03	m	100	10000,00	1000000,00
9	1088/20-03	m	100	10000,00	1000000,00
10	1088/20-03	m	100	10000,00	1000000,00
11	1088/20-03	m	100	10000,00	1000000,00
12	1088/20-03	m	100	10000,00	1000000,00
13	1088/20-03	m	100	10000,00	1000000,00
14	1088/20-03	m	100	10000,00	1000000,00
15	1088/20-03	m	100	10000,00	1000000,00
16	1088/20-03	m	100	10000,00	1000000,00
17	1088/20-03	m	100	10000,00	1000000,00
18	1088/20-03	m	100	10000,00	1000000,00
19	1088/20-03	m	100	10000,00	1000000,00
20	1088/20-03	m	100	10000,00	1000000,00
21	1088/20-03	m	100	10000,00	1000000,00
22	1088/20-03	m	100	10000,00	1000000,00
23	1088/20-03	m	100	10000,00	1000000,00
24	1088/20-03	m	100	10000,00	1000000,00
25	1088/20-03	m	100	10000,00	1000000,00
26	1088/20-03	m	100	10000,00	1000000,00
27	1088/20-03	m	100	10000,00	1000000,00
28	1088/20-03	m	100	10000,00	1000000,00
29	1088/20-03	m	100	10000,00	1000000,00
30	1088/20-03	m	100	10000,00	1000000,00
31	1088/20-03	m	100	10000,00	1000000,00
32	1088/20-03	m	100	10000,00	1000000,00
33	1088/20-03	m	100	10000,00	1000000,00
34	1088/20-03	m	100	10000,00	1000000,00
35	1088/20-03	m	100	10000,00	1000000,00
36	1088/20-03	m	100	10000,00	1000000,00
37	1088/20-03	m	100	10000,00	1000000,00
38	1088/20-03	m	100	10000,00	1000000,00
39	1088/20-03	m	100	10000,00	1000000,00
40	1088/20-03	m	100	10000,00	1000000,00
41	1088/20-03	m	100	10000,00	1000000,00
42	1088/20-03	m	100	10000,00	1000000,00
43	1088/20-03	m	100	10000,00	1000000,00
44	1088/20-03	m	100	10000,00	1000000,00
45	1088/20-03	m	100	10000,00	1000000,00
46	1088/20-03	m	100	10000,00	1000000,00
47	1088/20-03	m	100	10000,00	1000000,00
48	1088/20-03	m	100	10000,00	1000000,00
49	1088/20-03	m	100	10000,00	1000000,00
50	1088/20-03	m	100	10000,00	1000000,00
51	1088/20-03	m	100	10000,00	1000000,00
52	1088/20-03	m	100	10000,00	1000000,00
53	1088/20-03	m	100	10000,00	1000000,00
54	1088/20-03	m	100	10000,00	1000000,00
55	1088/20-03	m	100	10000,00	1000000,00
56	1088/20-03	m	100	10000,00	1000000,00
57	1088/20-03	m	100	10000,00	1000000,00
58	1088/20-03	m	100	10000,00	1000000,00
59	1088/20-03	m	100	10000,00	1000000,00
60	1088/20-03	m	100	10000,00	1000000,00
61	1088/20-03	m	100	10000,00	1000000,00
62	1088/20-03	m	100	10000,00	1000000,00
63	1088/20-03	m	100	10000,00	1000000,00
64	1088/20-03	m	100	10000,00	1000000,00
65	1088/20-03	m	100	10000,00	1000000,00
66	1088/20-03	m	100	10000,00	1000000,00
67	1088/20-03	m	100	10000,00	1000000,00
68	1088/20-03	m	100	10000,00	1000000,00
69	1088/20-03	m	100	10000,00	1000000,00
70	1088/20-03	m	100	10000,00	1000000,00
71	1088/20-03	m	100	10000,00	1000000,00
72	1088/20-03	m	100	10000,00	1000000,00
73	1088/20-03	m	100	10000,00	1000000,00
74	1088/20-03	m	100	10000,00	1000000,00
75	1088/20-03	m	100	10000,00	1000000,00
76	1088/20-03	m	100	10000,00	1000000,00
77	1088/20-03	m	100	10000,00	1000000,00
78	1088/20-03	m	100	10000,00	1000000,00
79	1088/20-03	m	100	10000,00	1000000,00
80	1088/20-03	m	100	10000,00	1000000,00
81	1088/20-03	m	100	10000,00	1000000,00
82	1088/20-03	m	100	10000,00	1000000,00
83	1088/20-03	m	100	10000,00	1000000,00
84	1088/20-03	m	100	10000,00	1000000,00
85	1088/20-03	m	100	10000,00	1000000,00
86	1088/20-03	m	100	10000,00	1000000,00
87	1088/20-03	m	100	10000,00	1000000,00
88	1088/20-03	m	100	10000,00	1000000,00
89	1088/20-03	m	100	10000,00	1000000,00
90	1088/20-03	m	100	10000,00	1000000,00
91	1088/20-03	m	100	10000,00	1000000,00
92	1088/20-03	m	100	10000,00	1000000,00
93	1088/20-03	m	100	10000,00	1000000,00
94	1088/20-03	m	100	10000,00	1000000,00
95	1088/20-03	m	100	10000,00	1000000,00
96	1088/20-03	m	100	10000,00	1000000,00
97	1088/20-03	m	100	10000,00	1000000,00
98	1088/20-03	m	100	10000,00	1000000,00
99	1088/20-03	m	100	10000,00	1000000,00
100	1088/20-03	m	100	10000,00	1000000,00

RECEBIDA
 DATA
 LOCAL

Item	Descrição	Quantidade	Valor Unitário	Valor Total
01
02
03
04
05
06
07
08
09
10
11
12
13
14
15
16
17
18
19
20
21
22
23
24
25
26
27
28
29
30
31
32
33
34
35
36
37
38
39
40
41
42
43
44
45
46
47
48
49
50
51
52
53
54
55
56
57
58
59
60
61
62
63
64
65
66
67
68
69
70
71
72
73
74
75
76
77
78
79
80
81
82
83
84
85
86
87
88
89
90
91
92
93
94
95
96
97
98
99
100

LEGENDA

ATERRO

CORTE



PREFEITURA MUNICIPAL DE JARAGUÁ DO NORTE

RECURSOS DE ESTIMOS VINCULADOS NO MUNICÍPIO DE JARAGUÁ DO NORTE



CONCÓRDE DE ESTIMOS

SEÇÕES TRANSVERSAIS

6 / 07

1999

LEGENDA

-  ALIENADO
-  CORTES

1 2 3 4 5 6 7 8 9 10 11 12 13 14 15 16 17 18 19 20 21 22 23 24 25 26 27 28 29 30 31 32 33 34 35 36 37 38 39 40 41 42 43 44 45 46 47 48 49 50 51 52 53 54 55 56 57 58 59 60 61 62 63 64 65 66 67 68 69 70 71 72 73 74 75 76 77 78 79 80 81 82 83 84 85 86 87 88 89 90 91 92 93 94 95 96 97 98 99 100

100 101 102 103 104 105 106 107 108 109 110 111 112 113 114 115 116 117 118 119 120 121 122 123 124 125 126 127 128 129 130 131 132 133 134 135 136 137 138 139 140 141 142 143 144 145 146 147 148 149 150 151 152 153 154 155 156 157 158 159 160 161 162 163 164 165 166 167 168 169 170 171 172 173 174 175 176 177 178 179 180 181 182 183 184 185 186 187 188 189 190 191 192 193 194 195 196 197 198 199 200

200 201 202 203 204 205 206 207 208 209 210 211 212 213 214 215 216 217 218 219 220 221 222 223 224 225 226 227 228 229 230 231 232 233 234 235 236 237 238 239 240 241 242 243 244 245 246 247 248 249 250 251 252 253 254 255 256 257 258 259 260 261 262 263 264 265 266 267 268 269 270 271 272 273 274 275 276 277 278 279 280 281 282 283 284 285 286 287 288 289 290 291 292 293 294 295 296 297 298 299 300

300 301 302 303 304 305 306 307 308 309 310 311 312 313 314 315 316 317 318 319 320 321 322 323 324 325 326 327 328 329 330 331 332 333 334 335 336 337 338 339 340 341 342 343 344 345 346 347 348 349 350 351 352 353 354 355 356 357 358 359 360 361 362 363 364 365 366 367 368 369 370 371 372 373 374 375 376 377 378 379 380 381 382 383 384 385 386 387 388 389 390 391 392 393 394 395 396 397 398 399 400

400 401 402 403 404 405 406 407 408 409 410 411 412 413 414 415 416 417 418 419 420 421 422 423 424 425 426 427 428 429 430 431 432 433 434 435 436 437 438 439 440 441 442 443 444 445 446 447 448 449 450 451 452 453 454 455 456 457 458 459 460 461 462 463 464 465 466 467 468 469 470 471 472 473 474 475 476 477 478 479 480 481 482 483 484 485 486 487 488 489 490 491 492 493 494 495 496 497 498 499 500

500 501 502 503 504 505 506 507 508 509 510 511 512 513 514 515 516 517 518 519 520 521 522 523 524 525 526 527 528 529 530 531 532 533 534 535 536 537 538 539 540 541 542 543 544 545 546 547 548 549 550 551 552 553 554 555 556 557 558 559 560 561 562 563 564 565 566 567 568 569 570 571 572 573 574 575 576 577 578 579 580 581 582 583 584 585 586 587 588 589 590 591 592 593 594 595 596 597 598 599 600

600 601 602 603 604 605 606 607 608 609 610 611 612 613 614 615 616 617 618 619 620 621 622 623 624 625 626 627 628 629 630 631 632 633 634 635 636 637 638 639 640 641 642 643 644 645 646 647 648 649 650 651 652 653 654 655 656 657 658 659 660 661 662 663 664 665 666 667 668 669 670 671 672 673 674 675 676 677 678 679 680 681 682 683 684 685 686 687 688 689 690 691 692 693 694 695 696 697 698 699 700

700 701 702 703 704 705 706 707 708 709 710 711 712 713 714 715 716 717 718 719 720 721 722 723 724 725 726 727 728 729 730 731 732 733 734 735 736 737 738 739 740 741 742 743 744 745 746 747 748 749 750 751 752 753 754 755 756 757 758 759 760 761 762 763 764 765 766 767 768 769 770 771 772 773 774 775 776 777 778 779 780 781 782 783 784 785 786 787 788 789 790 791 792 793 794 795 796 797 798 799 800

800 801 802 803 804 805 806 807 808 809 810 811 812 813 814 815 816 817 818 819 820 821 822 823 824 825 826 827 828 829 830 831 832 833 834 835 836 837 838 839 840 841 842 843 844 845 846 847 848 849 850 851 852 853 854 855 856 857 858 859 860 861 862 863 864 865 866 867 868 869 870 871 872 873 874 875 876 877 878 879 880 881 882 883 884 885 886 887 888 889 890 891 892 893 894 895 896 897 898 899 900



PREFEITURA MUNICIPAL DE GUARACIABA DO NORTE
 RECONSTRUÇÃO DE ESTRADAS VICINAIS NO MUNICÍPIO DE GUARACIABA DO NORTE-CE - Nº 10852/0-05
 SEÇÕES TRANSVERSAIS

7 10
 1050





1:500 2000

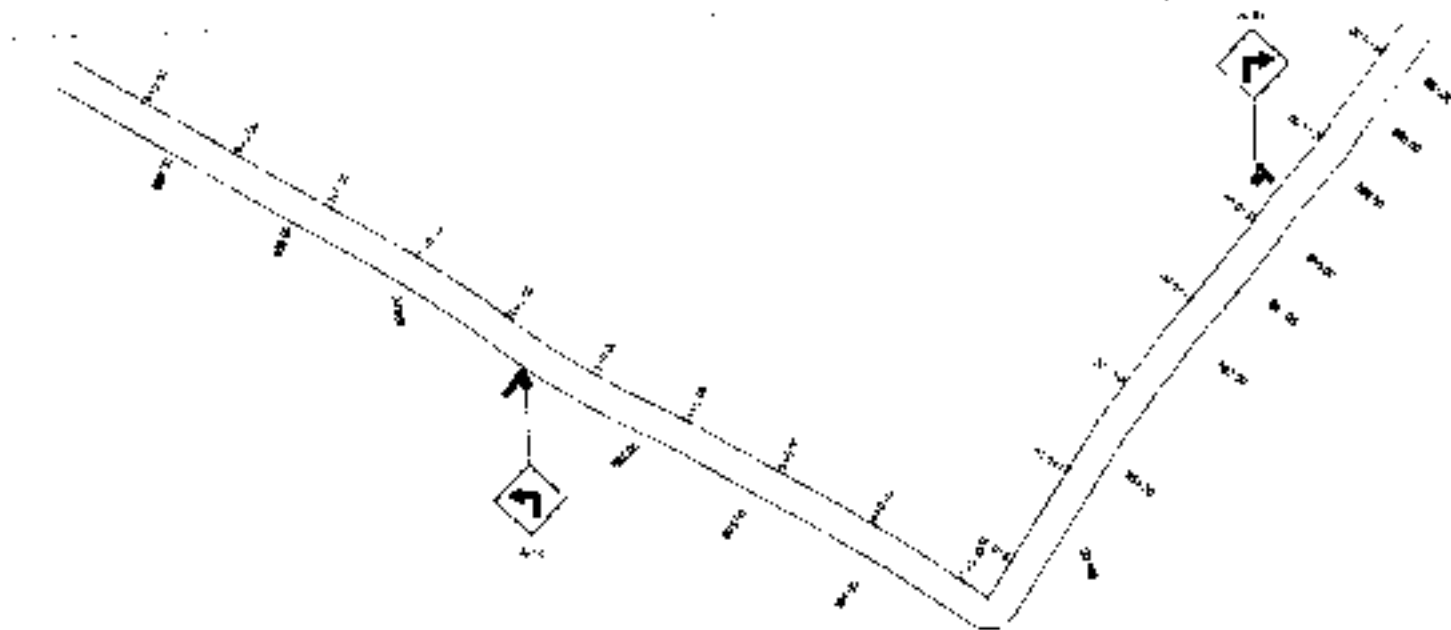

1:500 2000



PREFEITURA MUNICIPAL DE GUARACIABA DO NORTE	
RECUPERAÇÃO DE ESTRADAS VICINAIS NO MUNICÍPIO DE GUARACIABA DO NORTE - CE - PT 1386274-03	
BINALIZAÇÃO VIÁRIA	
PROPOSTA Nº	0001/2014
EMPRESA	JOÃO BARROS ENGENHEIRO
ENDEREÇO	AV. PAMPLONA, 1000 - JARDIM SÃO JOÃO - GUARACIABA DO NORTE - CE

1 / 03
11/000

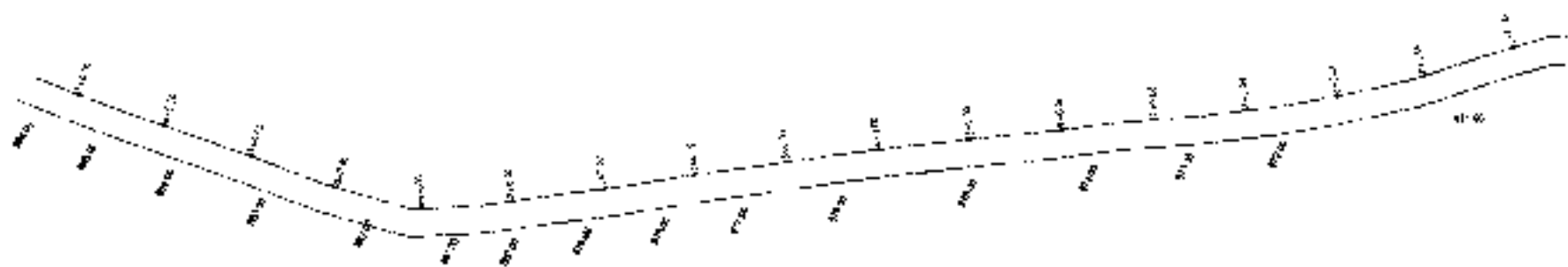

1:1000 2000

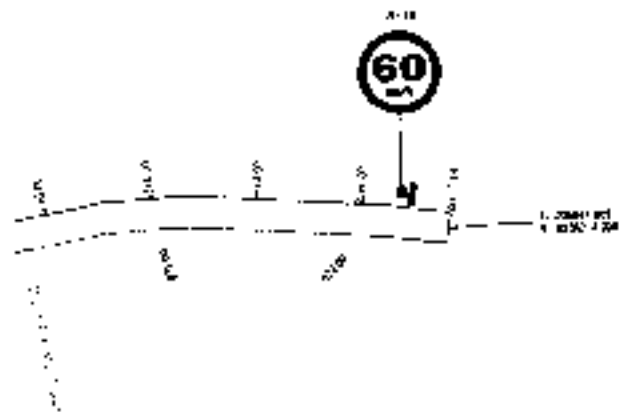

1:1000 2000



PREFEITURA MUNICIPAL DE GUARACIABA DO NORTE		218
RECUPERAÇÃO DE ESTRADAS VICINAIS NO MUNICÍPIO DE GUARACIABA DO NORTE-CE - PT 1086270-03		1:2000
SINALIZAÇÃO VIÁRIA		
PROJETO	ENR. C. M. ALVARO MOREIRA TORRES - ENR. M. D. L.	
REVISÃO	ENR. T. M. ENR. P. M. ENR. P. M. ENR. P. M.	

Paralelismo transversal

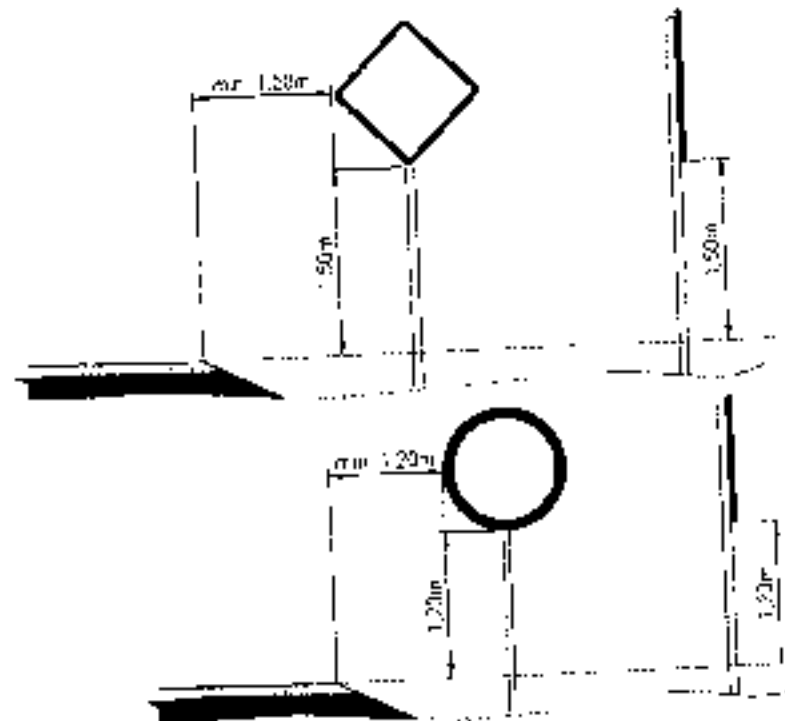

PLACAS DE ADVERTÊNCIA

PLACAS	DÉCIMO	QUANTIDADE	VALOR UNITÁRIO	TOTAL
	10	1	100,00	100,00
	10	1	100,00	100,00

PLACAS DE ADVERTÊNCIA

PLACAS	QUANTIDADE	VALOR UNITÁRIO	TOTAL
	1	100,00	100,00

As Placas de Advertência tem as seguintes características:

Material	Cor	Tamanho	Forma
Alumínio	Branco	40x40cm	Quadrado
Alumínio	Branco	40x40cm	Quadrado
Alumínio	Branco	40x40cm	Quadrado
Alumínio	Branco	40x40cm	Quadrado

As Placas de Advertência tem as seguintes características:

Material	Cor	Tamanho	Forma
Alumínio	Branco	40x40cm	Quadrado
Alumínio	Branco	40x40cm	Quadrado
Alumínio	Branco	40x40cm	Quadrado
Alumínio	Branco	40x40cm	Quadrado



PREFEITURA MUNICIPAL DE GUARACIABA DO NORTE
 RECUPERAÇÃO DE ESTRADAS VICINAIS NO MUNICÍPIO DE GUARACIABA DO NORTE-CE - R.T. 1004070-03
 BINALIZAÇÃO VIÁRIA

VALOR UNITÁRIO: R\$ 100,00
 VALOR TOTAL: R\$ 300,00

3 / 03
 14/03



2000

0 1000 2000

0
2
4
6
8
10
12
14



CANALIZADA



ESTRADA



TERRENO



VAZIO



VAZIO



ESTRADA



TERRENO



ESTRADA



PREFEITURA MUNICIPAL DE GUARACIABA DO NORTE	
RECUPERAÇÃO DE ESTRADAS VICINAIS NO MUNICÍPIO DE GUARACIABA DO NORTE-DE - FT 10002/0003	
ESTAQUEAMENTO E PERFIL LONGITUDINAL	
1:1	PROJETO DE RECUPERAÇÃO DE ESTRADAS VICINAIS
1:1	GUARACIABA DO NORTE, RS, 2010

1 / 08
Escala
H 1:1000
V 1:100

100m



0 2000 4000

0 1000 2000

0	200	400	600	800	1000	1200	1400
10	10	10	10	10	10	10	10
10	10	10	10	10	10	10	10
10	10	10	10	10	10	10	10



0 1000 2000

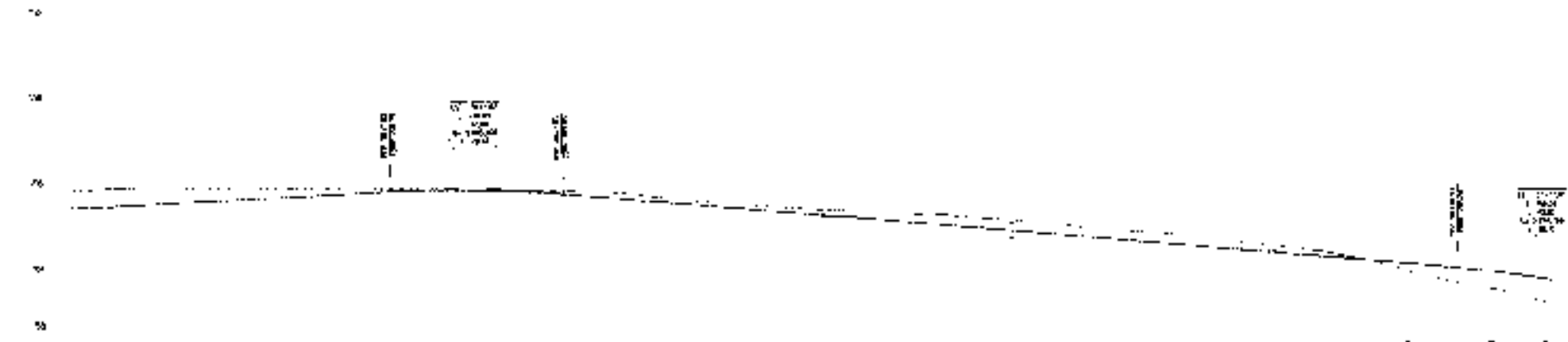

Estaca	100+00	100+10	100+20	100+30	100+40	100+50	100+60	100+70	100+80	100+90	100+00	100+10	100+20	100+30	100+40	100+50	100+60	100+70	100+80	100+90	100+00	
Alt. Ex.	10.00	10.00	10.00	10.00	10.00	10.00	10.00	10.00	10.00	10.00	10.00	10.00	10.00	10.00	10.00	10.00	10.00	10.00	10.00	10.00	10.00	10.00
Alt. Proj.	10.00	10.00	10.00	10.00	10.00	10.00	10.00	10.00	10.00	10.00	10.00	10.00	10.00	10.00	10.00	10.00	10.00	10.00	10.00	10.00	10.00	10.00
Alt. Proj. (m)	10.00	10.00	10.00	10.00	10.00	10.00	10.00	10.00	10.00	10.00	10.00	10.00	10.00	10.00	10.00	10.00	10.00	10.00	10.00	10.00	10.00	10.00

TRILÍNEA	BULEVAR	ESTRADA	RUA	AV. DE 20M	AV. DE 30M	AV. DE 40M	AV. DE 50M



PREFEITURA MUNICIPAL DE GUARACIABA DO NORTE

RECUPERAÇÃO DE ESTRADAS VICINAIS NO MUNICÍPIO DE GUARACIABA DO NORTE - CE - PT 1086270-00

ESTAQUEAMENTO E PERFIL LONGITUDINAL

PROJ. CIVIL, ELAB. POR JOÃO BARROS PROJETOS

PROJ. EXEC. POR JOÃO BARROS PROJETOS

2 / 08

ESCALA: H=1:1000 V=1:100

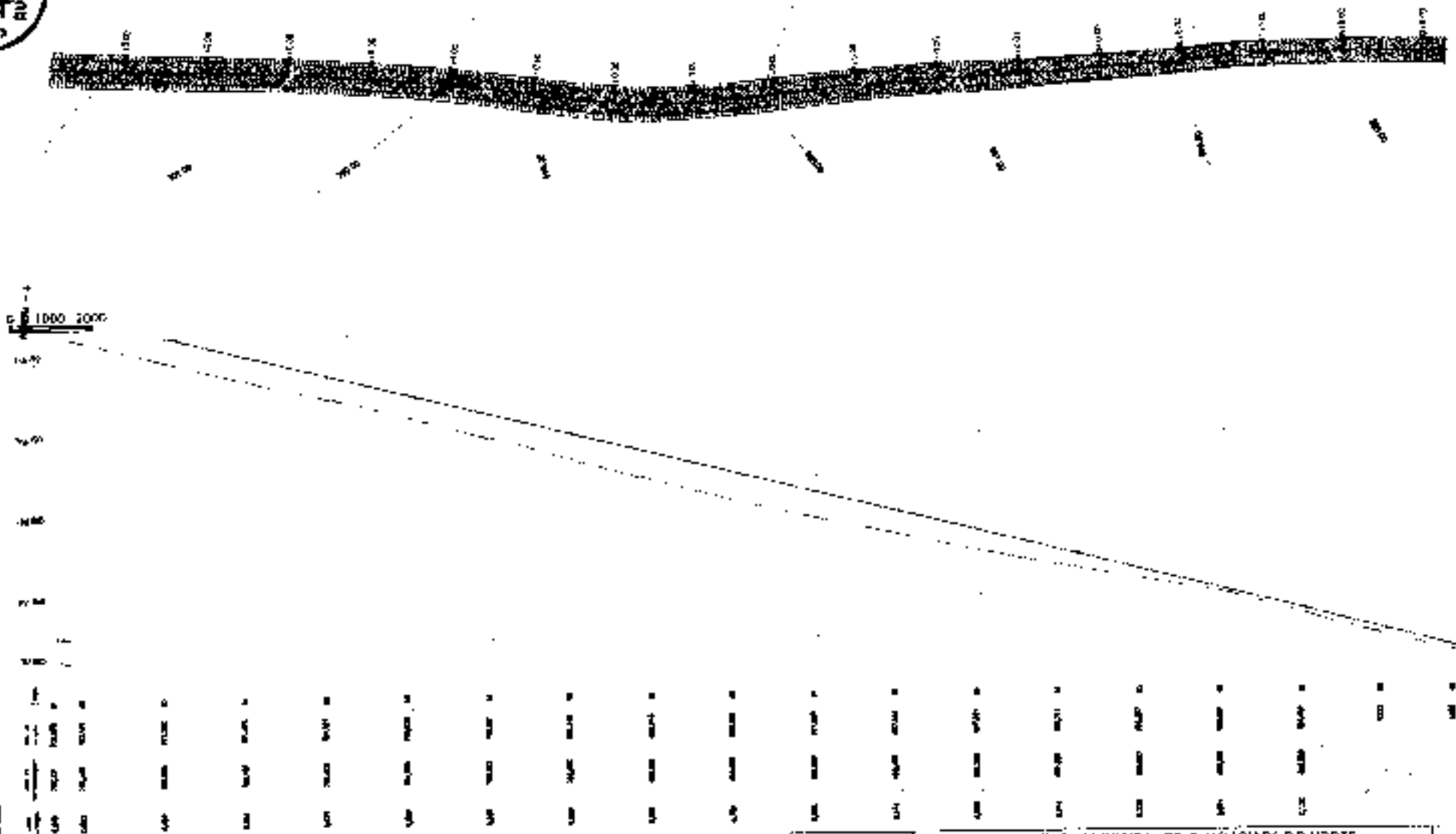

1:1000 2000

1	2	3	4	5	6	7	8	9	10	11	12	13	14	15	16	17	18	19	20	21	22	23	24	25	26	27	28	29	30	31	32	33	34	35	36	37	38	39	40	41	42	43	44	45	46	47	48	49	50	51	52	53	54	55	56	57	58	59	60	61	62	63	64	65	66	67	68	69	70	71	72	73	74	75	76	77	78	79	80	81	82	83	84	85	86	87	88	89	90	91	92	93	94	95	96	97	98	99	100
---	---	---	---	---	---	---	---	---	----	----	----	----	----	----	----	----	----	----	----	----	----	----	----	----	----	----	----	----	----	----	----	----	----	----	----	----	----	----	----	----	----	----	----	----	----	----	----	----	----	----	----	----	----	----	----	----	----	----	----	----	----	----	----	----	----	----	----	----	----	----	----	----	----	----	----	----	----	----	----	----	----	----	----	----	----	----	----	----	----	----	----	----	----	----	----	----	----	----	-----

ASfalto	Asfalto	Asfalto	Asfalto	Asfalto	Asfalto	Asfalto	Asfalto	Asfalto



PREFEITURA MUNICIPAL DE GUARACIABA DO NORTE	
RECUPERAÇÃO DE ESTRADAS VICINAIS NO MUNICÍPIO DE GUARACIABA DO NORTE-CE - PI 1386270-03	
ESTAQUEAMENTO E PERFIL LONGITUDINAL	
Projeto	ELABORADO POR: JOTA CARLOS PROJETO
Execução	ELABORADO POR: JOTA CARLOS PROJETO

3 / 08
 Escala: H 1:1000 V 1:100

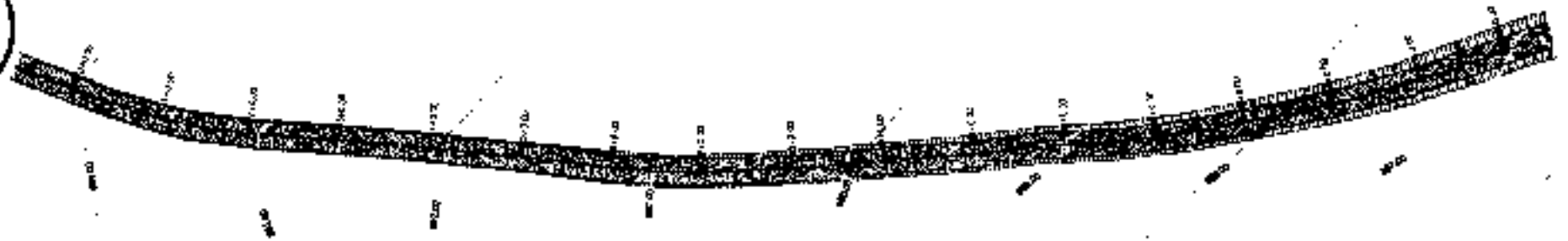

1:1000 2000

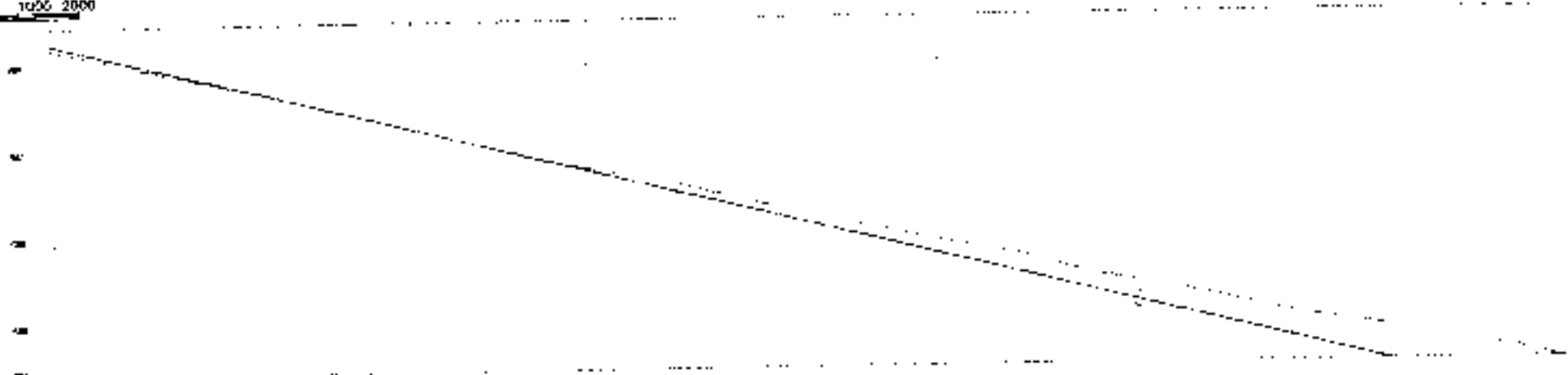

0+00	0+10	0+20	0+30	0+40	0+50	0+60	0+70	0+80	0+90	1+00	1+10	1+20	1+30	1+40	1+50	1+60	1+70	1+80	1+90	2+00
10	10	10	10	10	10	10	10	10	10	10	10	10	10	10	10	10	10	10	10	10
10	10	10	10	10	10	10	10	10	10	10	10	10	10	10	10	10	10	10	10	10
10	10	10	10	10	10	10	10	10	10	10	10	10	10	10	10	10	10	10	10	10

CONCRETO	ASfalto	ESTRADA	FAIXA	VAZÃO	POSTE	TRECHO	CAVADO	ESTRUTURA



PREFEITURA MUNICIPAL DE GUARACIABA DO NORTE		TOTAL >
RECUPERAÇÃO DE ESTRADAS VICINAIS NO MUNICÍPIO DE GUARACIABA DO NORTE - CF - PT 1006270-03		4 108
ESTACQUEAMENTO E PERFIL LONGITUDINAL		
PROJETO	10.23 F. 1	1:1000
PROJETO	10.23 F. 1	V. 1/100

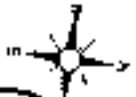

0 1000 2000

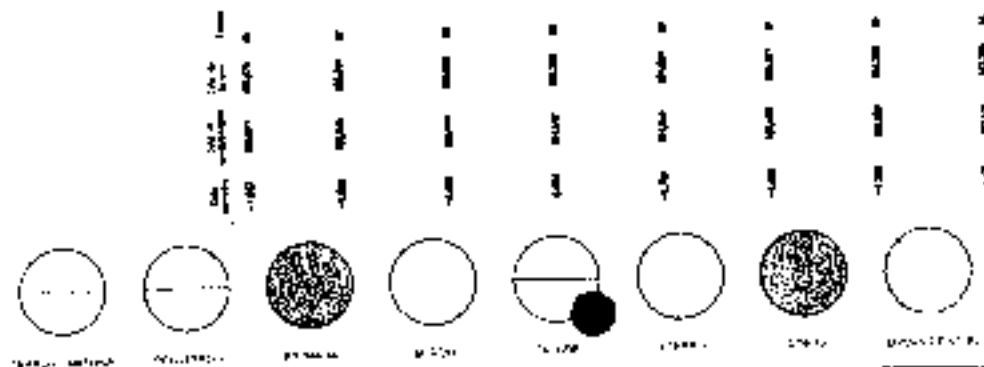
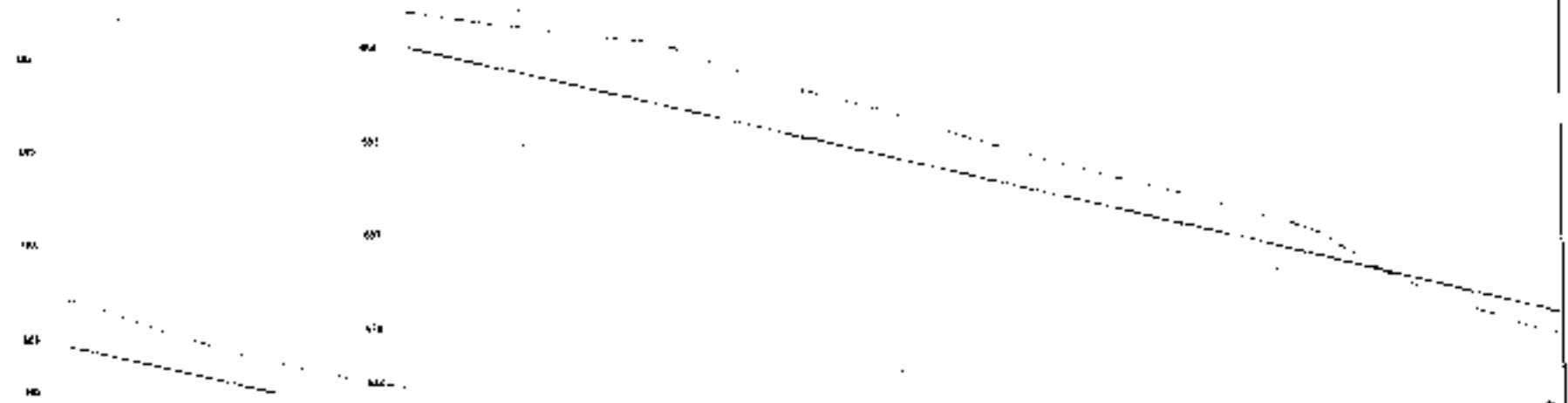
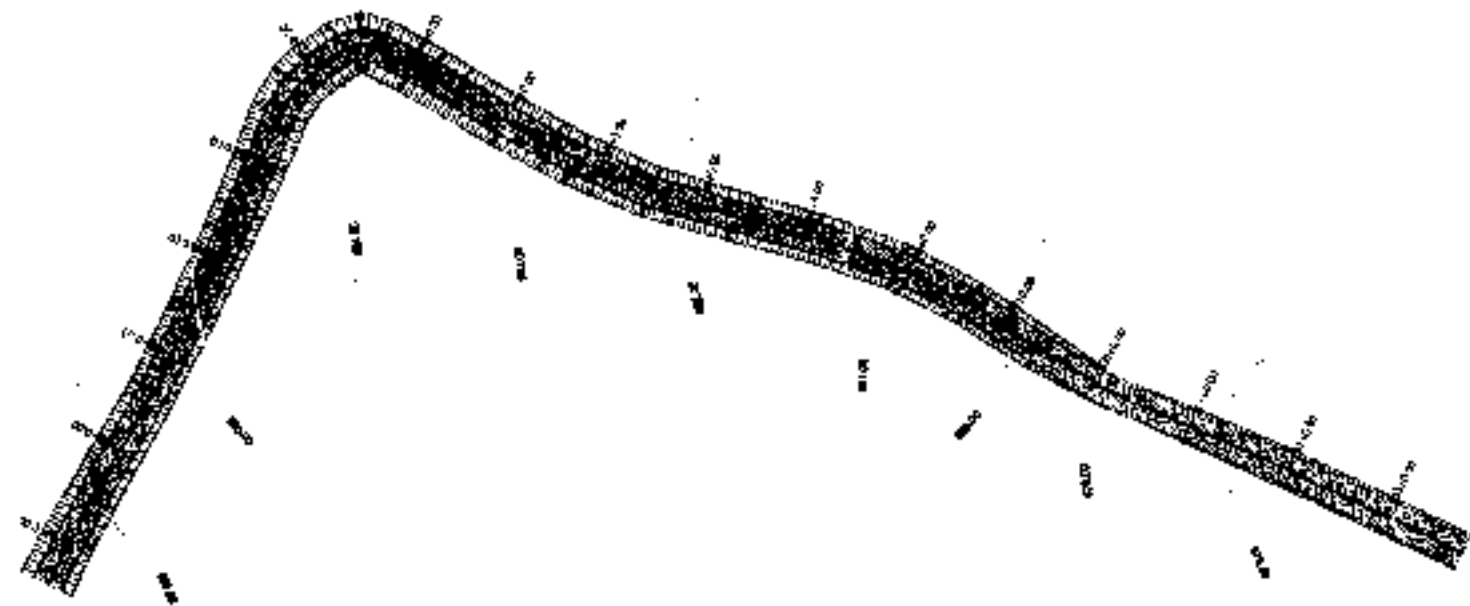

PREFEITURA MUNICIPAL DE GUARACIABA DO NORTE RECUPERAÇÃO DE ESTRADAS VICINAIS NO MUNICÍPIO DE GUARACIABA DO NORTE-CE - PT 10061770-02		Nº 5 / 08
ESTADUEAMENTO E PERFIL LONGITUDINAL		ESCALA H 1:1000 V 1:1000
DATA 10/08/08	LOCAL GUARACIABA DO NORTE, RS	PROJETO COTA BARRAS E ADRIANO

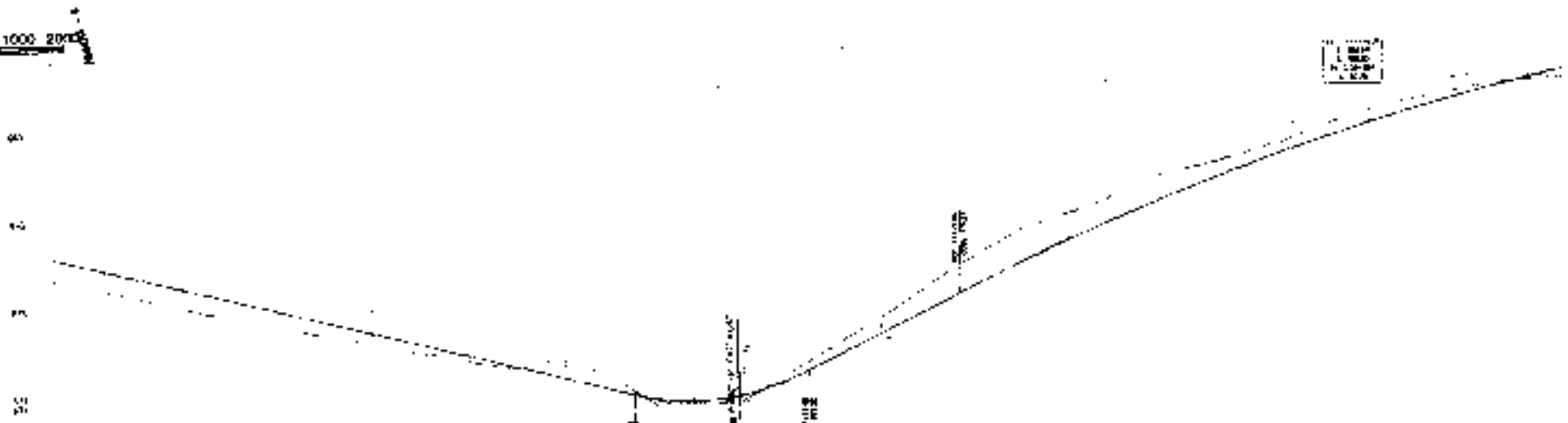
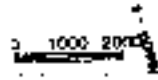

0+00	0+10	0+20	0+30	0+40	0+50	0+60	0+70	0+80	0+90	1+00	1+10	1+20	1+30	1+40	1+50	1+60	1+70	1+80	1+90	2+00
ELV. TER.	ELV. TER.	ELV. TER.	ELV. TER.	ELV. TER.	ELV. TER.	ELV. TER.	ELV. TER.	ELV. TER.	ELV. TER.	ELV. TER.	ELV. TER.	ELV. TER.	ELV. TER.	ELV. TER.	ELV. TER.	ELV. TER.	ELV. TER.	ELV. TER.	ELV. TER.	ELV. TER.
ELV. PROJ.	ELV. PROJ.	ELV. PROJ.	ELV. PROJ.	ELV. PROJ.	ELV. PROJ.	ELV. PROJ.	ELV. PROJ.	ELV. PROJ.	ELV. PROJ.	ELV. PROJ.	ELV. PROJ.	ELV. PROJ.	ELV. PROJ.	ELV. PROJ.	ELV. PROJ.	ELV. PROJ.	ELV. PROJ.	ELV. PROJ.	ELV. PROJ.	ELV. PROJ.



PRELATORIA MUNICIPAL DE GUARACIABA DO NORTE RECUPERAÇÃO DE ESTRADAS VICINAIS NO MUNICÍPIO DE GUARACIABA DO NORTE - PT. VARRZEDUJ	
ESTAQUEAMENTO E PERFIL LONGITUDINAL	
PROJ. EXECUTIVO	PROJ. EXECUTIVO

6 / 08
ESCALA HORIZONTAL V. 1:100

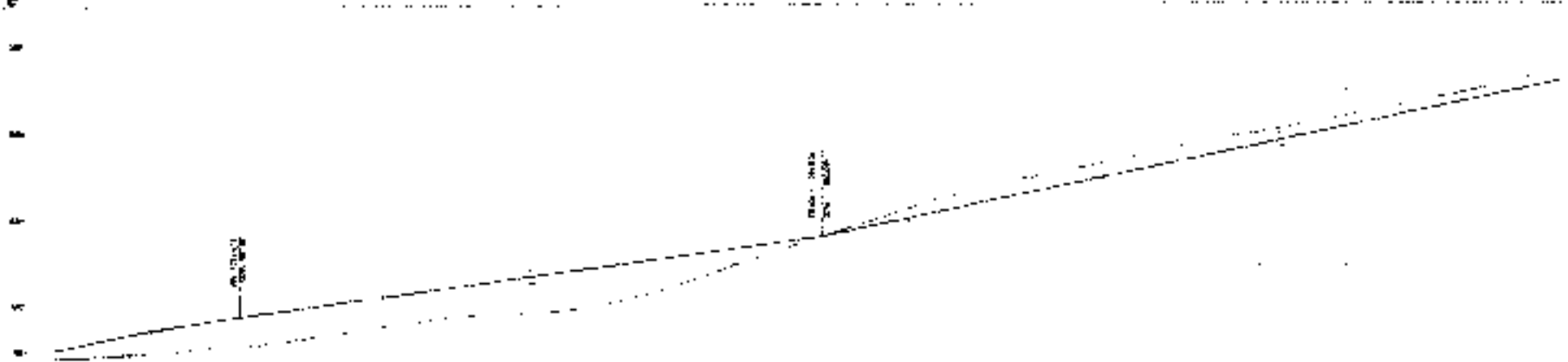
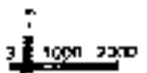

1+00	1+10	1+20	1+30	1+40	1+50	1+60	1+70	1+80	1+90	1+00	1+10	1+20	1+30	1+40	1+50	1+60	1+70	1+80	1+90
1.00	1.10	1.20	1.30	1.40	1.50	1.60	1.70	1.80	1.90	2.00	2.10	2.20	2.30	2.40	2.50	2.60	2.70	2.80	2.90
1.00	1.10	1.20	1.30	1.40	1.50	1.60	1.70	1.80	1.90	2.00	2.10	2.20	2.30	2.40	2.50	2.60	2.70	2.80	2.90
1.00	1.10	1.20	1.30	1.40	1.50	1.60	1.70	1.80	1.90	2.00	2.10	2.20	2.30	2.40	2.50	2.60	2.70	2.80	2.90

PAVIMENTO	FAIXA	SUPERFÍCIE	BOCA	DESA	ALARGAMENTO	DESA	DESA



PREFEITURA MUNICIPAL DE GUARACIABA DO NORTE	
RECUPERAÇÃO DE ESTRADAS VICINAIS NO MUNICÍPIO DE GUARACIABA DO NORTE-CE - PT 145270403	
ESTAGUAMENTO E PERFIL LONGITUDINAL	
PROJETO	100% DE PROJETO EXECUTIVO
APROVADO	100% DE PROJETO EXECUTIVO

7 / 08
H 1:1000 V 1:100



0 1000 2000

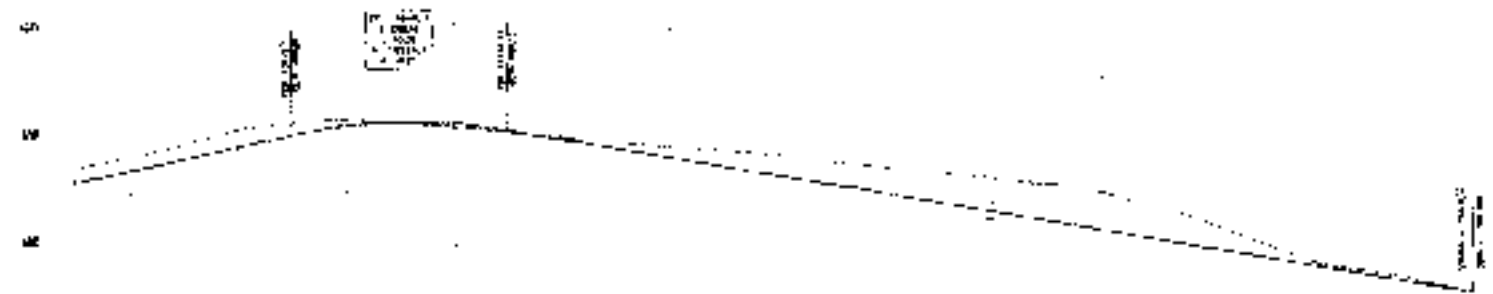

1	2	3	4	5	6	7	8	9	10	11	12	13	14	15	16	17	18	19	20
100	100	100	100	100	100	100	100	100	100	100	100	100	100	100	100	100	100	100	100
100	100	100	100	100	100	100	100	100	100	100	100	100	100	100	100	100	100	100	100
100	100	100	100	100	100	100	100	100	100	100	100	100	100	100	100	100	100	100	100



PREFEITURA MUNICIPAL DE GUARACIABA DO NORTE	
RECUPERAÇÃO DE ESTRADAS VICINAIS NO MUNICÍPIO DE GUARACIABA DO NORTE - R\$ - R\$ 1006270,00	
ESTACQUEAMENTO E PERFIL LONGITUDINAL	
PROJETO: []	DATA: []
PROJETO: []	DATA: []

8 / 08
 4:1 1000
 1:1 1000



LEGENDA

-  ATERRO
-  CORTF

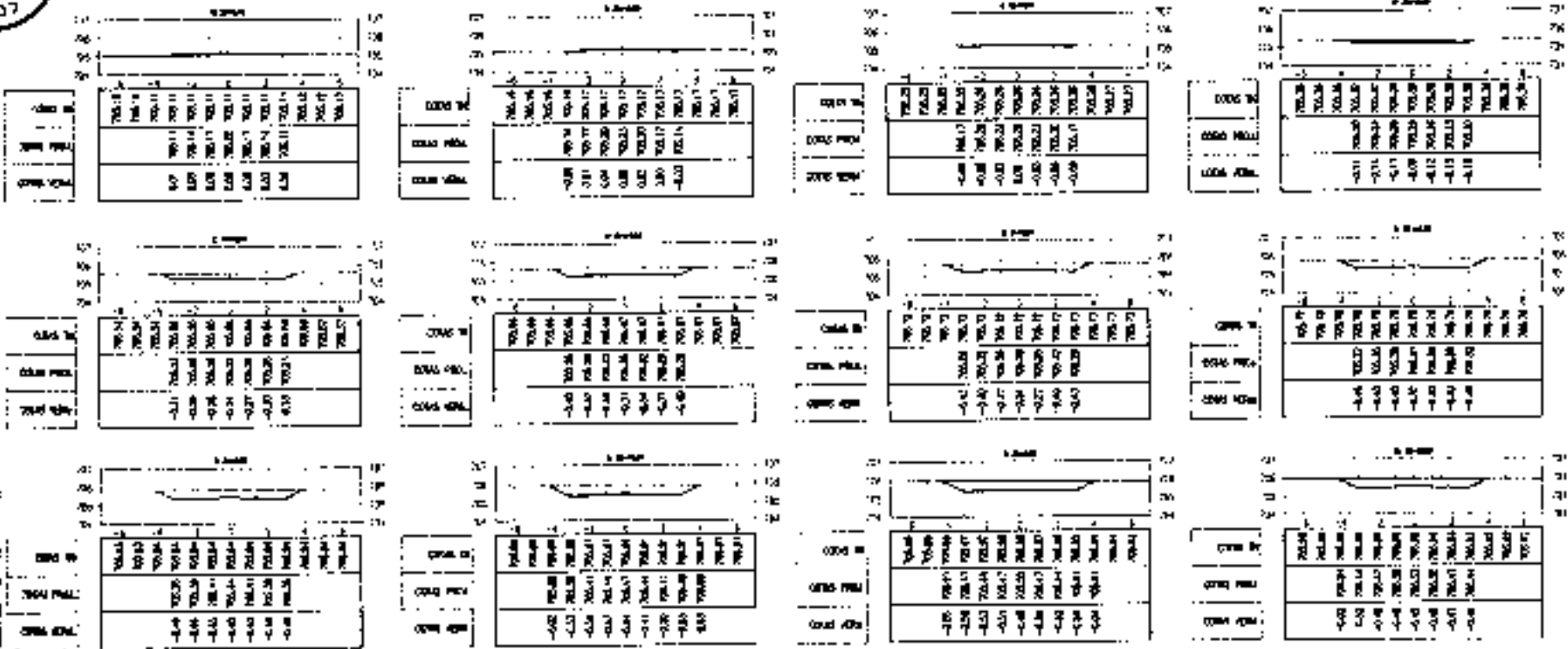

	PRFFETURA MUNICIPAL DE GUARACIABA DO NORTE		Folha n. 1 / 14
	RECUPERAÇÃO DE ESTRADAS VICINAIS NO MUNICÍPIO DE GUARACIABA DO NORTE-CE (P. 10662/0-00)		escala 1:250
	SEÇÕES TRANSVERSAIS		
PROJETO	EXECUÇÃO: ENGENHEIRO RESPONSÁVEL: F. L. S. JUNIOR		
PLANOS	EXECUÇÃO: ENGENHEIRO RESPONSÁVEL: F. L. S. JUNIOR		

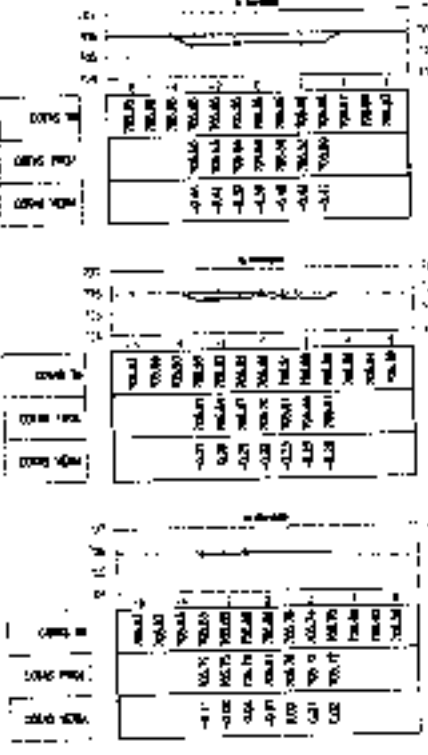
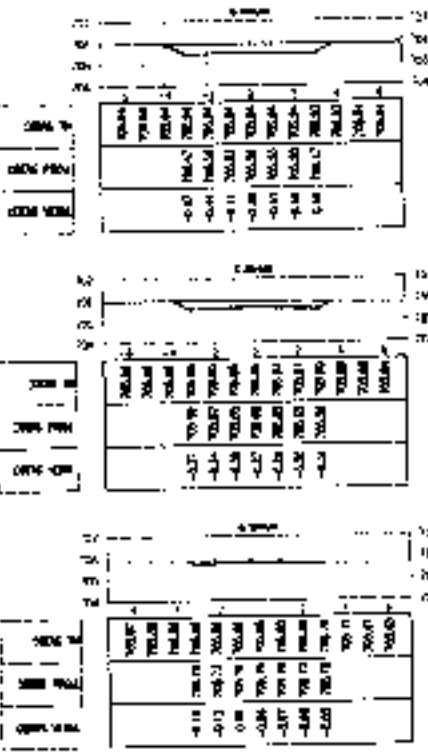

LEGENDA:

ATERRO

CORTE



PREFEITURA MUNICIPAL DE GUARACIABA DO NORTE

RECUPERAÇÃO DE ESTRADAS VICINAIS NO MUNICÍPIO DE GUARACIABA DO NORTE-CE - P/L 1086270-03

SEÇÕES TRANSVERSAIS

Projeto: LICITAÇÃO Nº 001/2014 - 15/01/2014

Medida: 10/2014 - 15/01/2014

2 / 14

1250

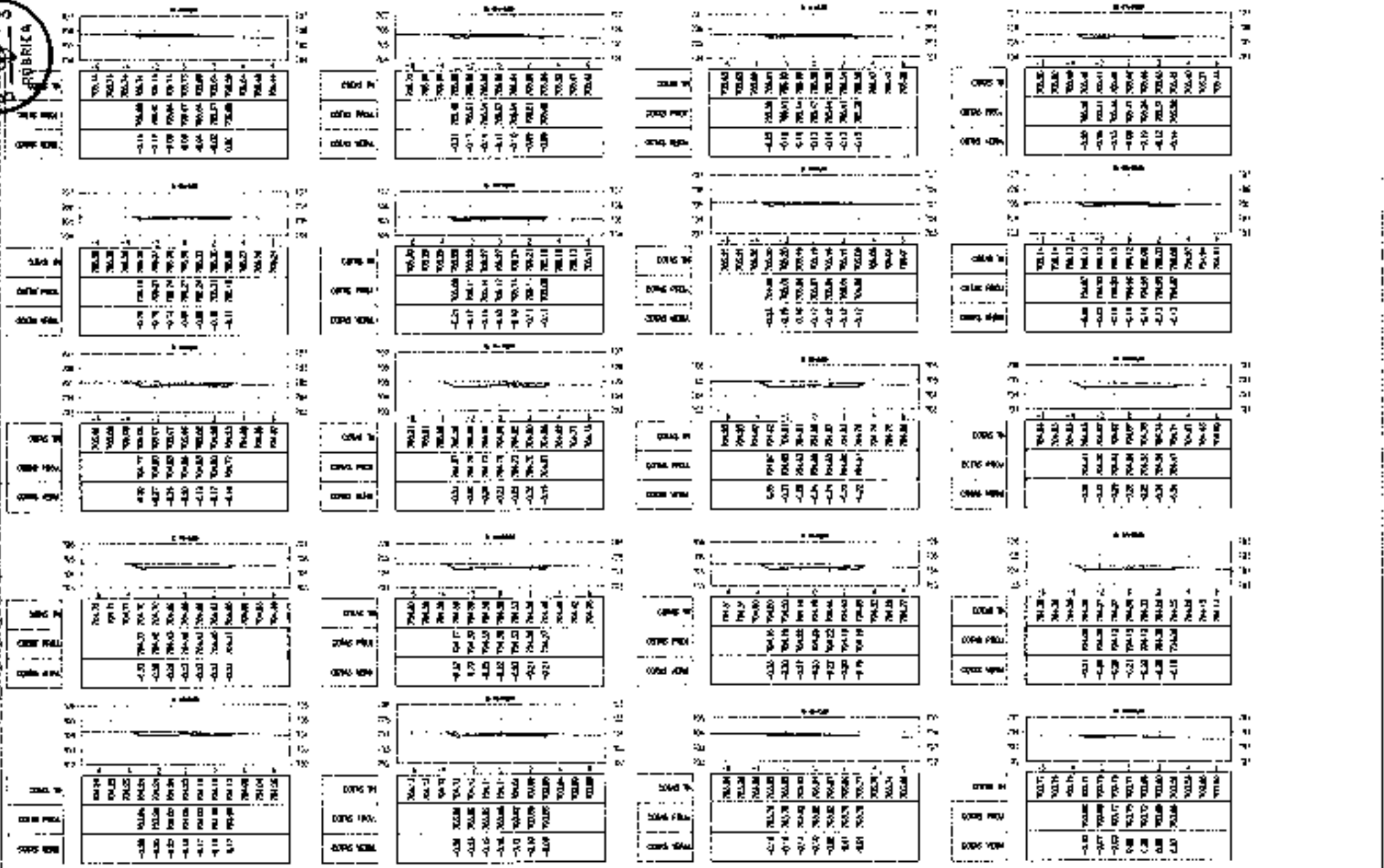

LEGENDA

- ATERRO
- CORTE



PREFEITURA MUNICIPAL DE GUARACIARA DO NORTE
 RECL. PERAÇÃO DE ESTRADAS VIC. MAIS NO MUNICÍPIO DE GUARACIARA DO NORTE-CE - PT 1086270-00
 SEÇÕES TRANSVERSAIS

Projeto	Execução
Projeto	Execução

Arquivo	3 / 14
Escala	1:250

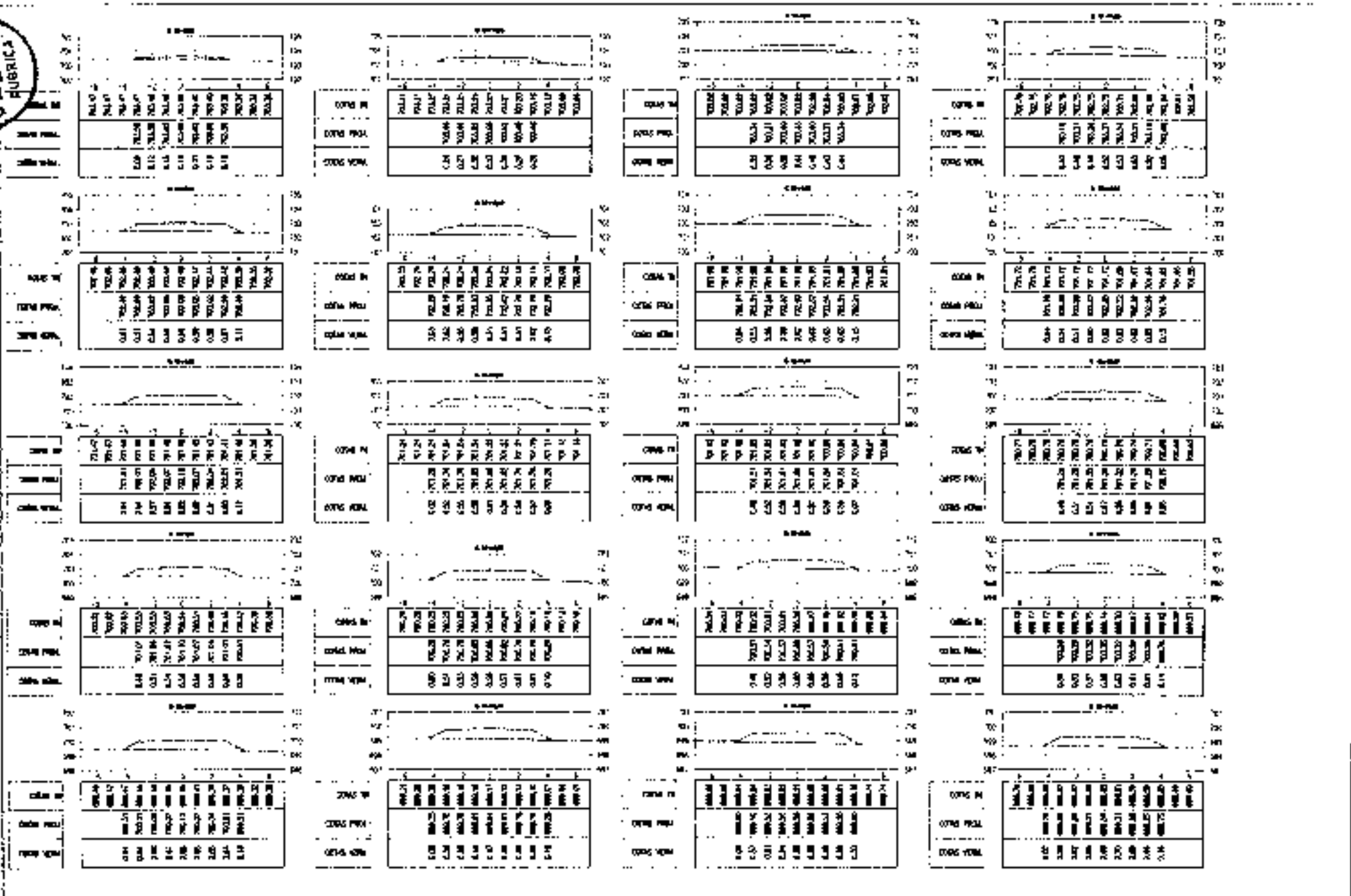

LEGENDA

ATERRÇO
 CORTE



PREFEITURA MUNICIPAL DE GUARACIABA DO NORTE

RECONSTRUÇÃO DE ESTRADAS VICINAIS NO MUNICÍPIO DE GUARACIABA DO NORTE-CE - PT 1386270-03



SEÇÕES TRANSVERSAIS

PROJETO DE ARQUITETURA E ENGENHARIA

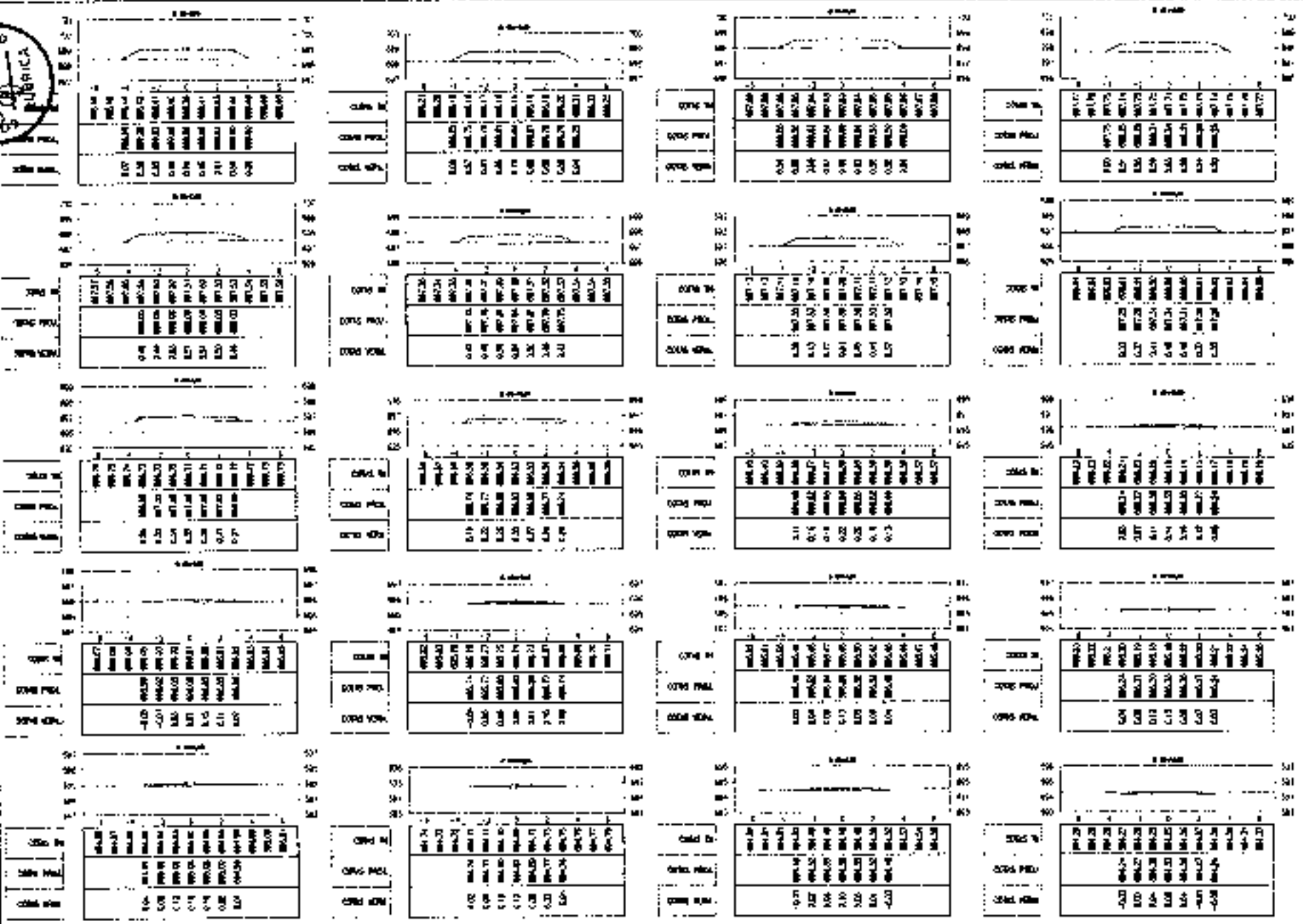
PROJETO DE ENGENHARIA DE ESTRUTURAS



LEGENDA

-  ATERRO
-  CORTE



PREFEITURA MUNICIPAL DE GUARACIARA DO NORTE

RECONSTRUÇÃO DE ESTRADAS VICINAIS NO MUNICÍPIO DE GUARACIARA DO NORTE-CE - PT 1086270-03

SEÇÕES TRANSVERSAIS

PRIMEIRA

5 / 14

TERCEIRA

1/250

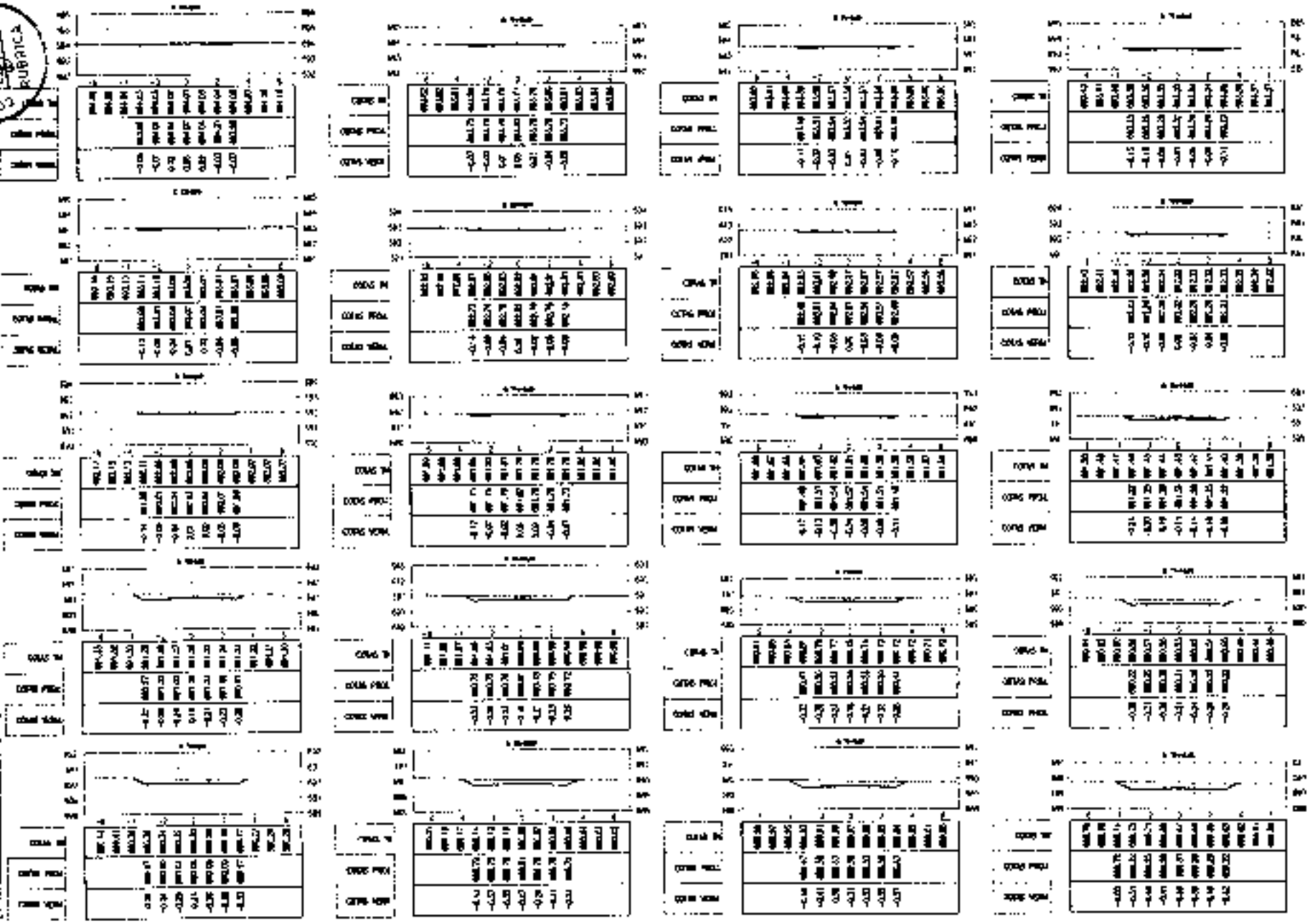

LEGENDA

 ATERRO

 CORTE



PREFEITURA MUNICIPAL DE GUARACABA DO NORTE

RECUPERAÇÃO DE ESTRADAS VICIAIS NO MUNICÍPIO DE GUARACABA DO NORTE - CE - PT 108627043

SEÇÕES TRANSVERSAIS

WELSON

FOLHA

6 / 14

ESCALA

1:250

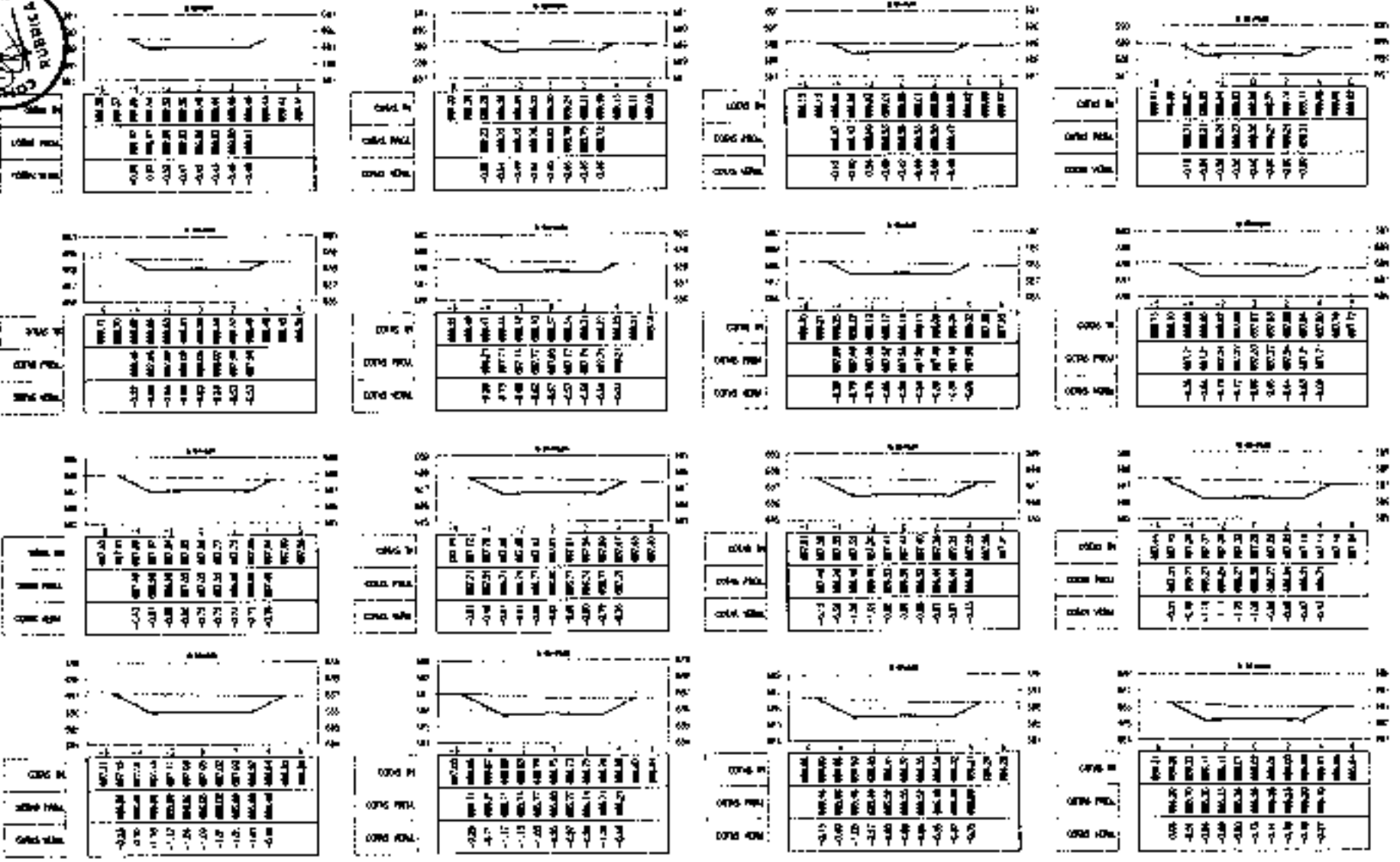

LEGENDA:

ATERRÃO

CORTE



PREFEITURA MUNICIPAL DE GUARACEMA DO NORTE

RECUPERAÇÃO DE ESTRADAS VICINAIS NO MUNICÍPIO DE GUARACEMA DO NORTE-CE - P1 10062/003

SEÇÕES TRANSVERSAIS

PROJETO DE ARQUITETURA E LAYOUT

PROF. DR. JOÃO CARLOS BARROS

7 / 14

1:250

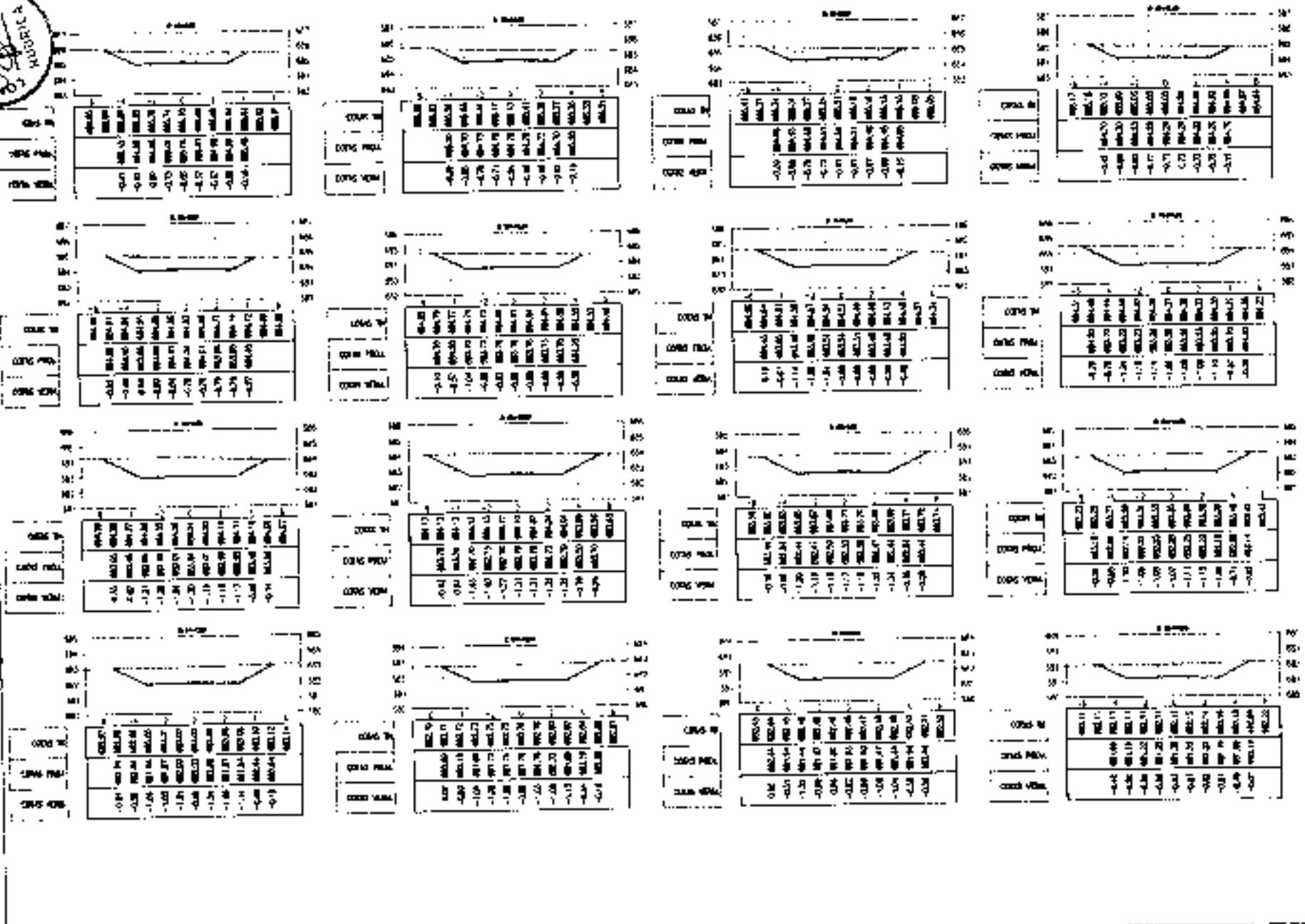

LEGENDA:
 ATERRO
 CORTE

NOTA BARROS
PROJETOS

PREFEITURA MUNICIPAL DE GUARACIABA DO NORTE

RECUPERAÇÃO DE ESTRADAS VICINAIS NO MUNICÍPIO DE GUARACIABA DO NORTE - CE - PT 10R6270-01

SEÇÕES TRANSVERSAIS

8 / 14

1:250



LEGENDA

-  ALTO
-  BAIXO



PREFEITURA MUNICIPAL DE GUARACIABA DO NORTE
 RECUPERAÇÃO DE ESTRADAS VICINAIS NO MUNICÍPIO DE GUARACIABA DO NORTE-CE - PT 1086270-00

SEÇÕES TRANSVERSAIS

11/14
 1:250

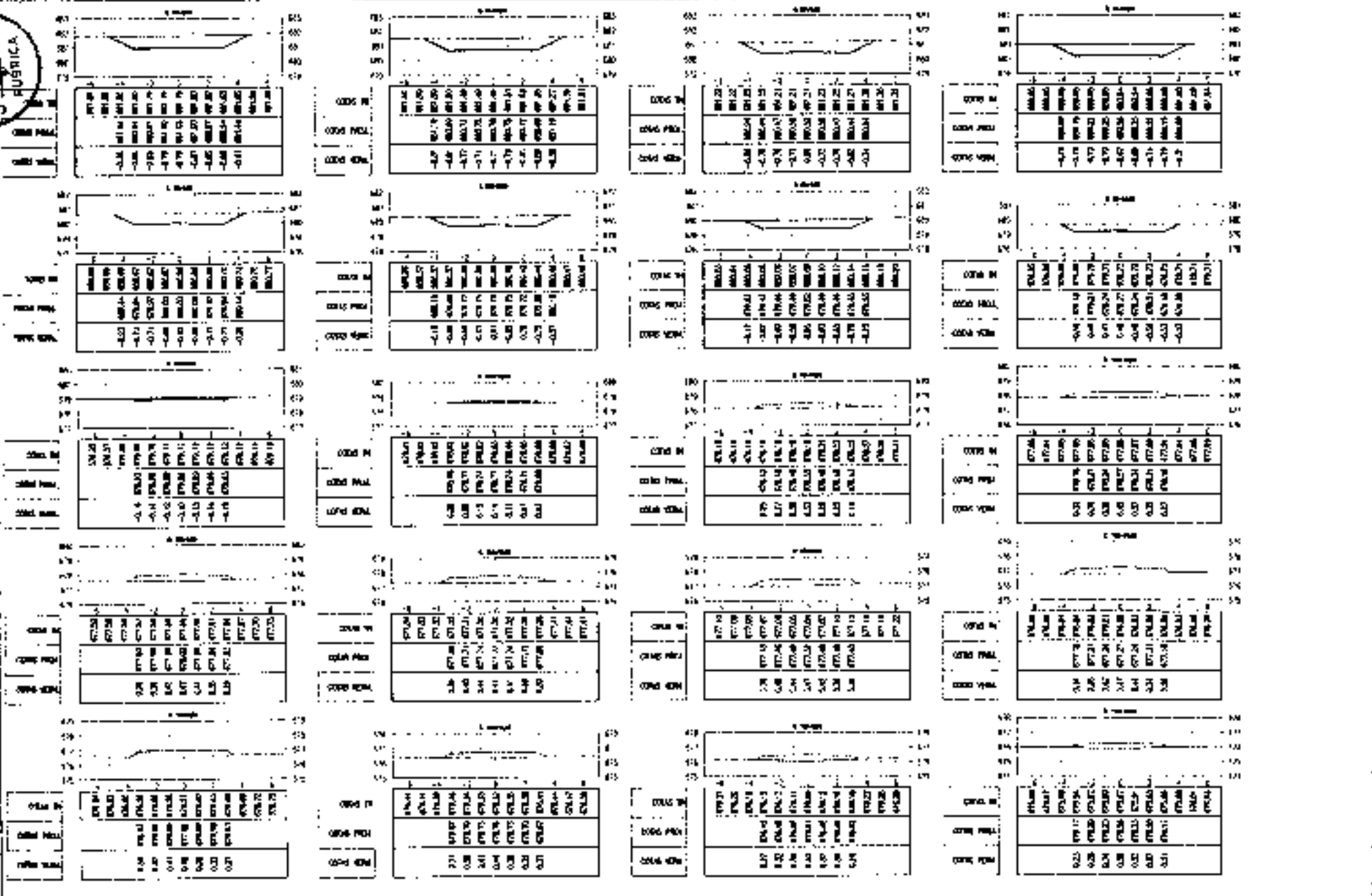

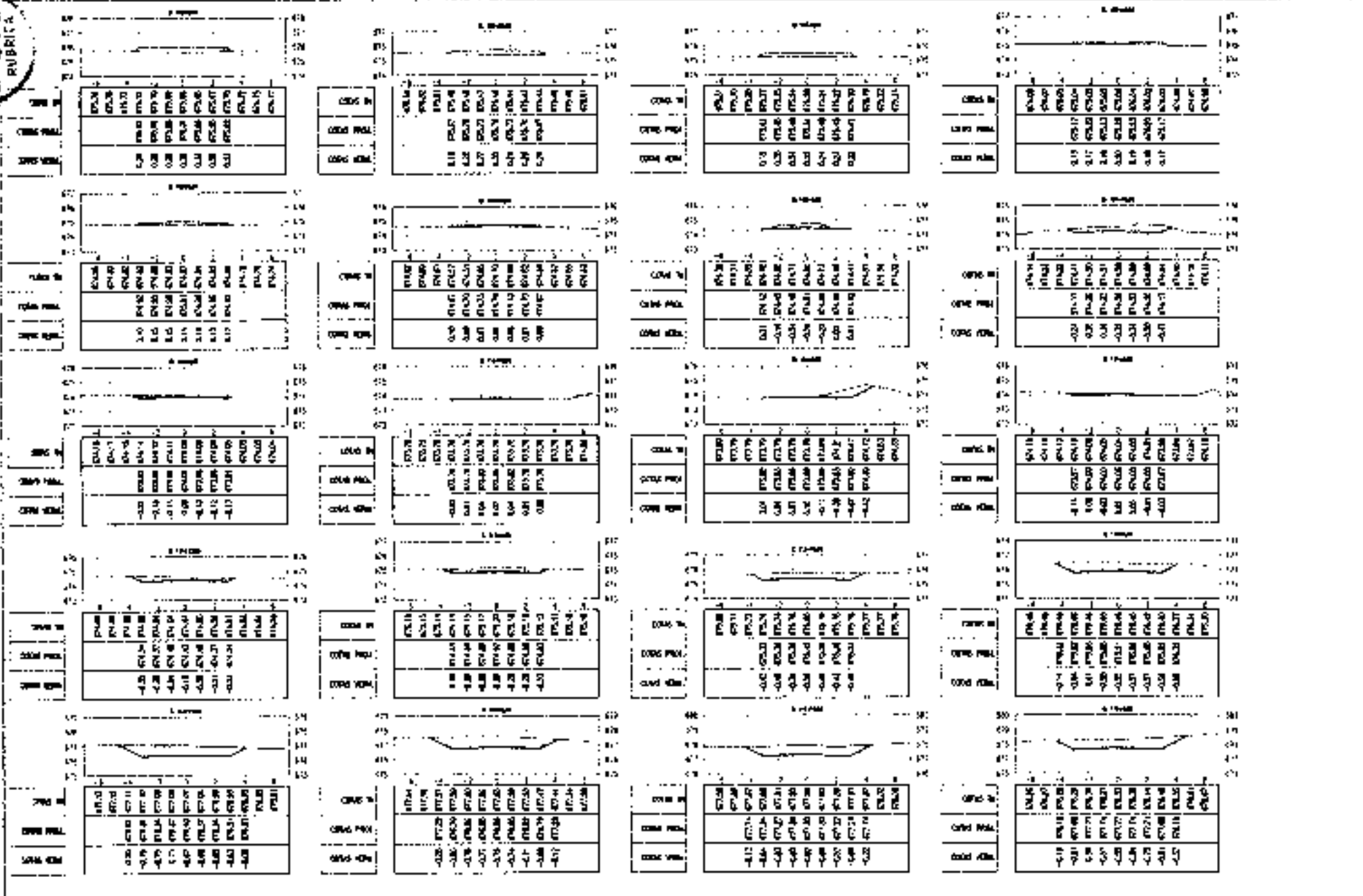

LEGENDA

ATERRO

CUNTEL

	PREFEITURA MUNICIPAL DE GUARACIABA DO NORTE		10 / 14
	RECUPERAÇÃO DE ESTRADAS VICINAIS NO MUNICÍPIO DE GUARACIABA DO NORTE-CE - PT 1086270-03		1/250
	SEÇÕES TRANSVERSAIS		1/250

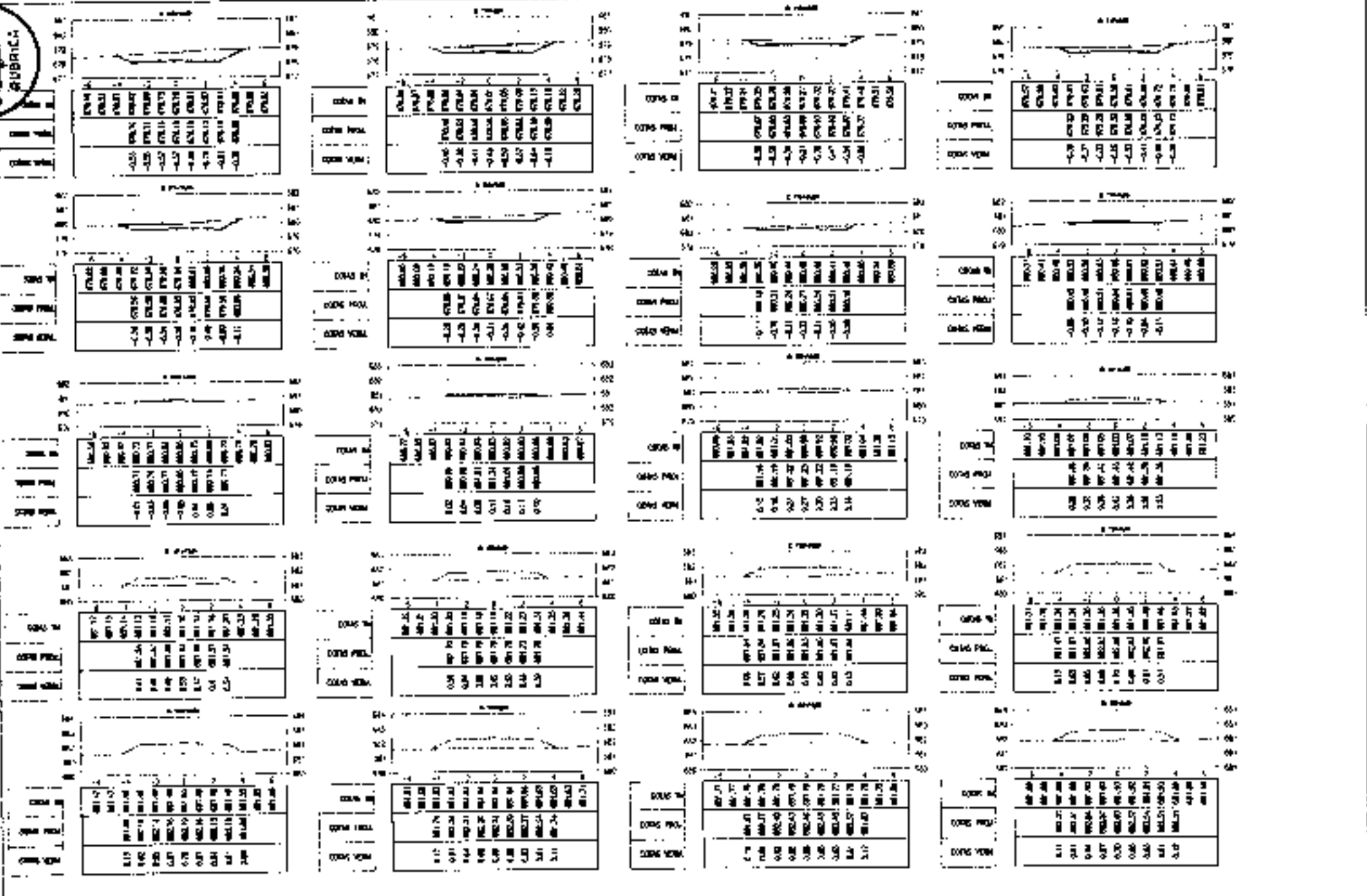

LEGENDA

ALIENIO

CORTA



PREFEITURA MUNICIPAL DE GUARACIABA DO NORTE RECUPERAÇÃO DE ESTRADAS VICINAIS NO MUNICÍPIO DE GUARACIABA DO NORTE-CE - PT 1066270-02 SEÇÕES TRANSVERSAIS		FOLHA 11 / 14 ESCALA 1:250
DATA 10/07/2010	LOCAL RUA JOSÉ DE ALMEIDA, S/Nº, GUARACIABA DO NORTE, CE	
PROJETO ENG. CIVIL CARLOS AUGUSTO DE MENEZES	EXECUÇÃO ENG. CIVIL CARLOS AUGUSTO DE MENEZES	

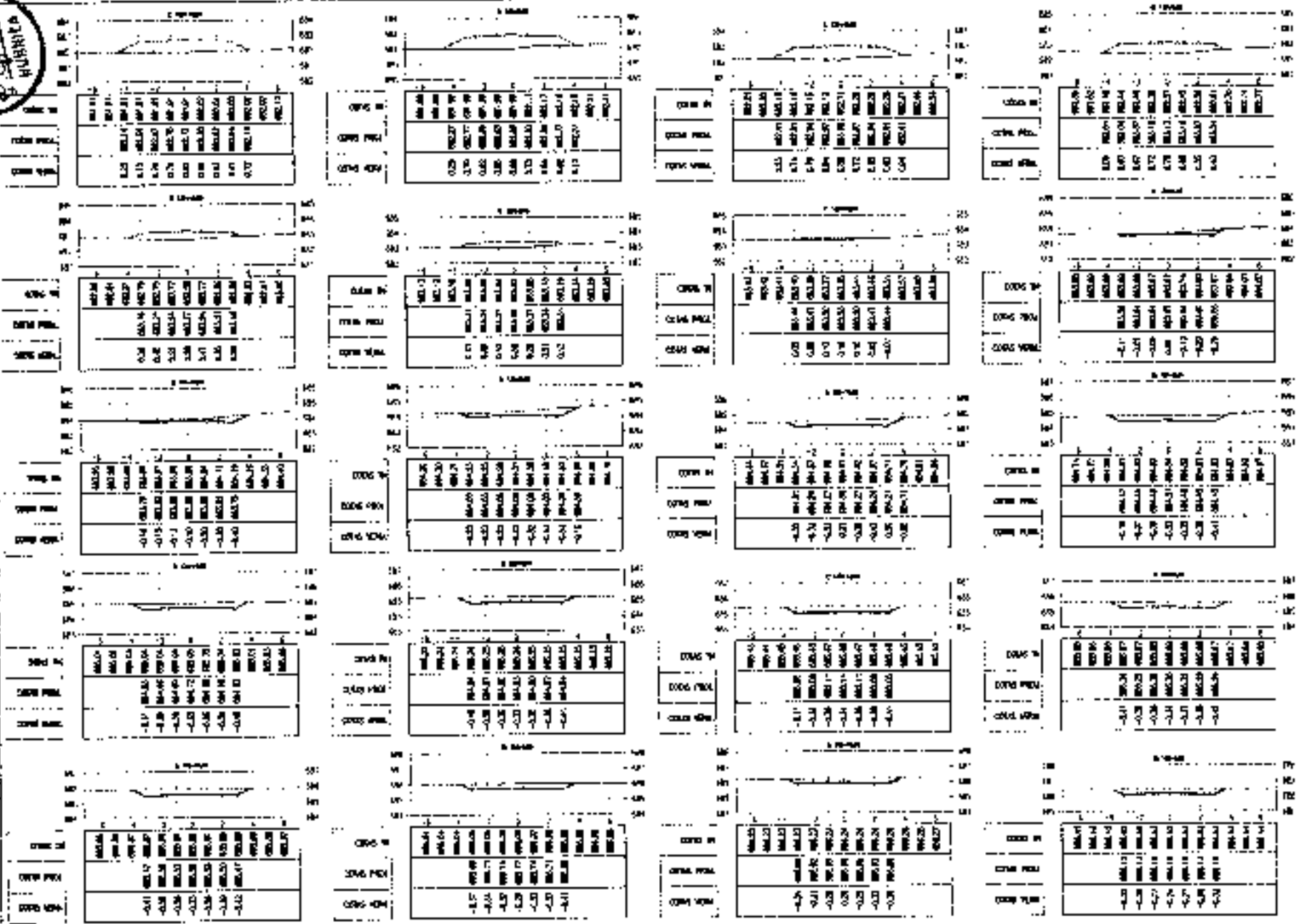

LEGENDA

ATENHO

CORTE

	<p>PREFETURA MUNICIPAL DE GUARACIABA DO NORTE</p> <p>RECLERAÇÃO DE ESTRADAS VICINAIS NO MUNICÍPIO DE GUARACIABA DO NORTE-CE - PT 1085270-33</p> <p>SEÇÕES TRANSVERSAIS</p>		<p>12 / 14</p>
	<p>ENCARGOS</p>	<p>PROJETO</p>	<p>1:250</p>
	<p>PROJETO</p>		<p>1:250</p>

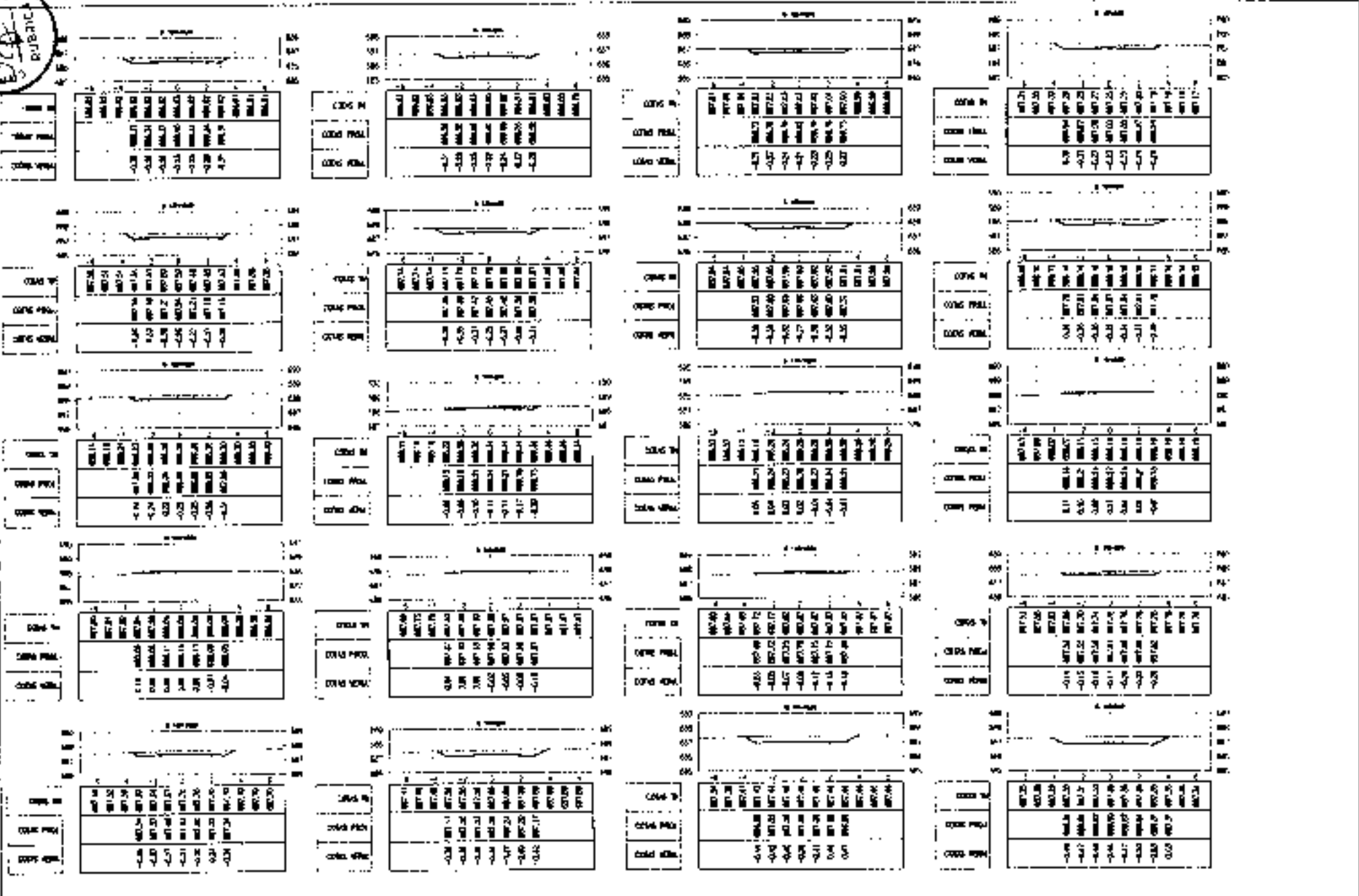

LEGENDA

ATERRO

CORTA



PREFEITURA MUNICIPAL DE GUARACIARA DO NORTE

RECLPERAÇÃO DE ESTRADAS VICINAIS NO MUNICÍPIO DE GUARACIARA DO NORTE-CE - PY 1986270-03

SEÇÕES TRANSVERSAIS

PROJ. DE: [blank]

PROJ. DE: [blank]



LEGENDA

-  ATILHADO
-  CORTE

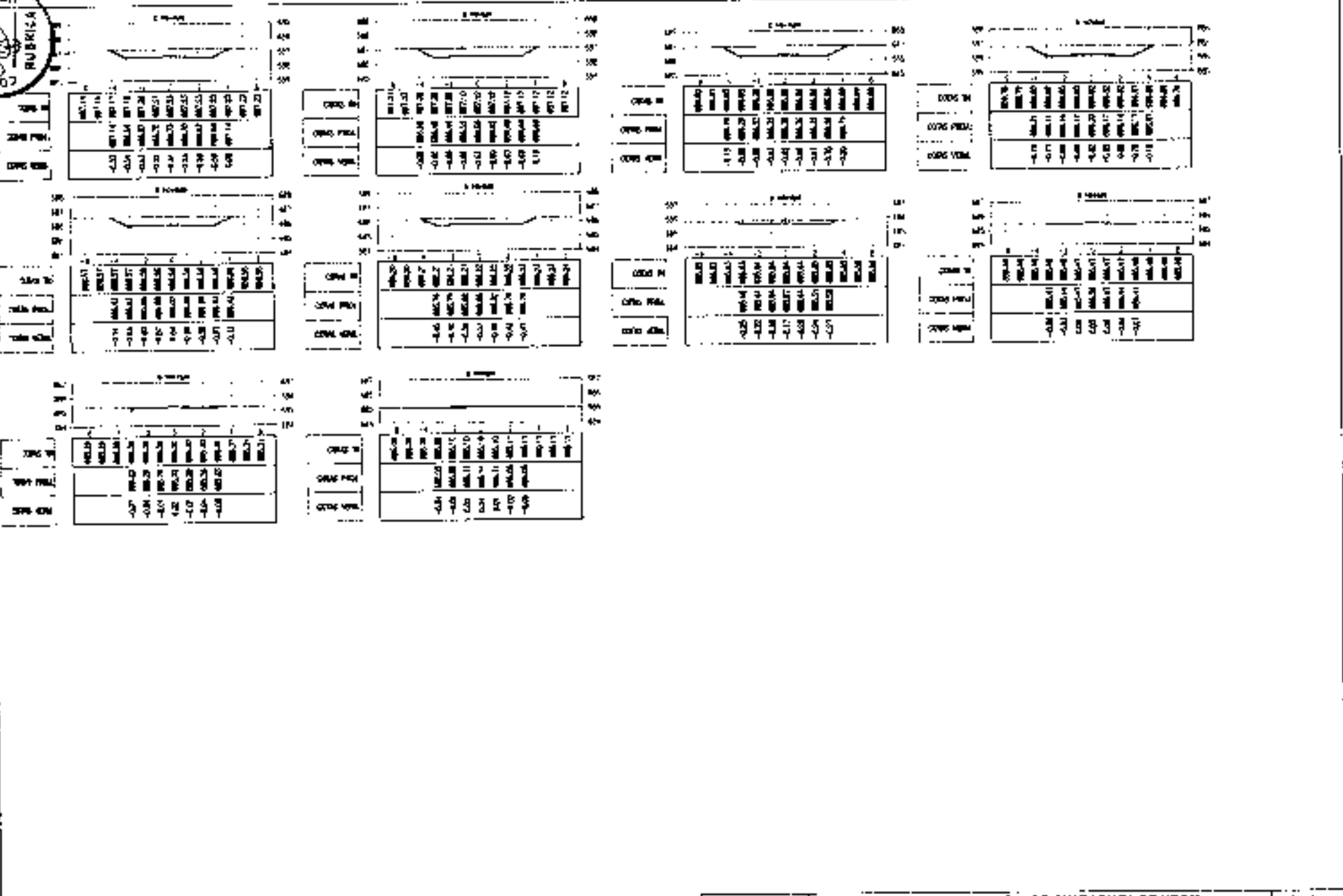

PREFEITURA MUNICIPAL DE GUARACIABA DO NORTE		14 / 14
RECUPERAÇÃO DE ESTRADAS VICINAIS NO MUNICÍPIO DE GUARACIABA DO NORTE - CE - IPT 2006270-03		1/250
SEÇÕES TRANSVERSAIS		
PROJETO DE RECUPERAÇÃO DE ESTRADAS VICINAIS		
PROJETO DE RECUPERAÇÃO DE ESTRADAS VICINAIS		



1000

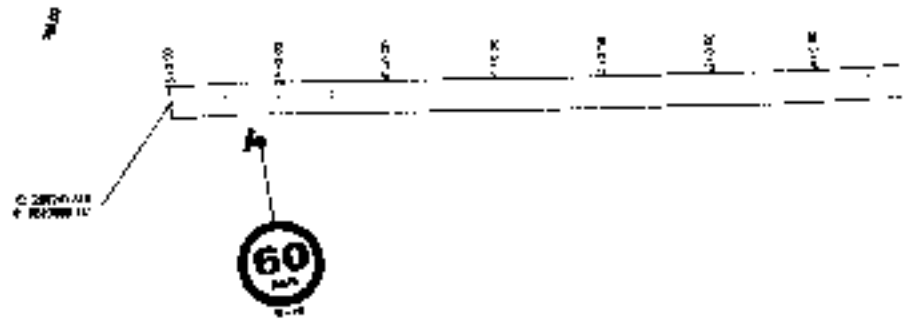
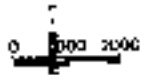

	PREFEITURA MUNICIPAL DE GUARACIABA DO NORTE RECUPERAÇÃO DE ESTRADAS VICINAIS NO MUNICÍPIO DE GUARACIABA DO NORTE-CE - PI 1086270/13		ESCALA 1 / 06
	BINALIZAÇÃO VIÁRIA		ESCALA 1 / 000
DATA 10/05/2013	LOCAL RUA...	PROJETO ...	



0 1000 2000



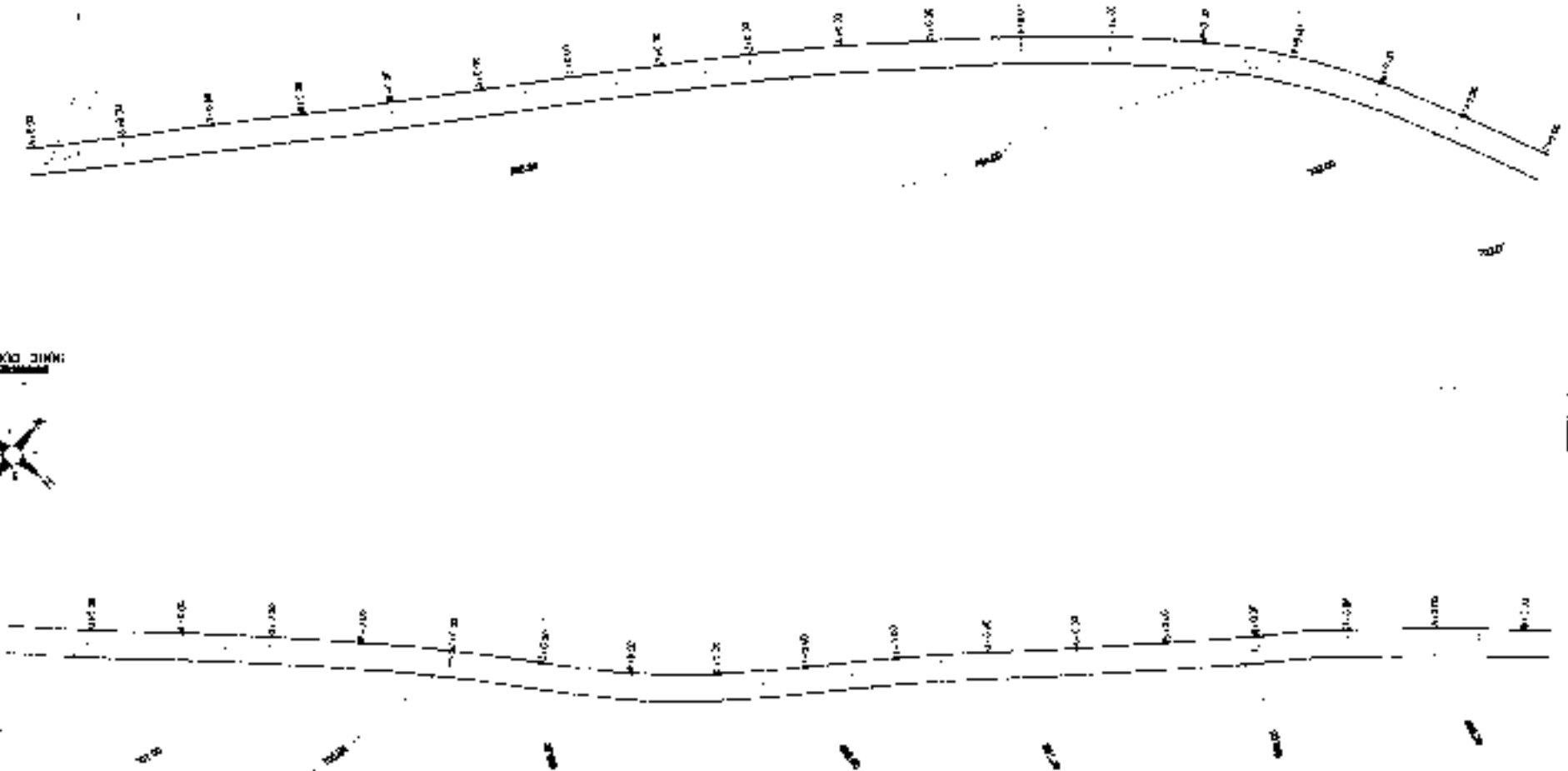

0 1000 2000

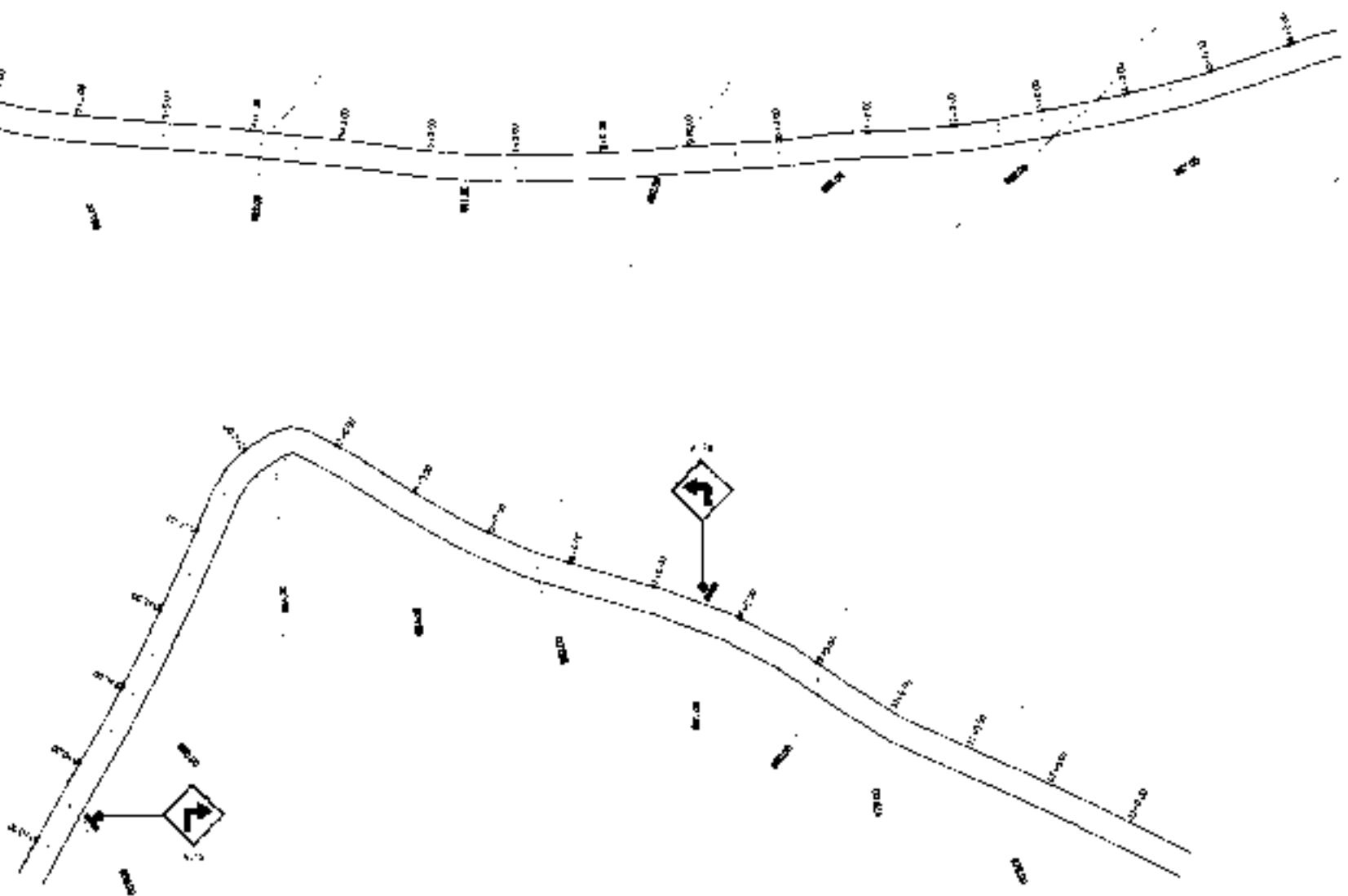
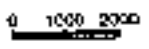
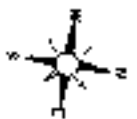
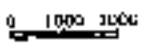

PREFEITURA MUNICIPAL DE GUARACIABA DO NORTE RECUPERAÇÃO DE ESTRADAS VICINAIS NO MUNICÍPIO DE GUARACIABA DO NORTE-CE - PT 1086279-03 SINALIZAÇÃO VIÁRIA	
Nº PROJETO: 1086279-03 Nº CADASTRO: 1086279-03	DATA: 10/06/2006 LOCAL: GUARACIABA DO NORTE - CE

ESCALA: 1:1000
 DATA: 10/06/2006



	PREFEITURA MUNICIPAL DE GUARACIABA DO NORTE		3 / 05
	REFORTECIMENTO DE ESTRADAS VICIAIS NO MUNICÍPIO DE GUARACIABA DO NORTE - CE - PT 1086270-03		171000
	SINALIZAÇÃO VIÁRIA		
ANEXO Nº	02/2011 - RUA DE GUARACIABA DO NORTE - RUA DE GUARACIABA DO NORTE		
PROJETO Nº	10/2011 - RUA DE GUARACIABA DO NORTE - RUA DE GUARACIABA DO NORTE		



0 1000 2000

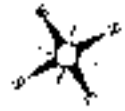

0 1000 2000

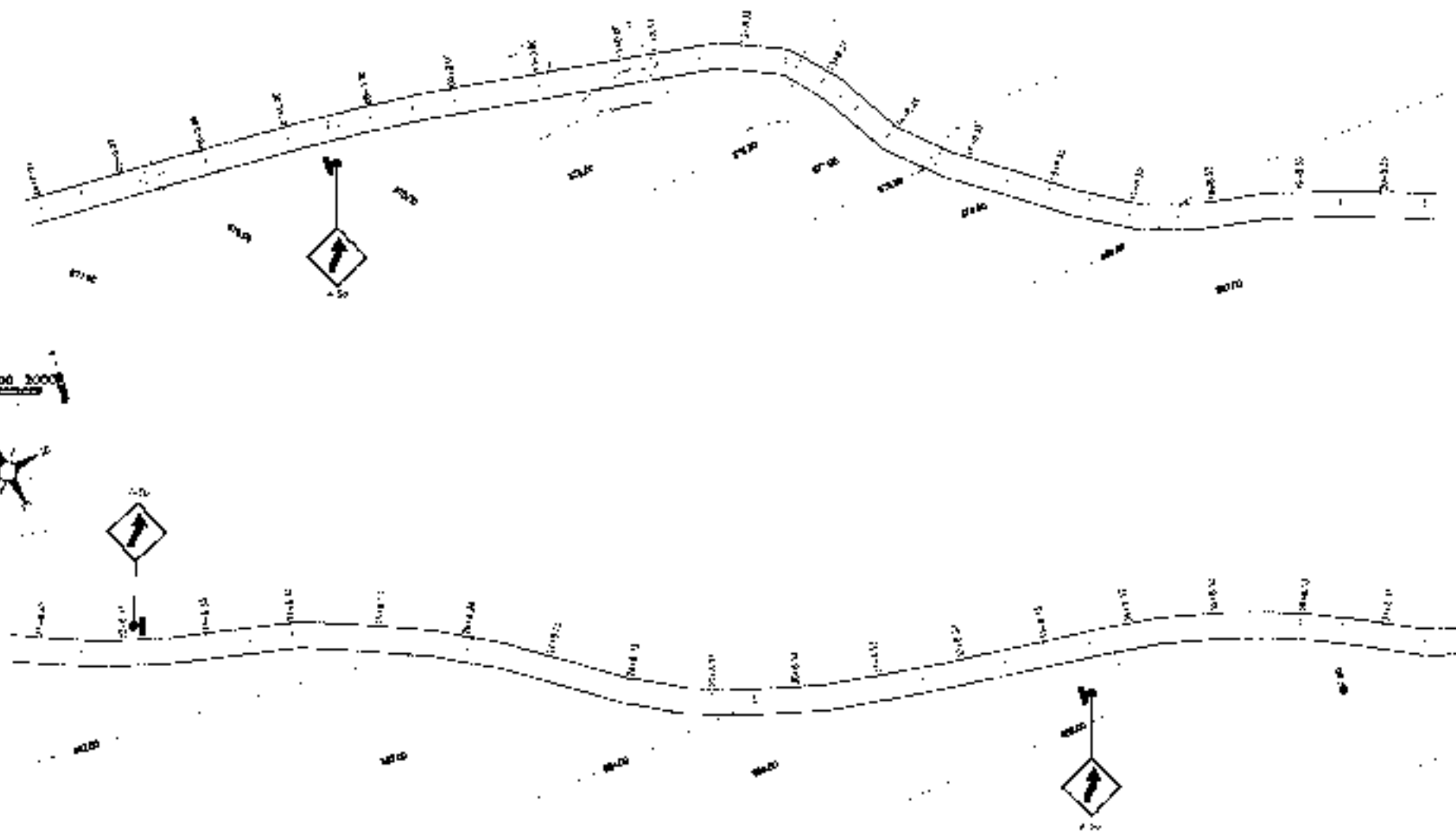

PREFEITURA MUNICIPAL DE GUARACIARA DO NORTE	
RECLIPERACÃO DE ESTRADAS VICINAIS NO MUNICÍPIO DE GUARACIARA DO NORTE-CE - PT 1086270-03	
SINALIZAÇÃO VIÁRIA	
PROJETO	2014
FEITO EM	2014

4 / 06
1:1000



1:000 2000



PREFEITURA MUNICIPAL DE GUARACIABA DO NORTE		5 / 06
RECUPERAÇÃO DE ESTRADAS VICINAIS NO MUNICÍPIO DE GUARACIABA DO NORTE-CE - PT 10862/0-03		50000
SINALIZAÇÃO VIÁRIA		1-1000
PROJ. A.	PROJ. A. SINALIZAÇÃO VIÁRIA	
PROJ. B.	PROJ. B. SINALIZAÇÃO VIÁRIA	



Posicionamento transversal

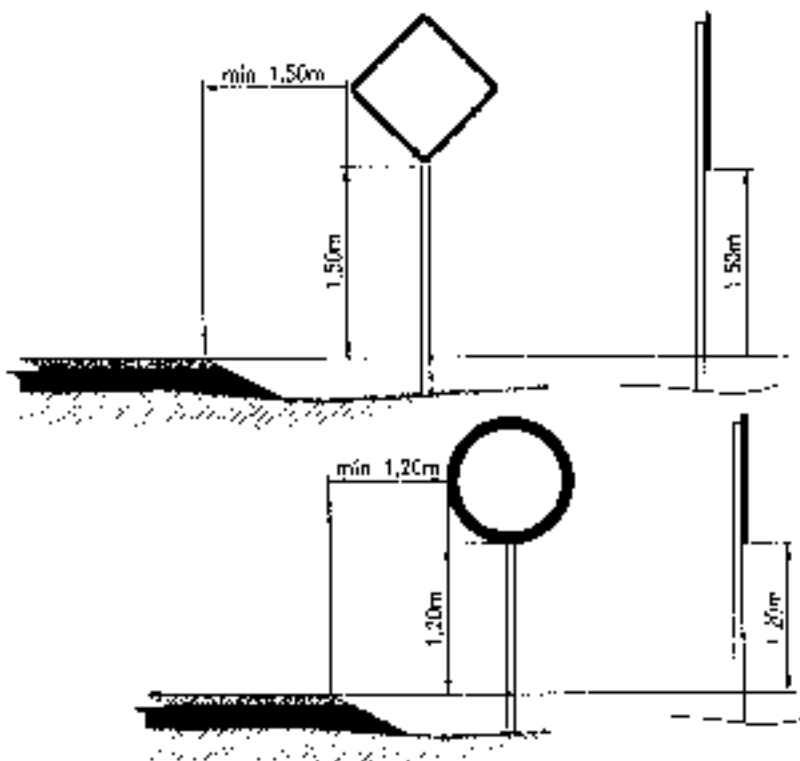

PLACAS DE ADVERTÊNCIA

PLACAS	QUANTIDADE	VALOR UNITÁRIO (R\$)	VALOR TOTAL (R\$)
	01	1.500,00	1.500,00

PLACAS DE ADVERTÊNCIA

PLACAS	QUANTIDADE	VALOR UNITÁRIO (R\$)	VALOR TOTAL (R\$)
	01	1.500,00	1.500,00
	01	1.500,00	1.500,00
	01	1.500,00	1.500,00

As Placas de Advertência tem as seguintes especificações:

- Local - 0,80m
- Órg. interna - 2,01m
- Órg. externa - 2,00m
- Acab. - alumínio
- Órg. interna - Prata
- Órg. externa - alumínio
- Gravado - Preto
- Coroa - Preto

<p>JOTA BARROS PROJETO</p>	PREFEITURA MUNICIPAL DE GUARACAMA DO NORTE RECUPERAÇÃO DE ESTRADAS VICINAIS NO MUNICÍPIO DE GUARACAMA DO NORTE-CE. - PI 1082/0-01		6 / 06
	SINALIZAÇÃO VIÁRIA		SEM ESC
	DATA: 11/02/2020		

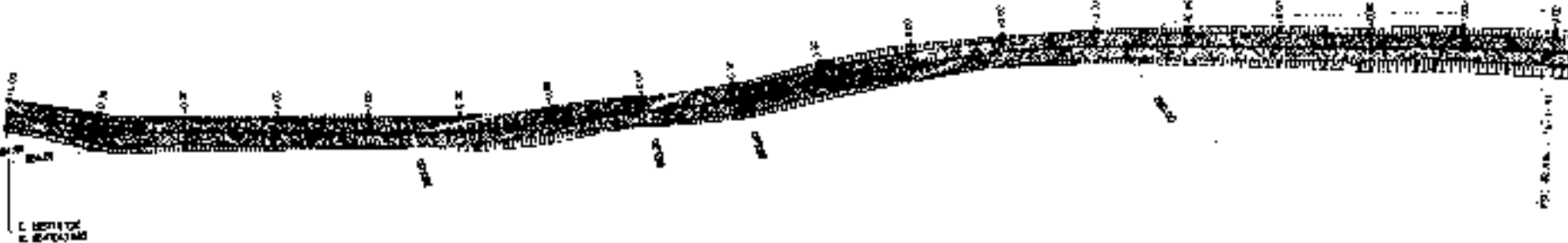

1:1000 2000

1:1000 2000

1	2	3	4	5	6	7	8	9	10	11	12	13	14	15	16	17	18	19	20	21	22	23	24	25	26	27	28	29	30	31	32	33	34	35	36	37	38	39	40	41	42	43	44	45	46	47	48	49	50	51	52	53	54	55	56	57	58	59	60	61	62	63	64	65	66	67	68	69	70	71	72	73	74	75	76	77	78	79	80	81	82	83	84	85	86	87	88	89	90	91	92	93	94	95	96	97	98	99	100
---	---	---	---	---	---	---	---	---	----	----	----	----	----	----	----	----	----	----	----	----	----	----	----	----	----	----	----	----	----	----	----	----	----	----	----	----	----	----	----	----	----	----	----	----	----	----	----	----	----	----	----	----	----	----	----	----	----	----	----	----	----	----	----	----	----	----	----	----	----	----	----	----	----	----	----	----	----	----	----	----	----	----	----	----	----	----	----	----	----	----	----	----	----	----	----	----	----	----	-----

PAVIMENTO	MEIO FIO	ESTREIA	MURO	TALUDE	ARVORE	CANTEIRO	CAIXA D'ÁGUA



PREFEITURA MUNICIPAL DE GUARACIABA DO NORTE
 RECUPERAÇÃO DE ESTRADAS VICINAIS NO MUNICÍPIO DE GUARACIABA DO NORTE - E.C.E. - PT 1088270-03
 ESTADQUEAMENTO E PERFIL LONGITUDINAL

1 / 12
 H 1:1000
 V 1:100





0 1000 2000

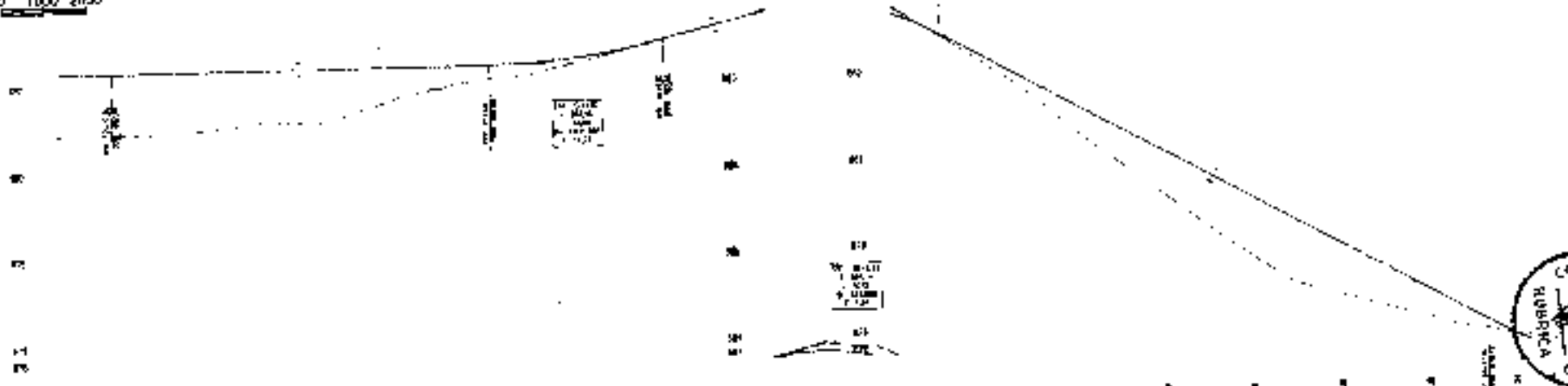

- SINALIZAÇÃO
- PLANTAS
- DRENAGEM
- PAVIMENTO
- TUBOS
- LANTERNAS
- LANTERNAS
- LANTERNAS









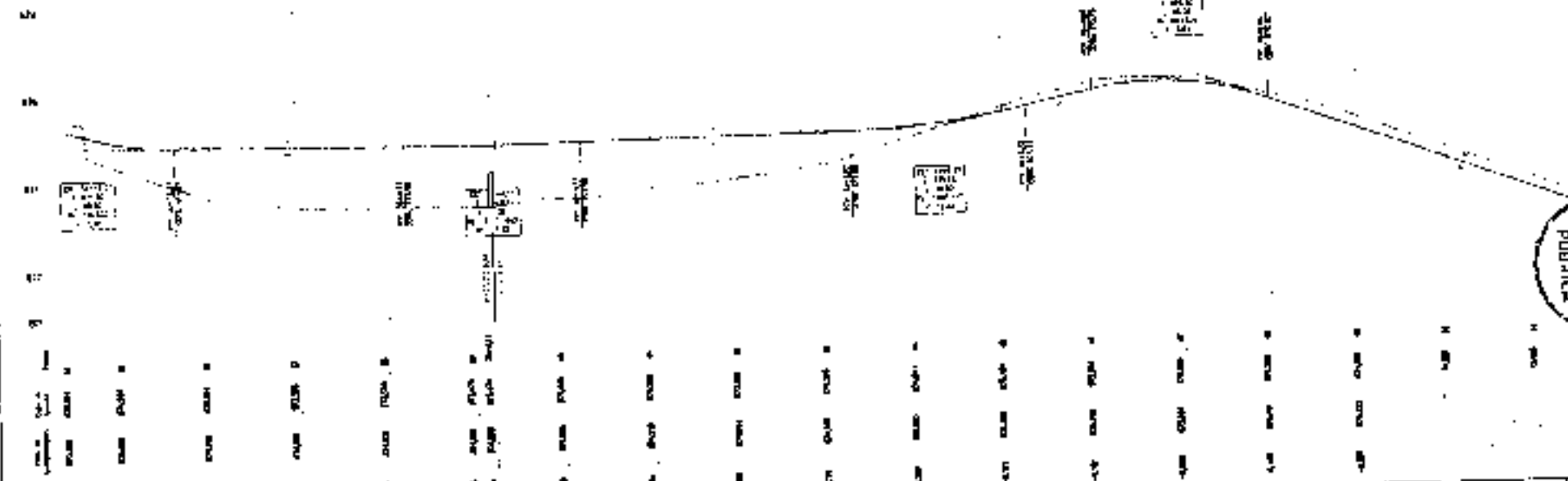

PREFEITURA MUNICIPAL DE GUARACIABA DO NORTE
 RECUPERAÇÃO DE ESTRADAS VICINAIS NO MUNICÍPIO DE GUARACIABA DO NORTE-CE - P1 1066270-00
 ESTAQUEAMENTO E PERFIL LONGITUDINAL
 PROJETO: JOTA BARROS PROJETO
 LOCAL: GUARACIABA DO NORTE-CE

2 / 12
 15.1.1000
 15.1.1000



1:000 2250



- 
CANTO
- 
DRENAGEM
- 
SINALIZACAO
- 
CANTO
- 
DRENAGEM
- 
CANTO
- 
SINALIZACAO
- 
CANTO



PREFEITURA MUNICIPAL DE GUARACIABA DO NORTE
 RECLAMACAO DE ESTRADAS VICINAIS NO MUNICIPIO DE GUARACIABA DO NORTE-CE PT 0002/0-00
 ESTAQUEAMENTO E PERFIL LONGITUDINAL



FOLHA
3 / 12
 ESCALA
 1:10000
 1-100

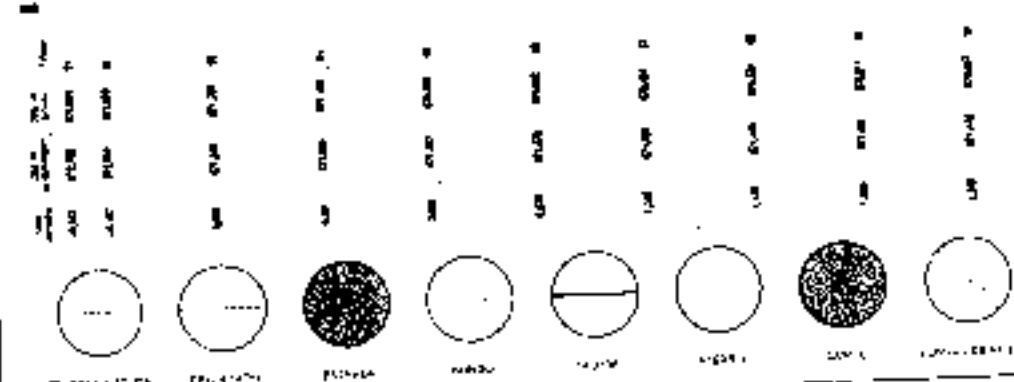
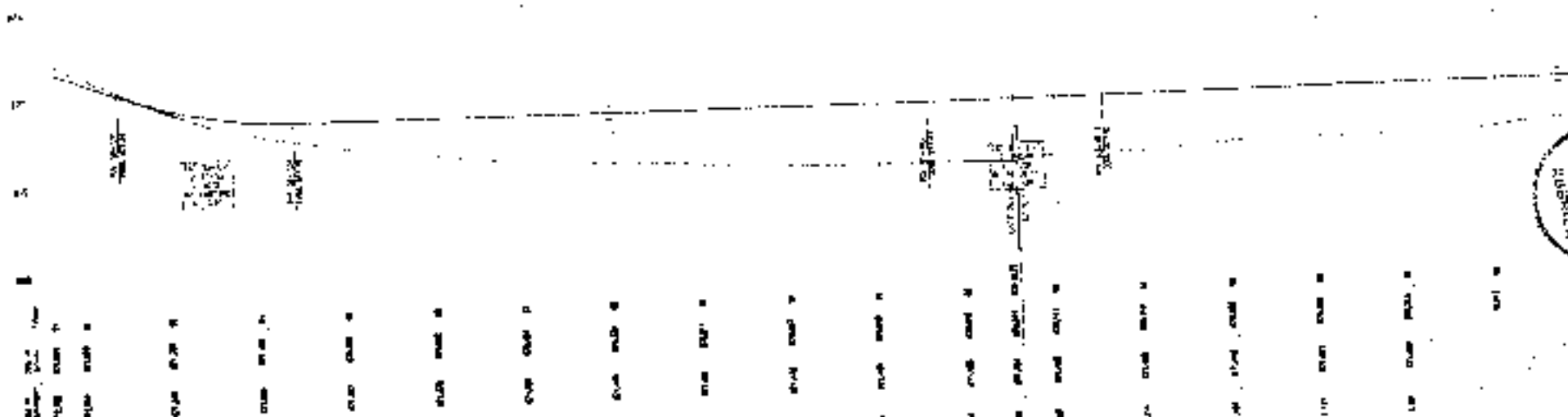

PREFEITURA MUNICIPAL DE GUARACIABÁ DO NORTE	
RECUPERAÇÃO DE ESTRADAS VICINAIS NO MUNICÍPIO DE GUARACIABÁ DO NORTE-CE - PT 108670-00	
ESTADUEAMENTO E PERFIL LONGITUDINAL	
PROJETO	PROJ. DE ESTADUEAMENTO E PERFIL LONGITUDINAL
PROPOSTA	PROPOSTA DE ESTADUEAMENTO E PERFIL LONGITUDINAL





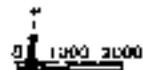



4 / 12
 ESCALA
 H 1:1000
 V 1:100



0
1
2
3
4
5
6
7
8
9
10
11
12
13
14
15
16
17
18
19
20
21
22
23
24
25
26
27
28
29
30
31
32
33
34
35
36
37
38
39
40
41
42
43
44
45
46
47
48
49
50
51
52
53
54
55
56
57
58
59
60
61
62
63
64
65
66
67
68
69
70
71
72
73
74
75
76
77
78
79
80
81
82
83
84
85
86
87
88
89
90
91
92
93
94
95
96
97
98
99
100



-  VARIANTE
-  MURTO
-  CANTO
-  BARRA
-  TUBO
-  ALAR
-  CANTO
-  VARIANTE



PREFEITURA MUNICIPAL DE GUARACIABA DO NORTE	
RECUPERAÇÃO DE ESTRADAS VICINAIS NO MUNICÍPIO DE GUARACIABA DO NORTE-CE - PT 1008270-02	
ESTAQUEAMENTO E PERFIL LONGITUDINAL	
PROJ. CIVIL	JOTA BAMBAS ENGENHARIA
PROJ. ELETR.	JOTA BAMBAS ENGENHARIA

PARTE Nº	5 / 12
ESCALA	H 1:1000 V 1:100

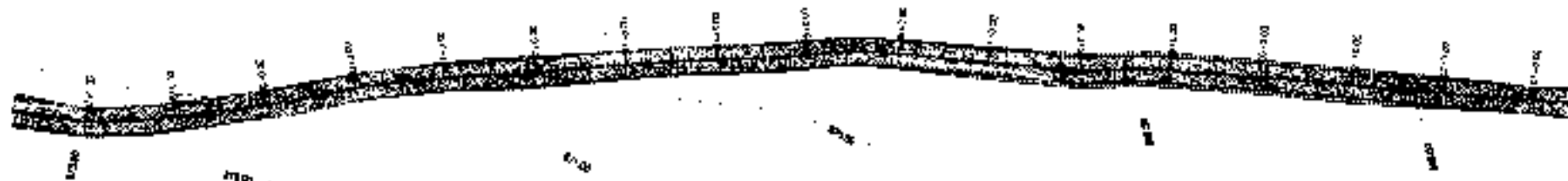
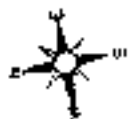

0 1000 2000

1:1000

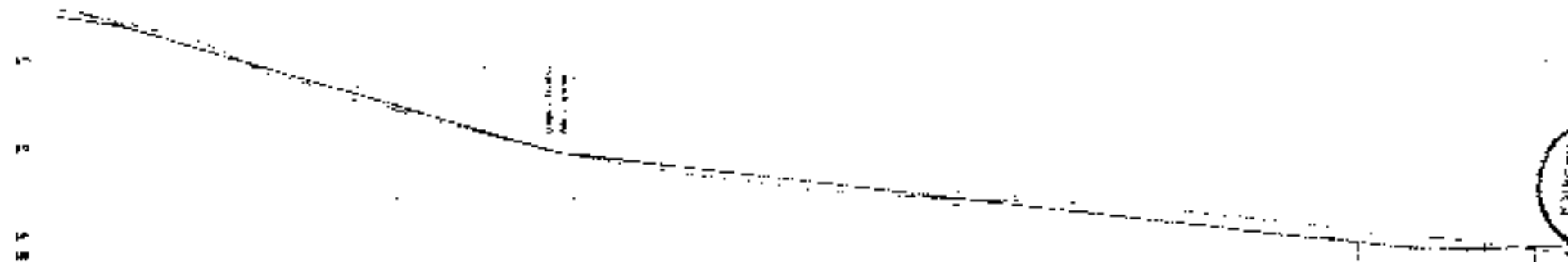

100	150	200	250	300	350	400	450	500	550	600	650	700	750	800	850	900	950	1000
100	150	200	250	300	350	400	450	500	550	600	650	700	750	800	850	900	950	1000
100	150	200	250	300	350	400	450	500	550	600	650	700	750	800	850	900	950	1000

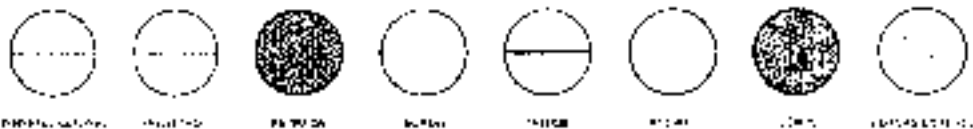

	MUNICÍPIO MUNICIPAL DE GUARACIABA DO NORTE		6 / 12
	RECUPERAÇÃO DE ESTRADAS VICINAIS NO MUNICÍPIO DE GUARACIABA DO NORTE - CE - PT 1086270-02		
	ESTAQUEAMENTO E PERFIL LONGITUDINAL		
ESCALA 1:100	DATA 10/05/2011	PROJ. JOTA BARRAS	11/1000
ANEXO 1	1:100	1:100	1:100

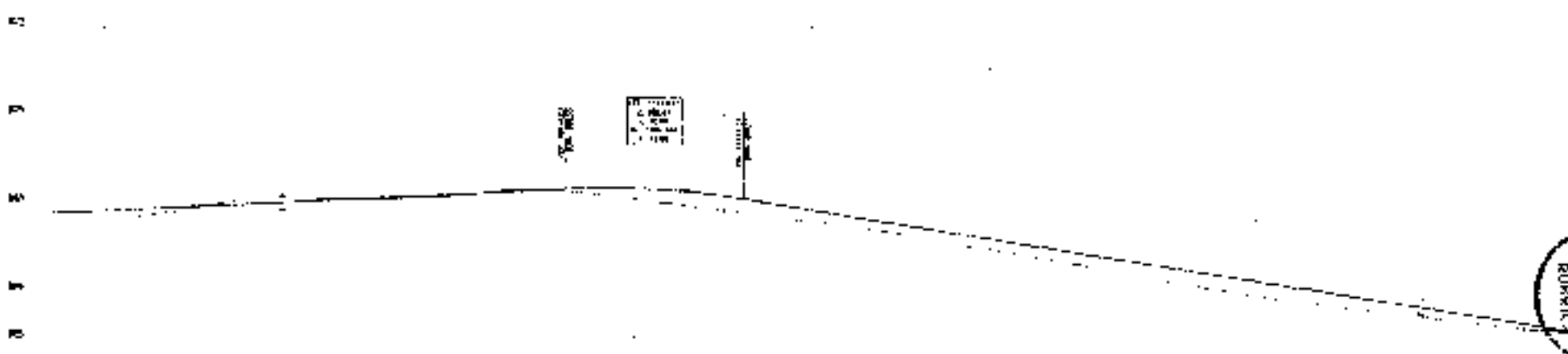

1	2	3	4	5	6	7	8	9	10	11	12	13	14	15	16	17	18	19	20	21	22	23	24	25	26	27	28	29	30	31	32	33	34	35	36	37	38	39	40	41	42	43	44	45	46	47	48	49	50	51	52	53	54	55	56	57	58	59	60	61	62	63	64	65	66	67	68	69	70	71	72	73	74	75	76	77	78	79	80	81	82	83	84	85	86	87	88	89	90	91	92	93	94	95	96	97	98	99	100																																																																																																																																																																																																																																																																																																													
0+00	0+25	0+50	0+75	1+00	1+25	1+50	1+75	2+00	2+25	2+50	2+75	3+00	3+25	3+50	3+75	4+00	4+25	4+50	4+75	5+00	5+25	5+50	5+75	6+00	6+25	6+50	6+75	7+00	7+25	7+50	7+75	8+00	8+25	8+50	8+75	9+00	9+25	9+50	9+75	10+00	10+25	10+50	10+75	11+00	11+25	11+50	11+75	12+00	12+25	12+50	12+75	13+00	13+25	13+50	13+75	14+00	14+25	14+50	14+75	15+00	15+25	15+50	15+75	16+00	16+25	16+50	16+75	17+00	17+25	17+50	17+75	18+00	18+25	18+50	18+75	19+00	19+25	19+50	19+75	20+00	20+25	20+50	20+75	21+00	21+25	21+50	21+75	22+00	22+25	22+50	22+75	23+00	23+25	23+50	23+75	24+00	24+25	24+50	24+75	25+00	25+25	25+50	25+75	26+00	26+25	26+50	26+75	27+00	27+25	27+50	27+75	28+00	28+25	28+50	28+75	29+00	29+25	29+50	29+75	30+00	30+25	30+50	30+75	31+00	31+25	31+50	31+75	32+00	32+25	32+50	32+75	33+00	33+25	33+50	33+75	34+00	34+25	34+50	34+75	35+00	35+25	35+50	35+75	36+00	36+25	36+50	36+75	37+00	37+25	37+50	37+75	38+00	38+25	38+50	38+75	39+00	39+25	39+50	39+75	40+00	40+25	40+50	40+75	41+00	41+25	41+50	41+75	42+00	42+25	42+50	42+75	43+00	43+25	43+50	43+75	44+00	44+25	44+50	44+75	45+00	45+25	45+50	45+75	46+00	46+25	46+50	46+75	47+00	47+25	47+50	47+75	48+00	48+25	48+50	48+75	49+00	49+25	49+50	49+75	50+00	50+25	50+50	50+75	51+00	51+25	51+50	51+75	52+00	52+25	52+50	52+75	53+00	53+25	53+50	53+75	54+00	54+25	54+50	54+75	55+00	55+25	55+50	55+75	56+00	56+25	56+50	56+75	57+00	57+25	57+50	57+75	58+00	58+25	58+50	58+75	59+00	59+25	59+50	59+75	60+00	60+25	60+50	60+75	61+00	61+25	61+50	61+75	62+00	62+25	62+50	62+75	63+00	63+25	63+50	63+75	64+00	64+25	64+50	64+75	65+00	65+25	65+50	65+75	66+00	66+25	66+50	66+75	67+00	67+25	67+50	67+75	68+00	68+25	68+50	68+75	69+00	69+25	69+50	69+75	70+00	70+25	70+50	70+75	71+00	71+25	71+50	71+75	72+00	72+25	72+50	72+75	73+00	73+25	73+50	73+75	74+00	74+25	74+50	74+75	75+00	75+25	75+50	75+75	76+00	76+25	76+50	76+75	77+00	77+25	77+50	77+75	78+00	78+25	78+50	78+75	79+00	79+25	79+50	79+75	80+00	80+25	80+50	80+75	81+00	81+25	81+50	81+75	82+00	82+25	82+50	82+75	83+00	83+25	83+50	83+75	84+00	84+25	84+50	84+75	85+00	85+25	85+50	85+75	86+00	86+25	86+50	86+75	87+00	87+25	87+50	87+75	88+00	88+25	88+50	88+75	89+00	89+25	89+50	89+75	90+00	90+25	90+50	90+75	91+00	91+25	91+50	91+75	92+00	92+25	92+50	92+75	93+00	93+25	93+50	93+75	94+00	94+25	94+50	94+75	95+00	95+25	95+50	95+75	96+00	96+25	96+50	96+75	97+00	97+25	97+50	97+75	98+00	98+25	98+50	98+75	99+00	99+25	99+50	99+75	100+00

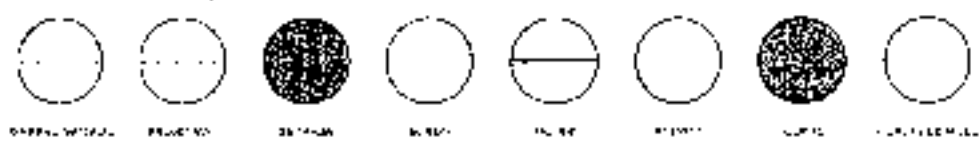

	PREFEITURA MUNICIPAL DE GUARACIABA DO NORTE RECUPERAÇÃO DE ESTRADAS VICINAIS NO MUNICÍPIO DE GUARACIABA DO NORTE-CE - PT 106270-03		Nº 112
	ESTAQUEAMENTO E PERFIL LONGITUDINAL		ESCALA H: 1:1000 V: 1:100
	DATA:	LOCAL:	PROJETO:





0 1000 2000

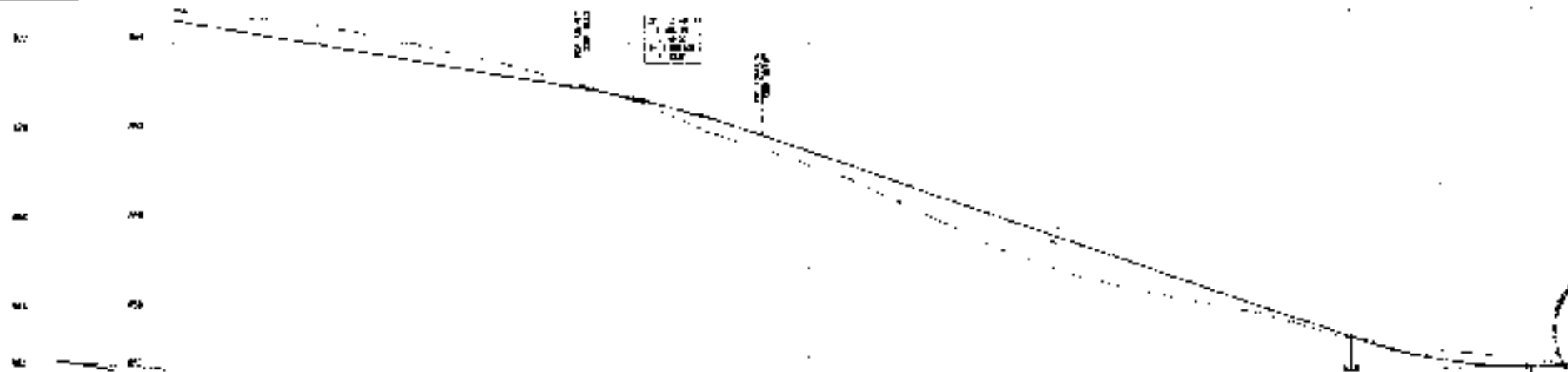

Est.	0+00	0+10	0+20	0+30	0+40	0+50	0+60	0+70	0+80	0+90	1+00	1+10	1+20	1+30	1+40	1+50	1+60	1+70	1+80	1+90	2+00
Alt. (m)	100	105	110	115	120	125	130	135	140	145	150	155	160	165	170	175	180	185	190	195	200
Alt. (m)	100	105	110	115	120	125	130	135	140	145	150	155	160	165	170	175	180	185	190	195	200
Alt. (m)	100	105	110	115	120	125	130	135	140	145	150	155	160	165	170	175	180	185	190	195	200

PAVIMENTO	FAIXA DE	DRENAÇÃO	MEDIAN	FAIXA DE	ÁREA	LOTE	FAIXA DE



PREFEITURA MUNICIPAL DE GUARACIABA DO NORTE
 RECUPERAÇÃO DE ESTRADAS VICINAIS NO MUNICÍPIO DE GUARACIABA DO NORTE-CE - FT 1386270-03
 ESTAQUEAMENTO E PERFIL LONGITUDINAL



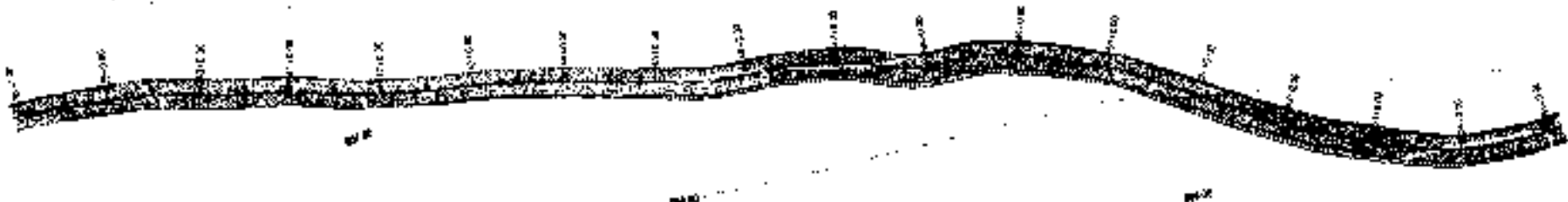

8 / 12
 H 1 1000
 V 1-100

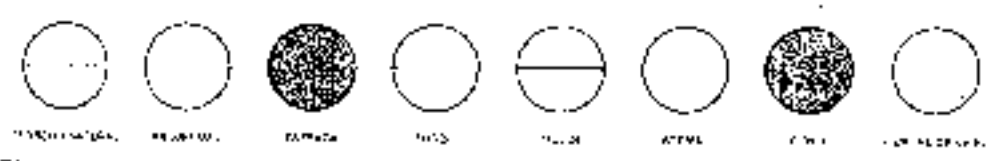
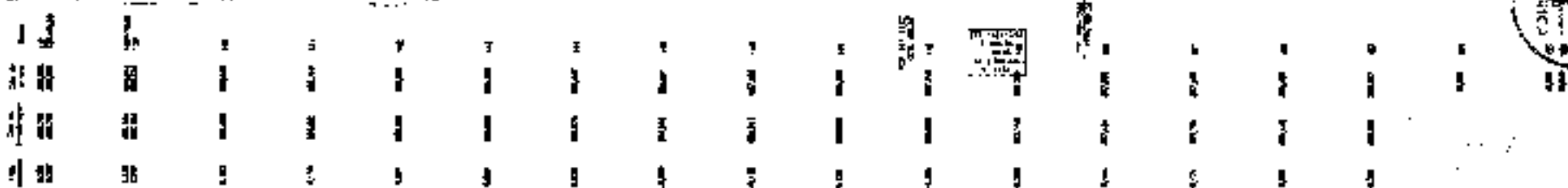

1:1000 2000

0
1
2
3
4
5
6
7
8
9
10
11
12
13
14
15
16
17
18
19
20
21
22
23
24
25
26
27
28
29
30
31
32
33
34
35
36
37
38
39
40
41
42
43
44
45
46
47
48
49
50
51
52
53
54
55
56
57
58
59
60
61
62
63
64
65
66
67
68
69
70
71
72
73
74
75
76
77
78
79
80
81
82
83
84
85
86
87
88
89
90
91
92
93
94
95
96
97
98
99
100



	PREFEITURA MUNICIPAL DE GUARACIABA DO NORTE		RINTE
	REGENERAÇÃO DE ESTRADAS VICINAIS NO MUNICÍPIO DE GUARACIABA DO NORTE - CF - PT 108270-03		9 / 12
	ESTAQUEAMENTO E PERFIL LONGITUDINAL		ESCALA H 1:1000 V 1:100
DATA:	FOLHA:	PROJETO:	TÍTULO:



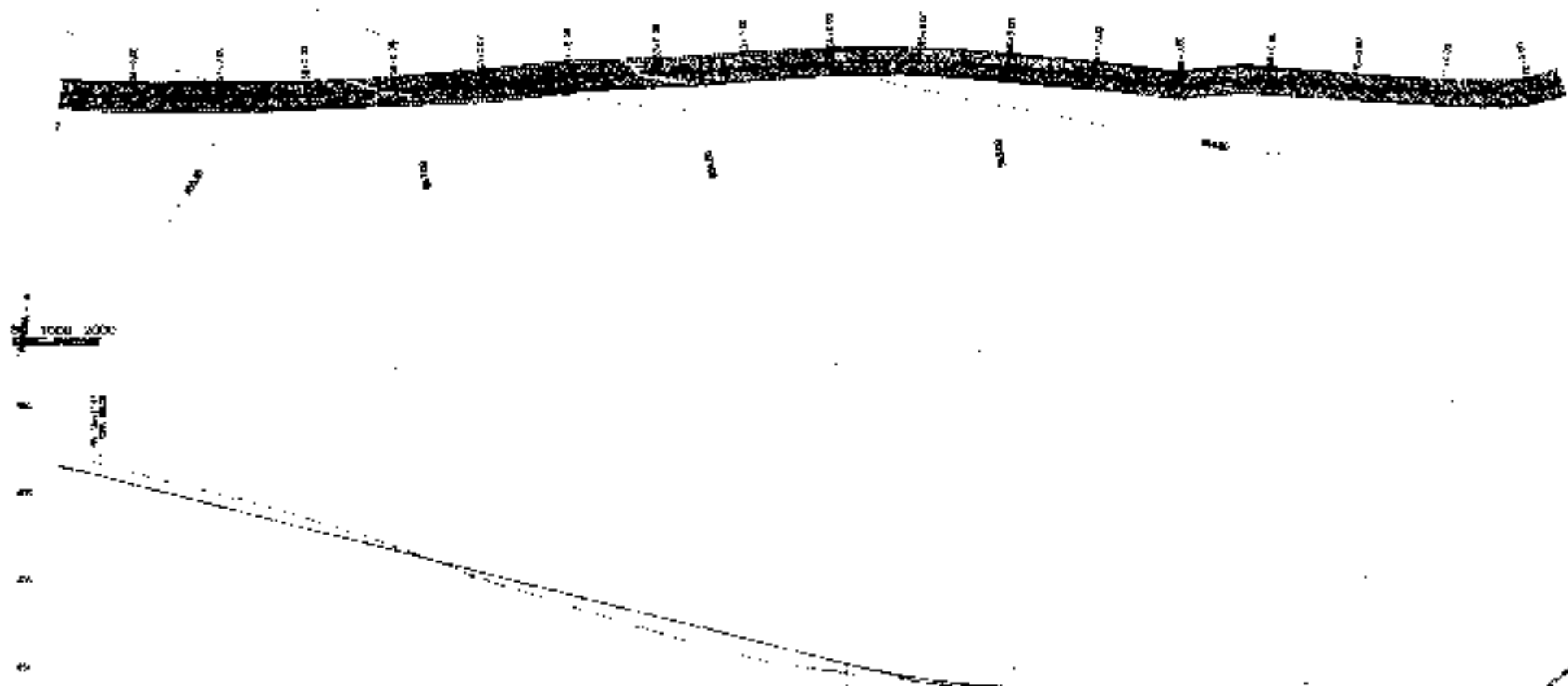

1000 2000

1000 2000

1	2	3	4	5	6	7	8	9	10	11	12	13	14	15	16	17	18	19	20	21	22	23	24	25	26	27	28	29	30	31	32	33	34	35	36	37	38	39	40	41	42	43	44	45	46	47	48	49	50	51	52	53	54	55	56	57	58	59	60	61	62	63	64	65	66	67	68	69	70	71	72	73	74	75	76	77	78	79	80	81	82	83	84	85	86	87	88	89	90	91	92	93	94	95	96	97	98	99	100
1000	1100	1200	1300	1400	1500	1600	1700	1800	1900	2000	2100	2200	2300	2400	2500	2600	2700	2800	2900	3000	3100	3200	3300	3400	3500	3600	3700	3800	3900	4000	4100	4200	4300	4400	4500	4600	4700	4800	4900	5000	5100	5200	5300	5400	5500	5600	5700	5800	5900	6000	6100	6200	6300	6400	6500	6600	6700	6800	6900	7000	7100	7200	7300	7400	7500	7600	7700	7800	7900	8000	8100	8200	8300	8400	8500	8600	8700	8800	8900	9000	9100	9200	9300	9400	9500	9600	9700	9800	9900	10000									

1000	1100	1200	1300	1400	1500	1600	1700	1800



PREFEITURA MUNICIPAL DE GIARACIABA DO NORTE
 RECUPERAÇÃO DE ESTRADAS VICINAIS NO MUNICÍPIO DE GIARACIABA DO NORTE-CE - PT 1086270-03
 ESTADQUEAMENTO E PERFIL LONGITUDINAL



10 / 12
 H 1/1000
 V 1/100

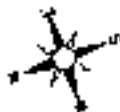

0 1000 2000

0 5 10 15 20 25 30 35 40 45 50 55 60 65 70 75 80 85 90 95 100



TERRELAÇÃO



PAVIMENTO



PIEDRA



ALCALI



ALCALI



ALCALI



ALCALI



ALCALI



PREFEITURA MUNICIPAL DE GUARALHARA DO NORTE
RECUPERAÇÃO DE ESTRADAS VICINAIS NO MUNICÍPIO DE GUARALHARA DO NORTE-CE - PI : 08270-03

ESTADAMENTO E PERFIL LONGITUDINAL
PROJETO DE RECONSTRUÇÃO DE ESTRADAS VICINAIS

11 / 12
ESCALA
H 1:1000
V 1:100





0 1000 2000

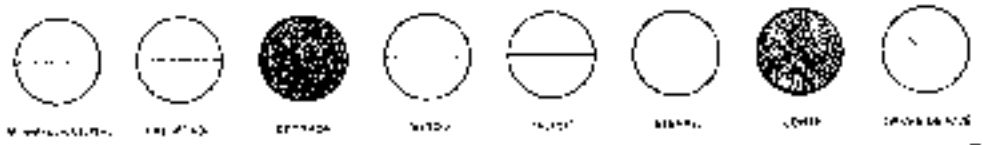
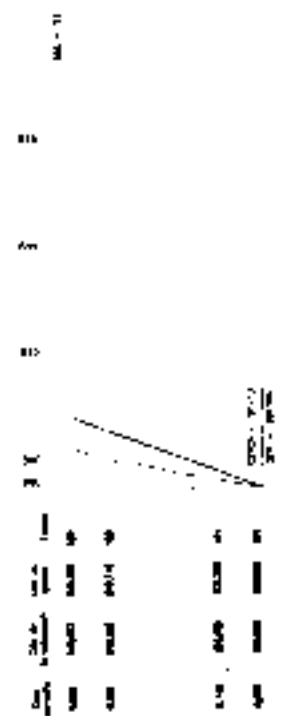



PREFEITURA MUNICIPAL DE GUARACIUBA DO NORTE	
RECUPERAÇÃO DE ESTRADAS VICINAIS NO MUNICÍPIO DE GUARACIUBA DO NORTE - PT. 1180270-03	
ESTAQUEAMENTO E PERFIL LONGITUDINAL	
PROJETO	PROJ. QUANTITATIVO DE MATERIAIS E OBRAS DE OBRAS
ARQUITETO	PROJ. CIVIL - ENGENH. CIVIL - ENGENH. CIVIL

DATA	12 / 12
ESCALA	H=1:1000 V=1:100

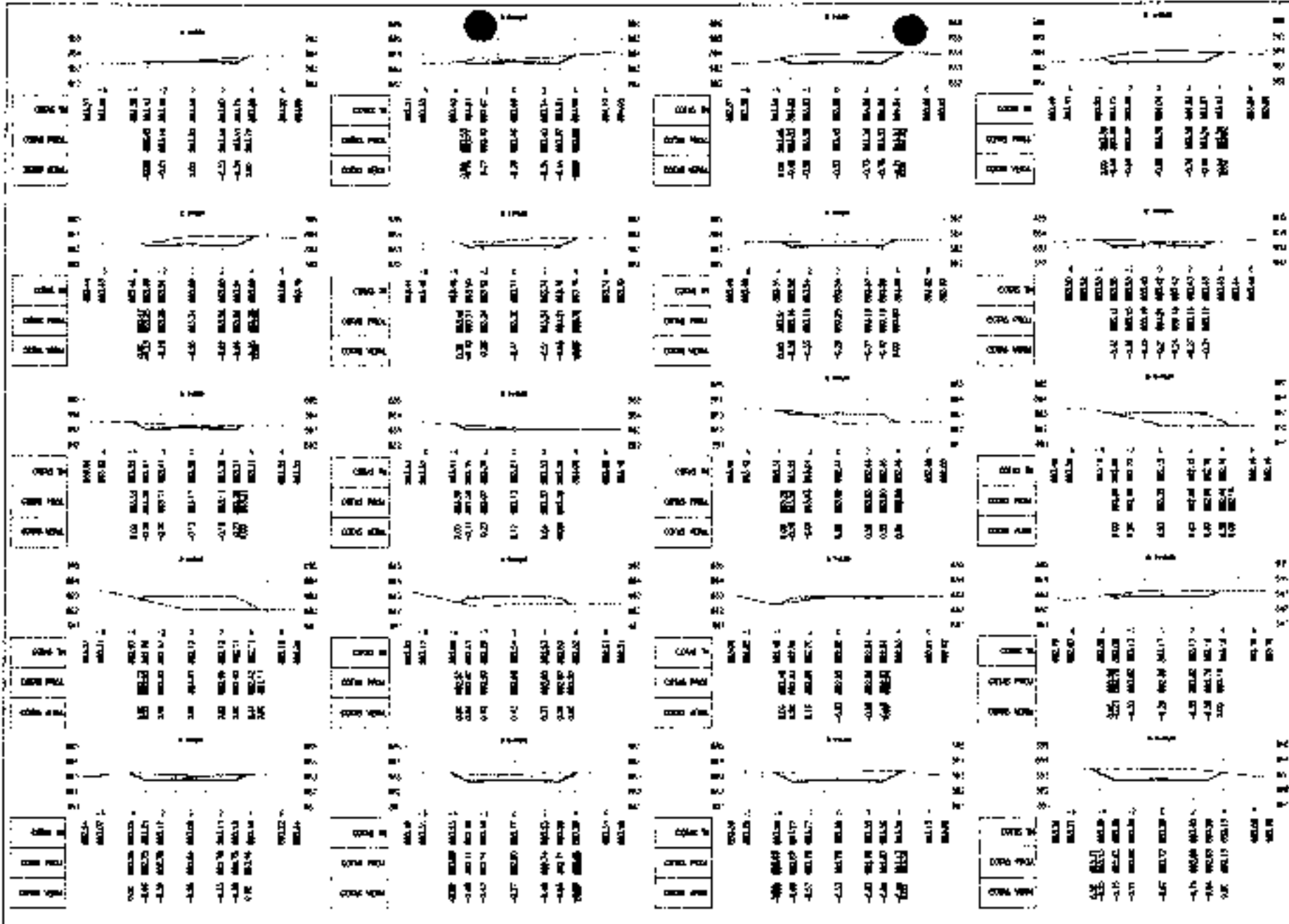



LEGENDA

-  ATERRADO
-  CORTE

	PREFEITURA MUNICIPAL DE GUARACIABA DO NORTE REQUERIMENTO DE ESTRADAS VICINAIS NO MUNICÍPIO DE GUARACIABA DO NORTE-CE - PT 1086270-03 SEÇÕES TRANSVERSAIS		FOLHA Nº 1 / 20
	PROPOSTA Nº 002/2011, ANEXAMENTO Nº 01/2011	DATA 10/03/2011	ESCALA 1:250
	LOCAL FORTALEZA FORTALEZA, 027 Km.		



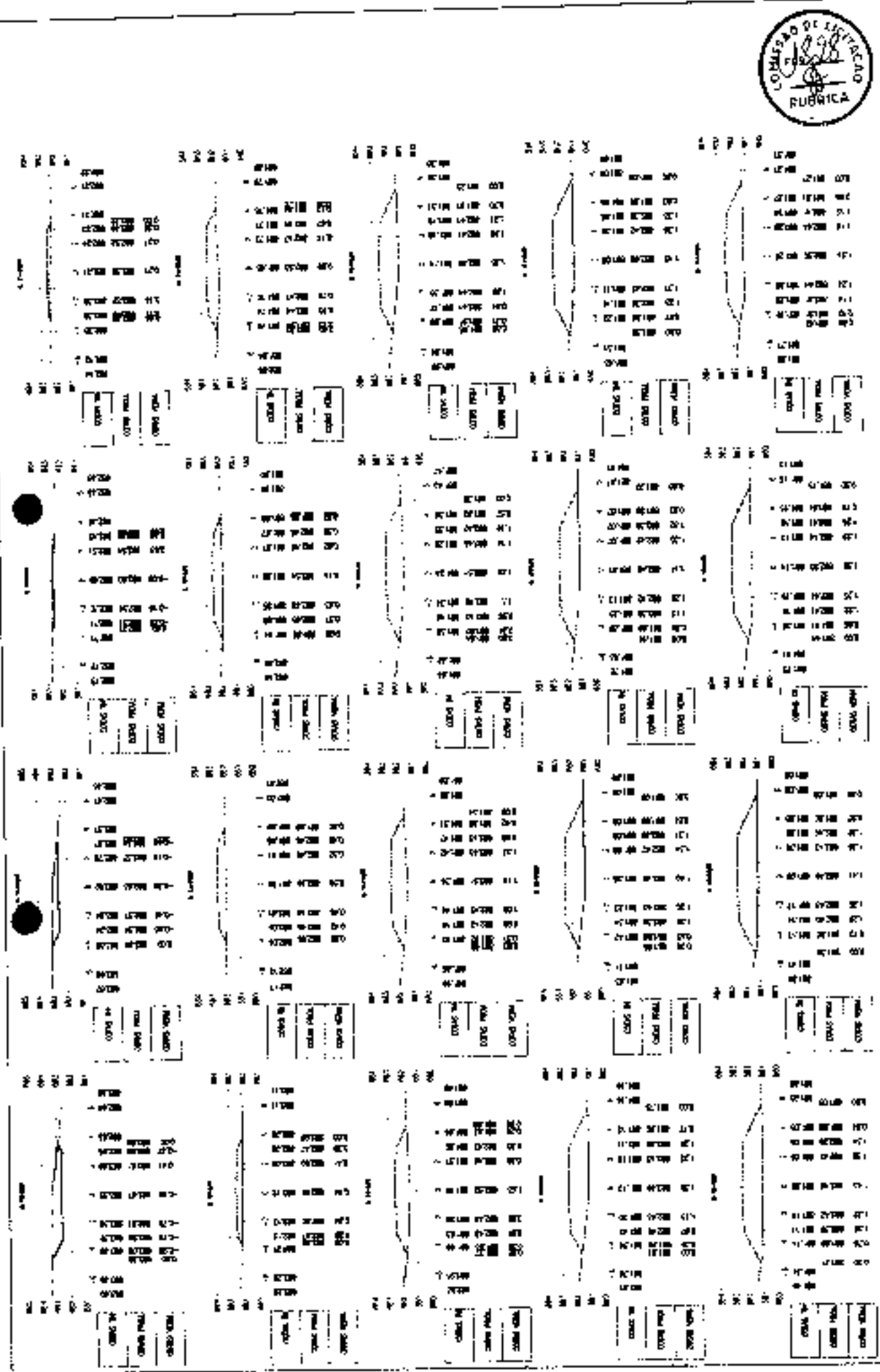

PREFEITURA MUNICIPAL DE GUARALUPA DO NORTE
 RECUPERAÇÃO DE ESTRADAS VICINAS AO MUNICÍPIO DE GUARALUPA
 (AO NORTE-CE - FT. 106627073)
 SEÇÕES TRANSVERSAIS
 Nº 106627073
 Nº 106627073



LEGENDA:
 ATENÇÃO
 CORTE

2 / 20
 106627073

LEGENDA

- ATERRO
- CORTE



PREFEITURA MUNICIPAL DE GUARACIABA DO NORTE		PARCELAS
RECUPERAÇÃO DE ESTRADAS VICINAIS NO MUNICÍPIO DE GUARACIABA DO NORTE-CE - PT 1086270-00		3 / 20
SEÇÕES TRANSVERSAIS		ESTADO
PROJ. CIVIL	PROJ. DE ALTERNATIVAS DE PROJ. DE RECUPERAÇÃO	1/250
PROJ. EXECUTIVO	PROJ. EXECUTIVO DE RECUPERAÇÃO DE ESTRADAS VICINAIS	

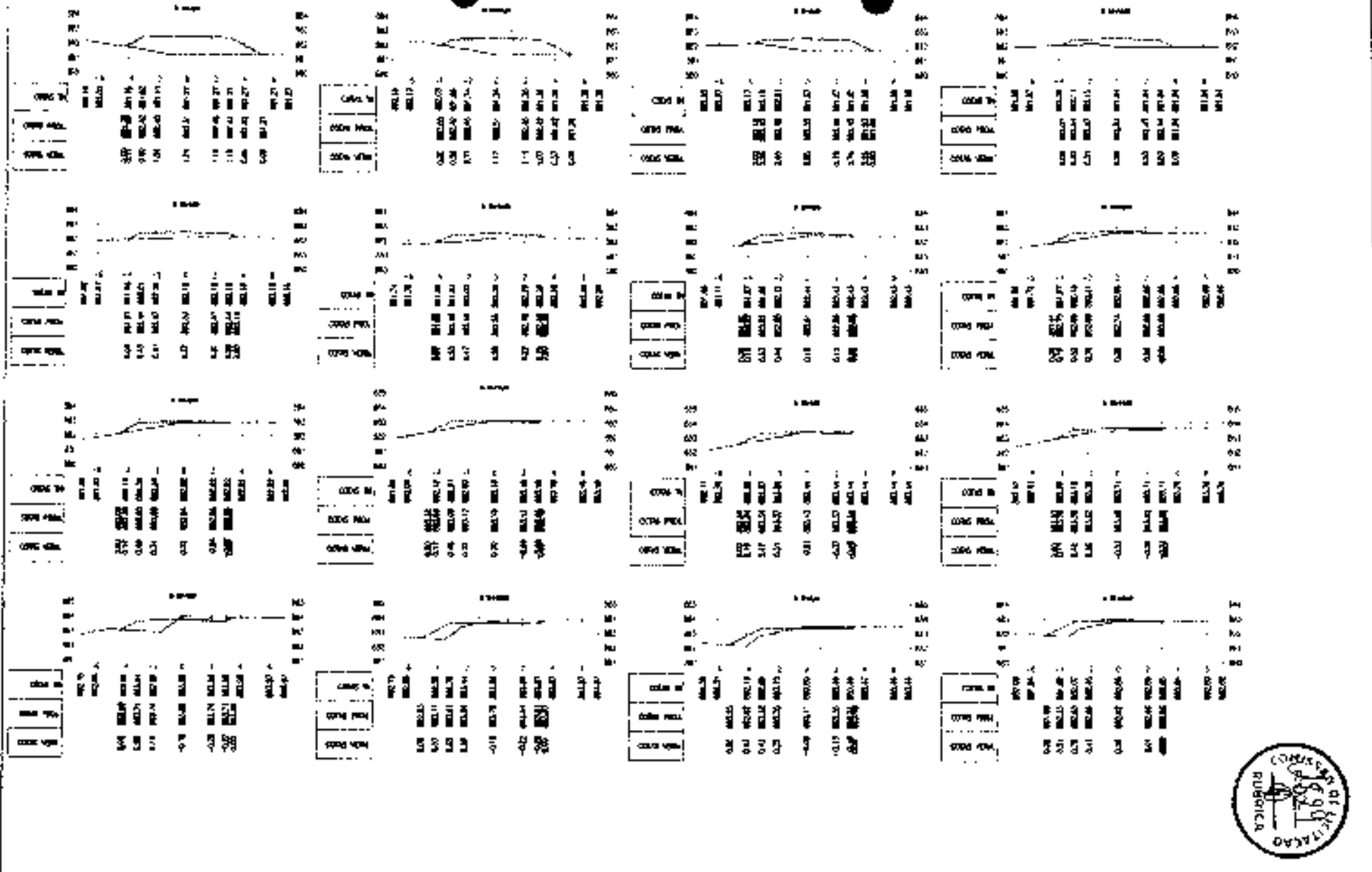

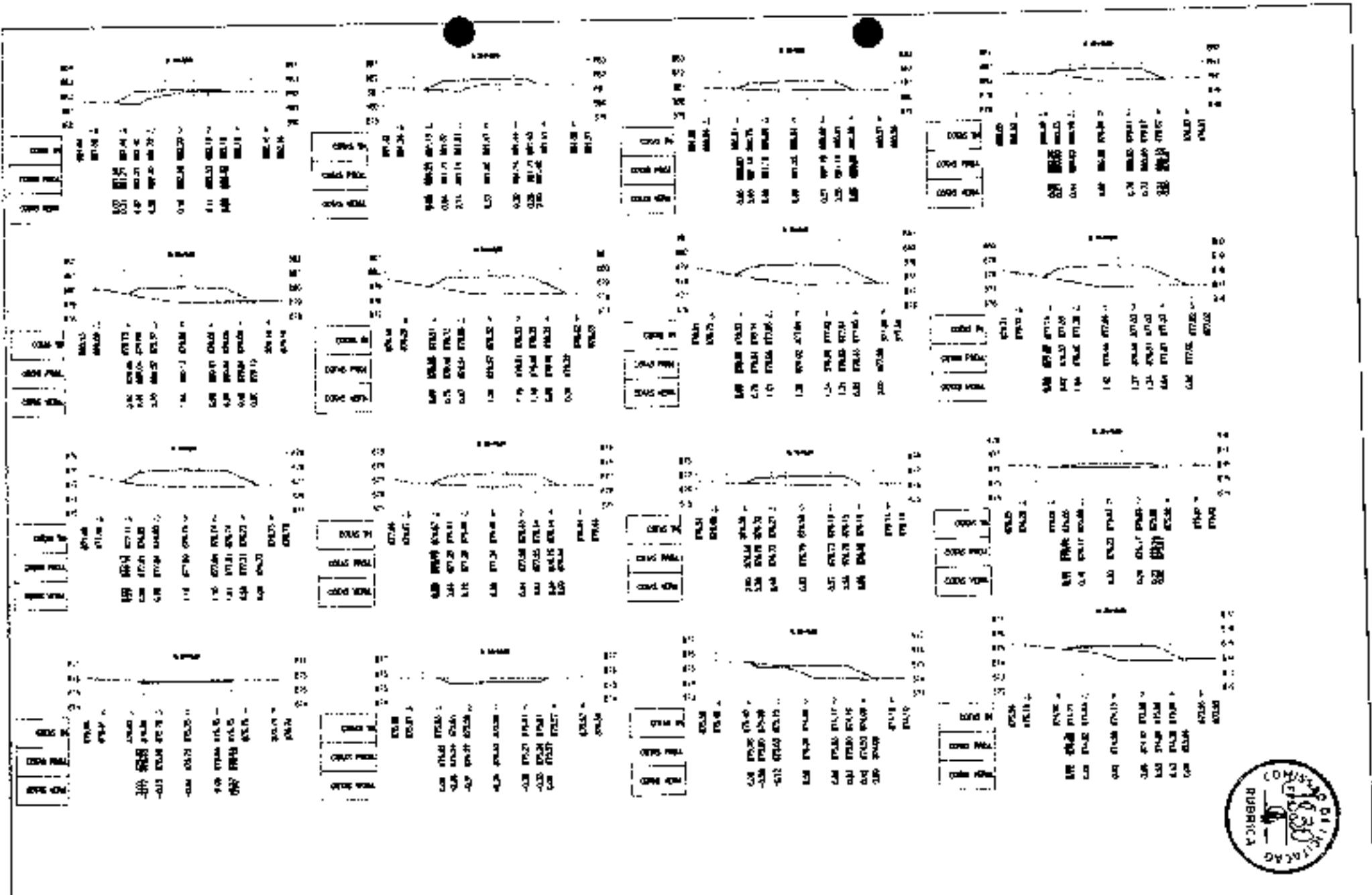

LEGENÇA:
 ATERRO
 CORTE



 NOTA SARRÓS ENGENHARIA	PREFEITURA MUNICIPAL DE GUARACIABA DO NORTE RECUPERAÇÃO DE ESTRADAS VICINAIS NO MUNICÍPIO DE GUARACIABA DO NORTE - CE - PT 1086270-03 SEÇÕES TRANSVERSAIS		FOLHA 4 / 20
	PROJETO:		DATA:
	LOCAL:		ESCALA:

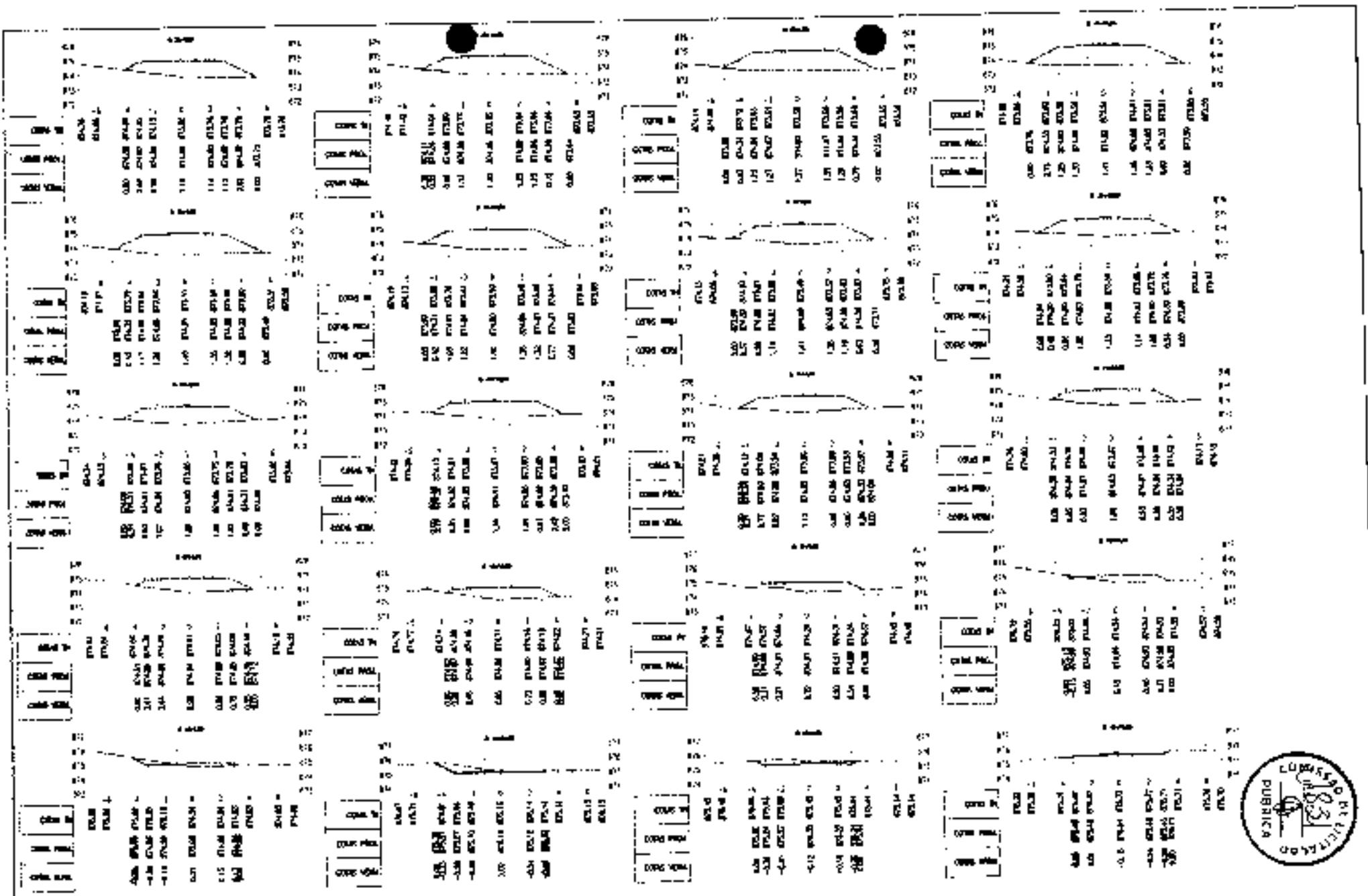

LEGENDA:

 ATERRO

 CORTE



PREFEITURA MUNICIPAL DE GUARACIARA DO NORTE RECUPERAÇÃO DE ESTRADAS VICINAIS NO MUNICÍPIO DE GUARACIARA DO NORTE-CE - PT 1086270-03 SEÇÕES TRANSVERSAIS		Nº 5 / 20 Escala 1:250
PLANO Nº FOLHA Nº	INSC. Nº DATA	1:250



LEGENDA

-  ATERRO
-  CORTE

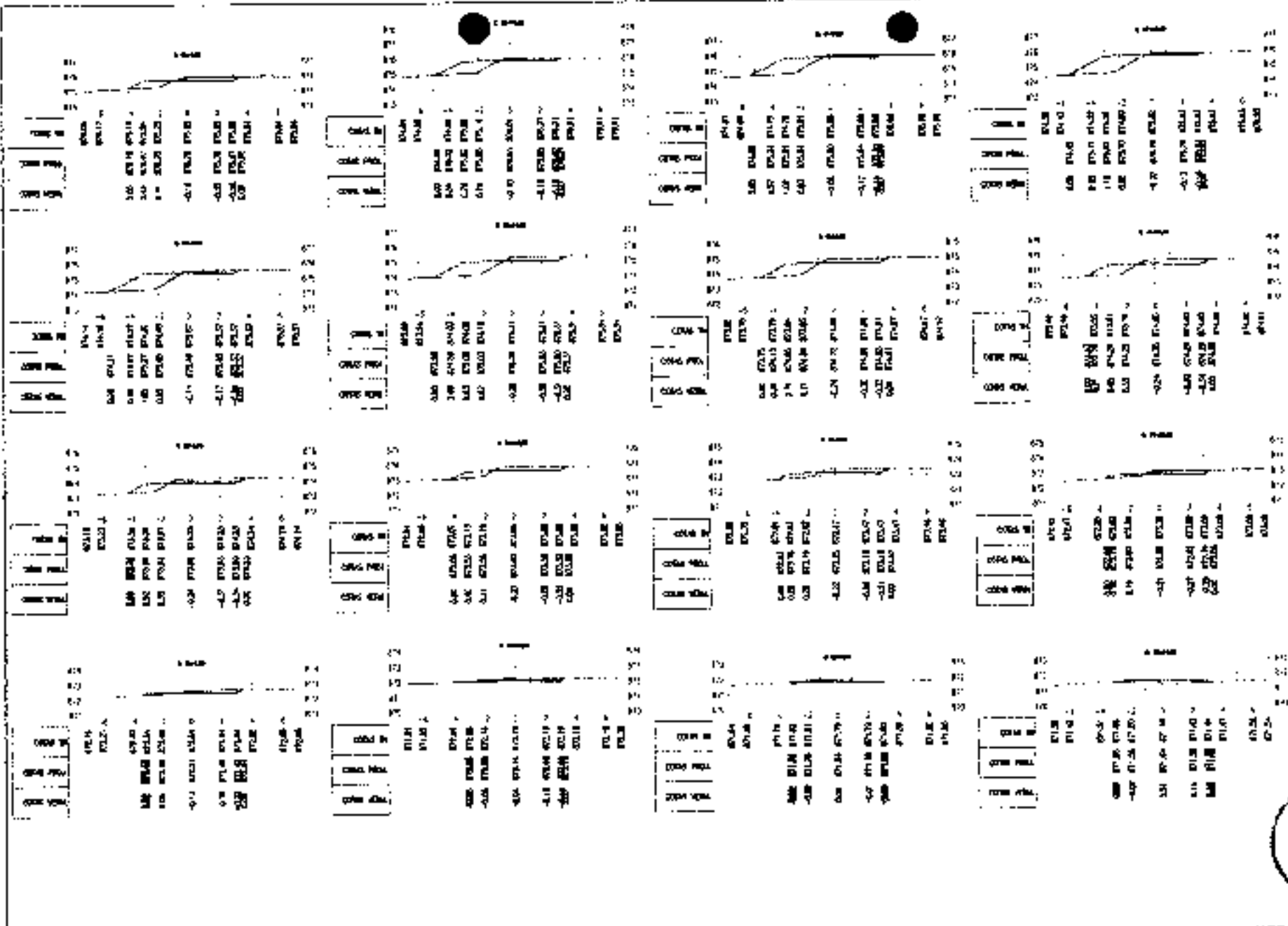

PREFEITURA MUNICIPAL DE GUARACIABA DO NORTE
 RECUPERAÇÃO DE ESTRADAS VICINAIS NO MUNICÍPIO DE GUARACIABA DO NORTE-CE - PT 1086270-03
 SEÇÕES TRANSVERSAIS



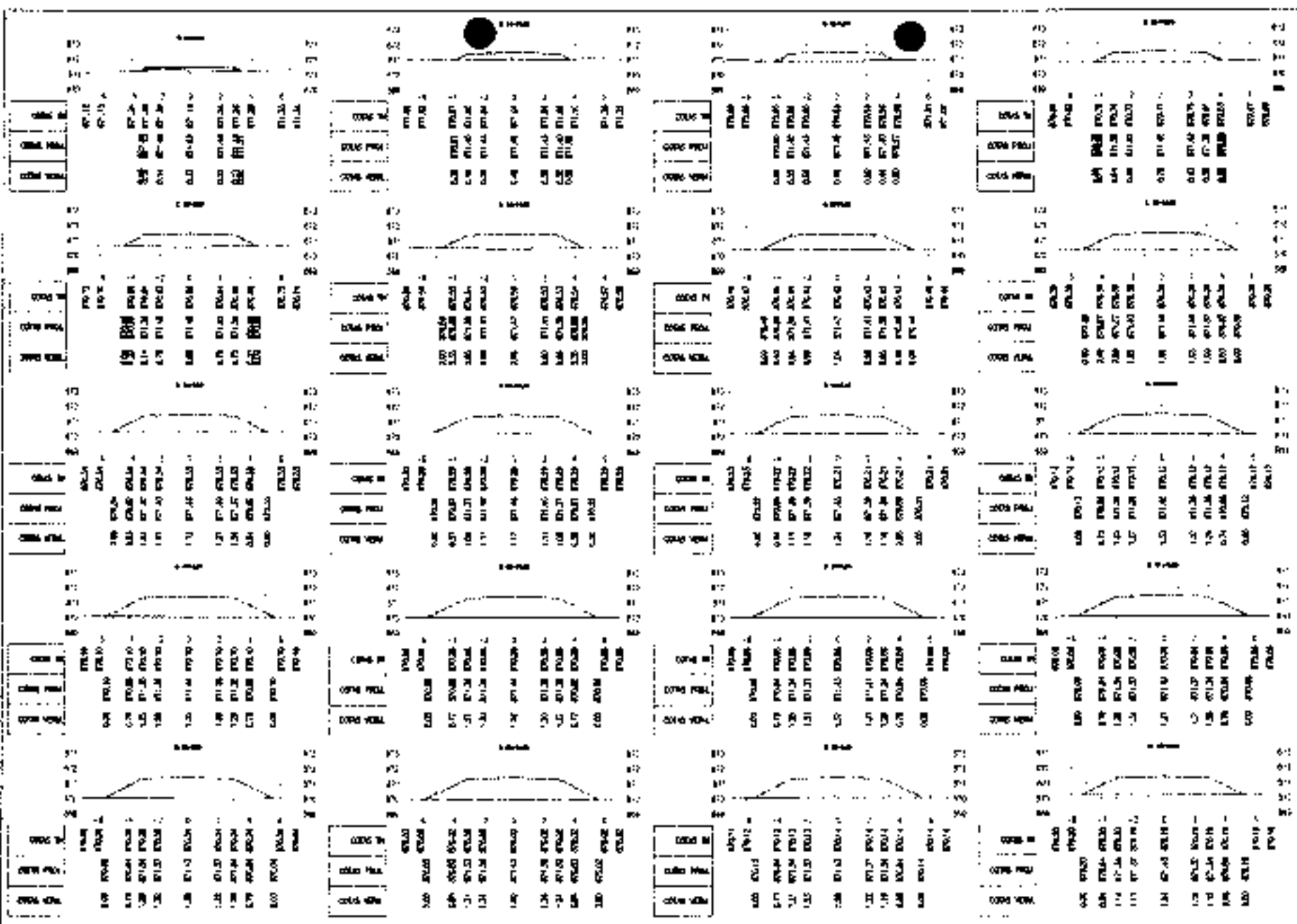

LEGENDA

ATERRO

CORTE



PREFEITURA MUNICIPAL DE GUARACIABA DO NORTE

RECUPERAÇÃO DE ESTRADAS VICIAIS NO MUNICÍPIO DE GUARACIABA DO NORTE-CE - PT 1086270-03

SEÇÕES TRANSVERSAIS

PROJETO DE ARQUITETURA E LAYOUT

PROJETO DE ENGENHARIA DE TRÁFICO



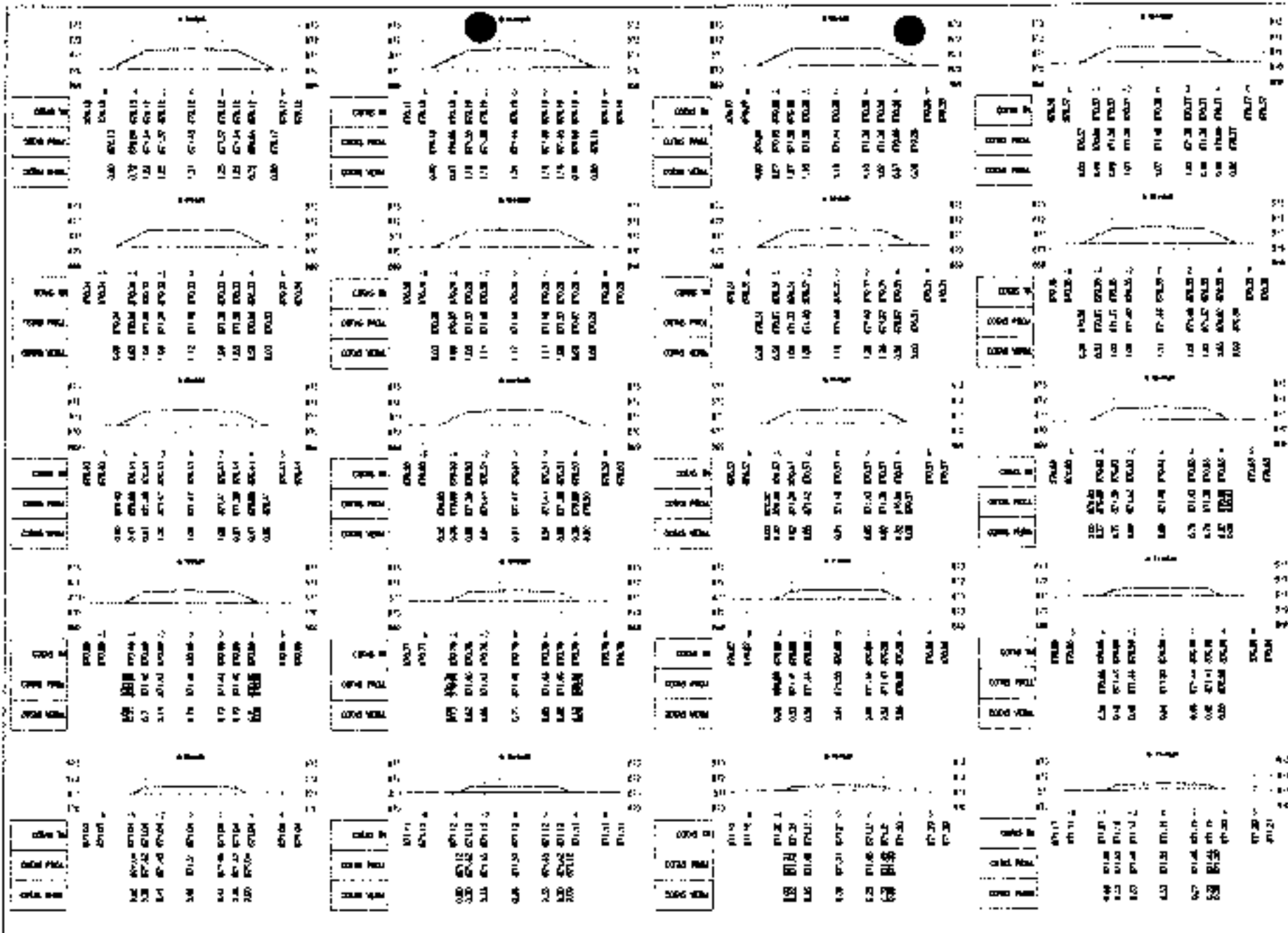

7 / 20

1:250



LEGENDA:

 ATERRO

 CORTE



PREFEITURA MUNICIPAL DE GUARACIABA DO NORTE

RECUPERAÇÃO DE ESTRADAS VICINAIS NO MUNICÍPIO DE GUARACIABA DO NORTE-CE - PI 10862/20-03

SEÇÕES TRANSVERSAIS

Projeto de Engenharia Civil

Autores: [Illegible]

Escala: [Illegible]



8 / 20

1:250

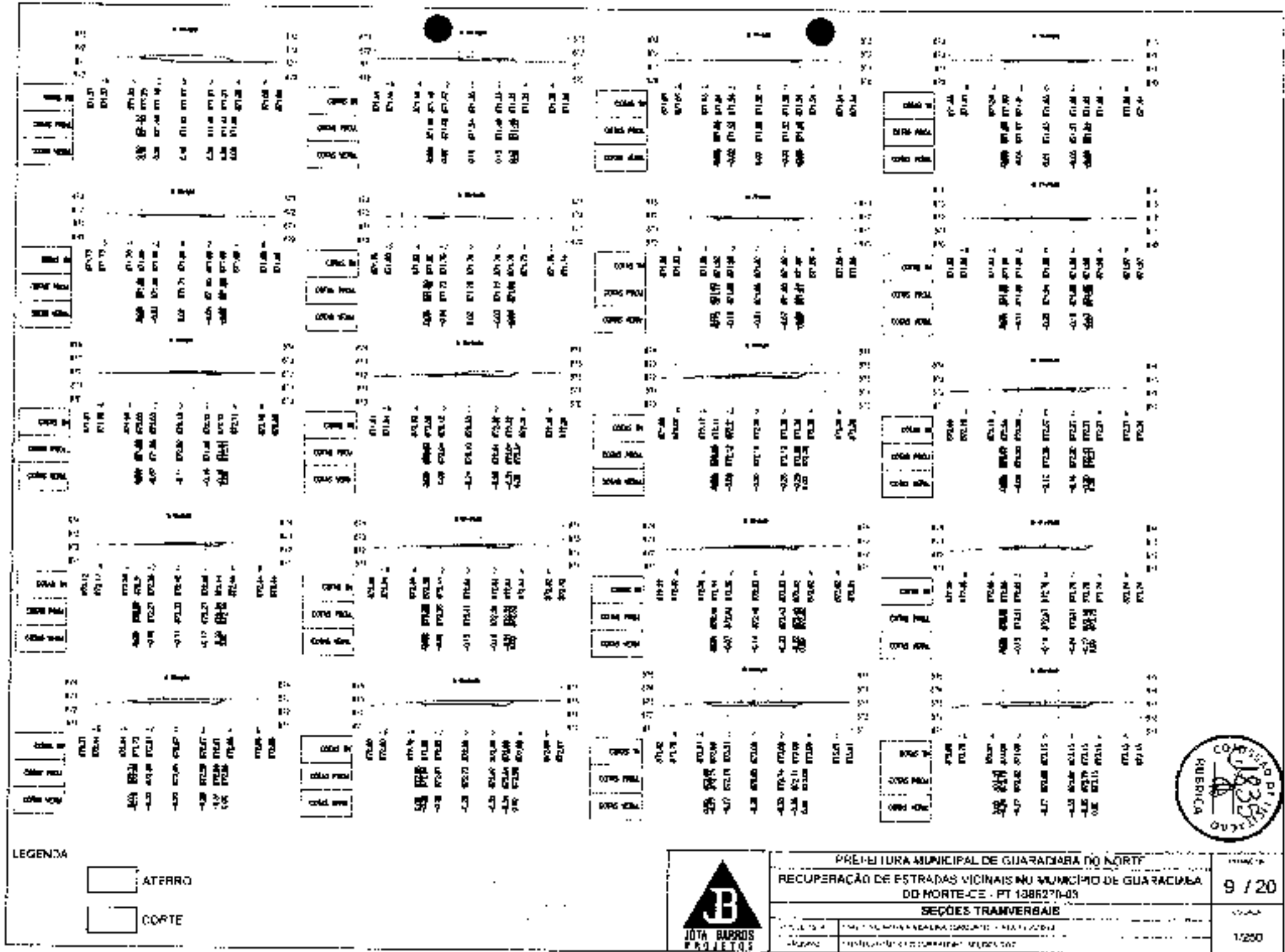

LEGENDA

-  ATERRO
-  CORTE



PREFETURA MUNICIPAL DE GUARAIARÁ DO NORTE
 RECUPERAÇÃO DE ESTRADAS VICINAIS NO MUNICÍPIO DE GUARAIARÁ DO NORTE-CE - PT 1388270-03
 SEÇÕES TRANSVERSAIS

9 / 20
 1/250



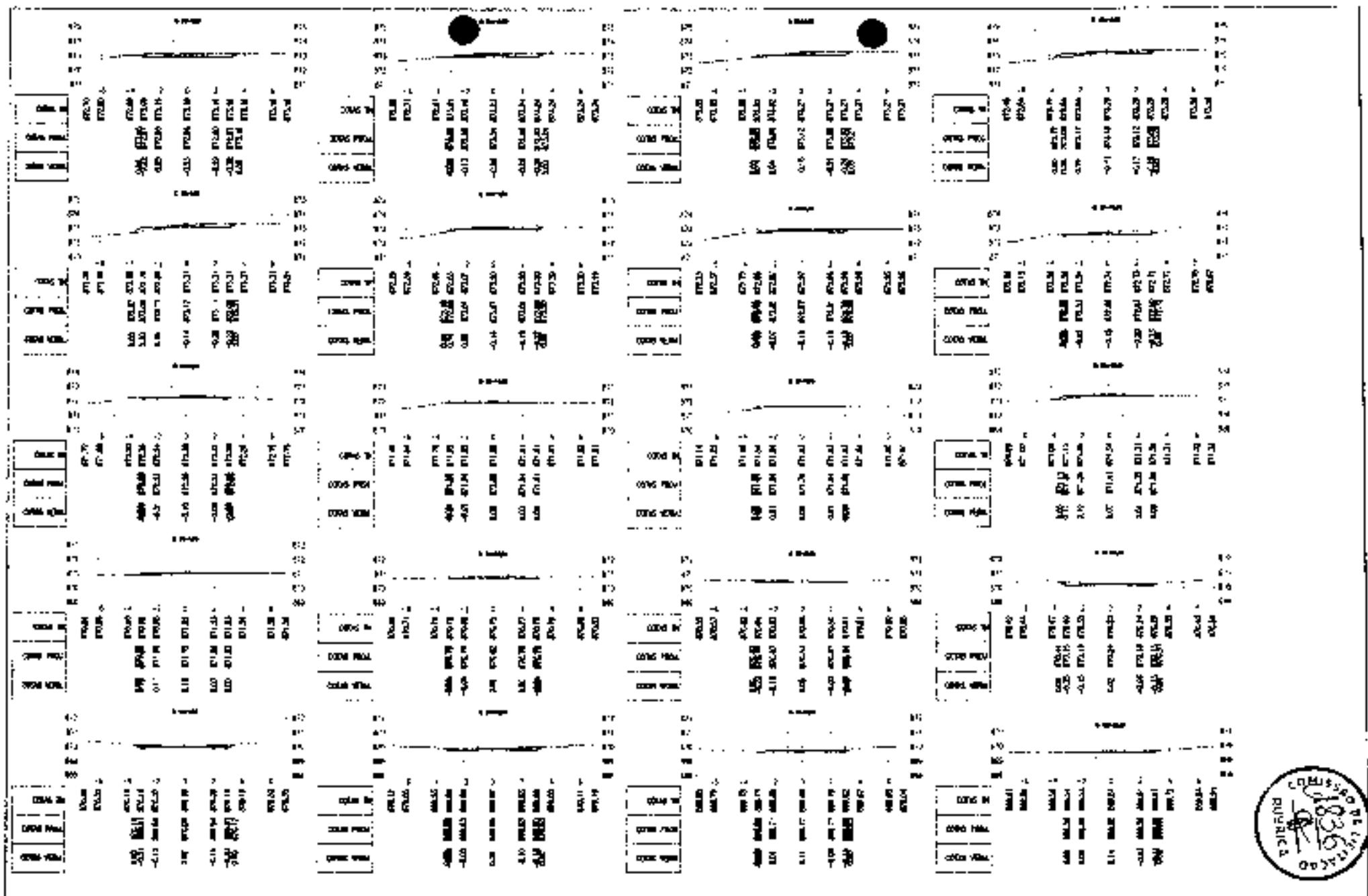

LEGENDA:

ATERRO

CORTE



PREFEITURA MUNICIPAL DE GUARACIÃ DO NORTE

RÉCUPERAÇÃO DE ESTRADAS VICINAIS NO MUNICÍPIO DE GUARACIÃ DO NORTE - CE - PI 10062/0-03

SEÇÕES TRANSVERSAIS

PROJETO DE ARQUITETURA E LAYOUT

PROJETO DE ARQUITETURA E LAYOUT

10 / 20

1/250



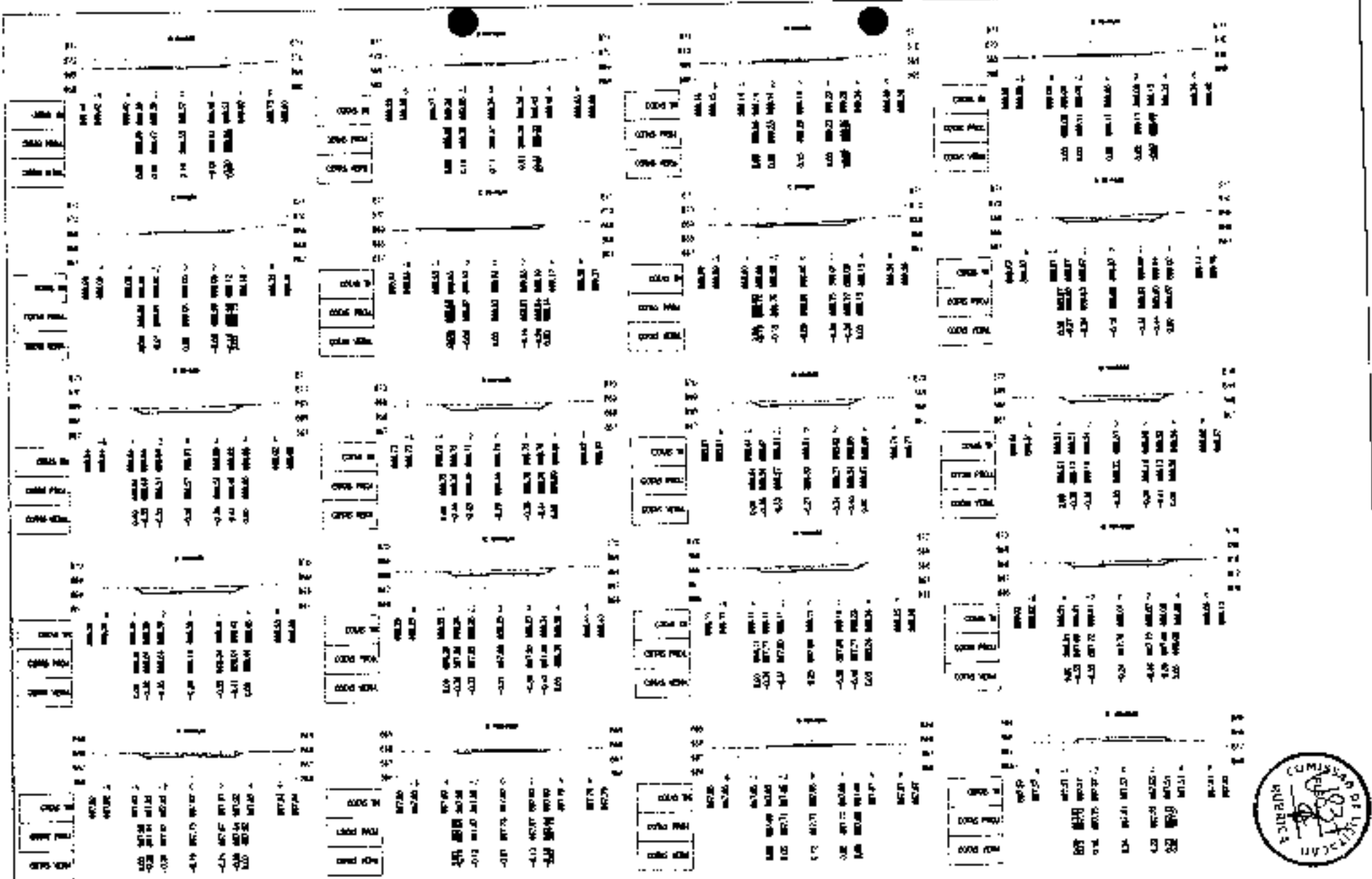

LEGENDA



AERRO

CORTE



PREFEITURA MUNICIPAL DE GUARACIÃ DO NORTE		11 / 20
RECUPERAÇÃO DE ESTRADAS VICINAIS NO MUNICÍPIO DE GUARACIÃ DO NORTE - CE - PT 1002/10-03		1:250
SEÇÕES TRANSVERSAIS		
PROJETO	OTÁVIO AUGUSTO DE MOURA FERREIRA	
PROJETO	ARQUIVADO EM 10/08/2010	

LEGENDA

-  ATERRÇO
-  CORFE

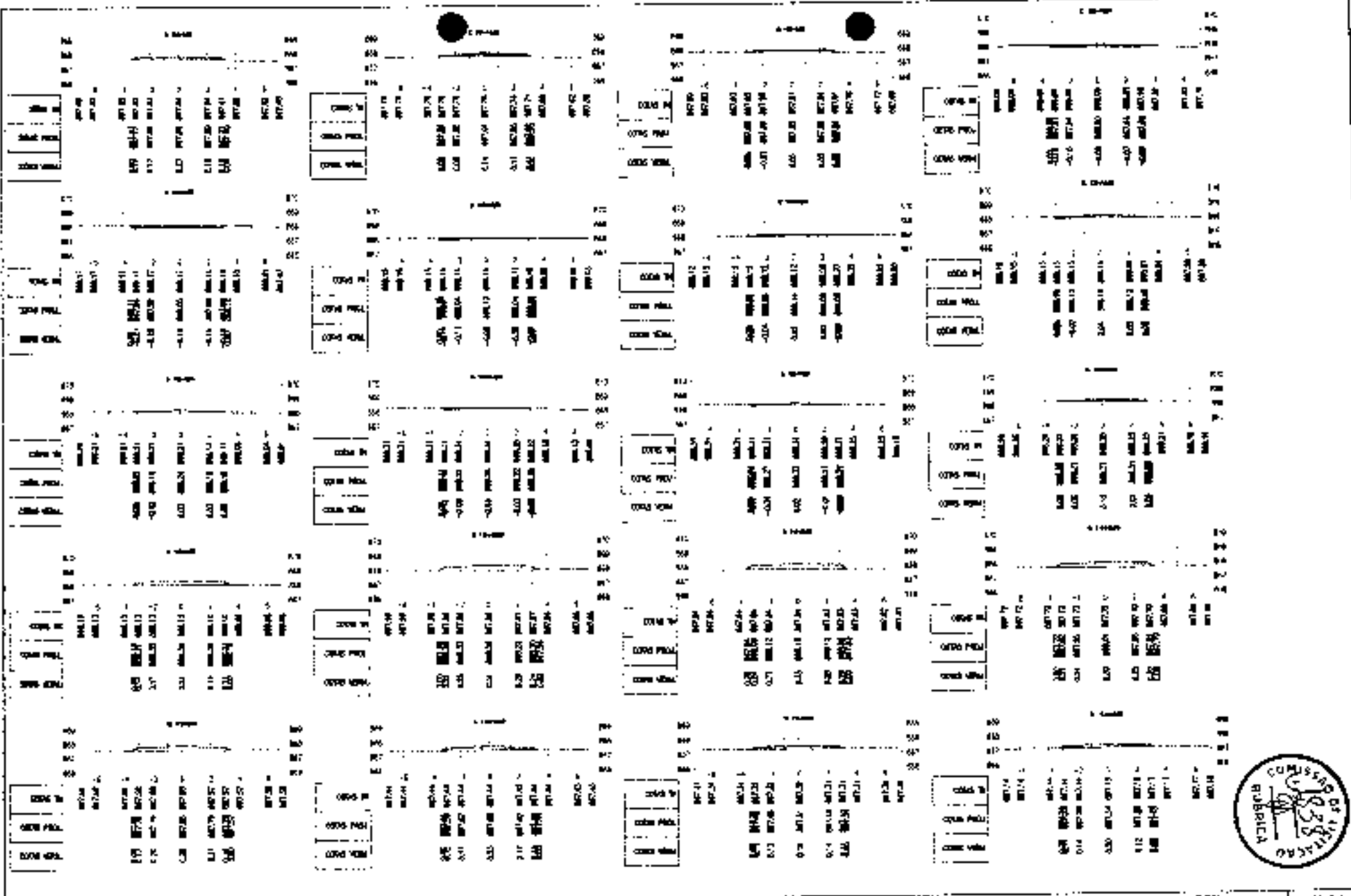



JOTA BARROS
PROJETOS

PREFEITURA MUNICIPAL DE GUARACIABA DO NORTE

RECUPERAÇÃO DE ESTRADAS VICINAIS NO MUNICÍPIO DE GUARACIABA DO NORTE-CE - PT 1085273-00

SEÇÕES TRANSVERSAIS

12/20

1:250



LEGENDA

- ATUADO
- CORTE

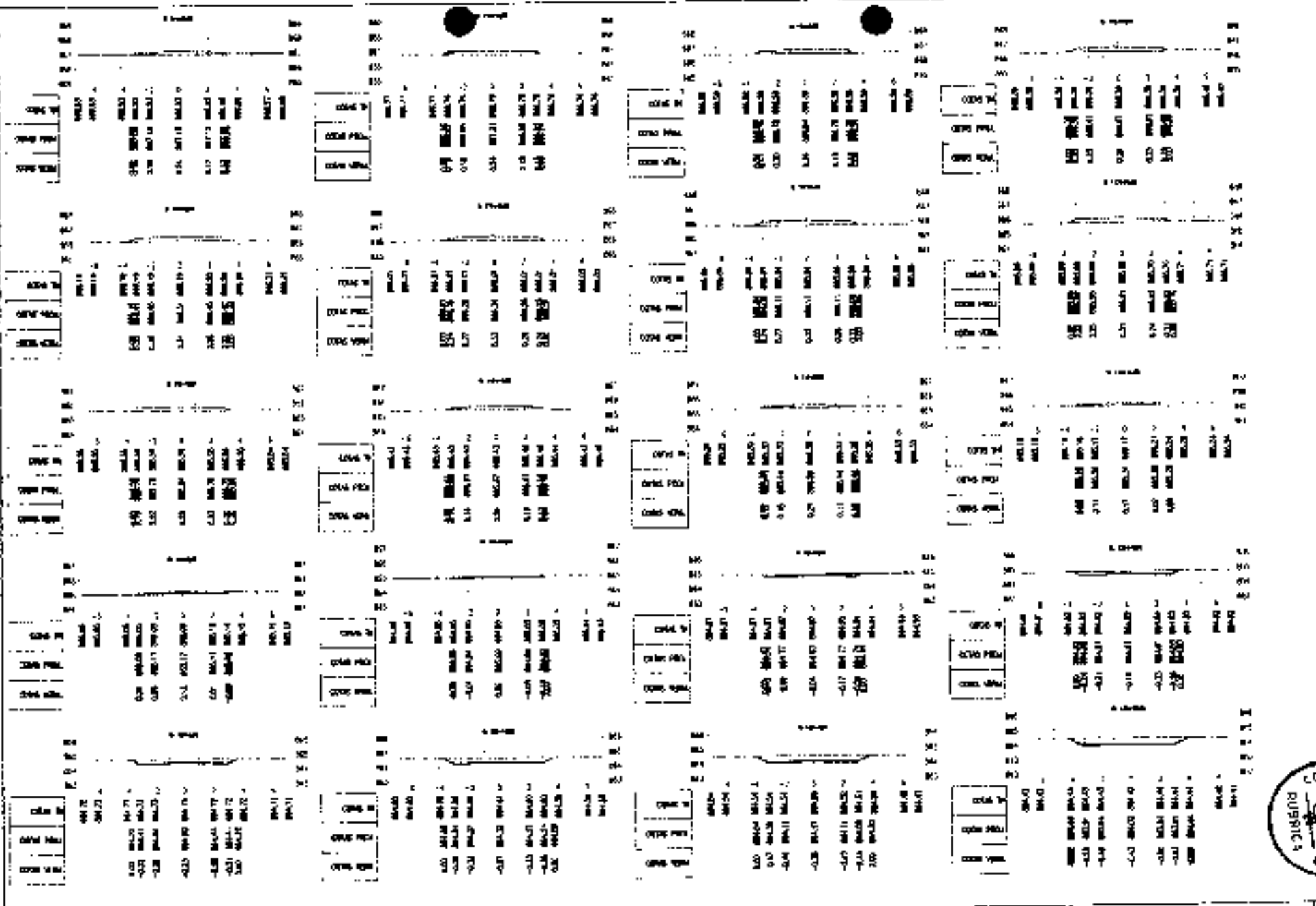



<p>JOTA SÁBIDO PROJETO</p>	<p>PREFEITURA MUNICIPAL DE QUARACAMBA DO NORTE</p> <p>RECUPERAÇÃO DE ESTRAÇAS VICINAIS NO MUNICÍPIO DE GUARACIARA DO NORTE/CE - PT 10R62TU-01</p> <p>SEÇÕES TRANSVERSAIS</p>		<p>AVULSO</p> <p>13 / 20</p> <p>1/250</p>
	PROJETO	ELABORADO POR	DATA DE ELABORAÇÃO
	FECHA	PROJETO Nº	PROJETO Nº

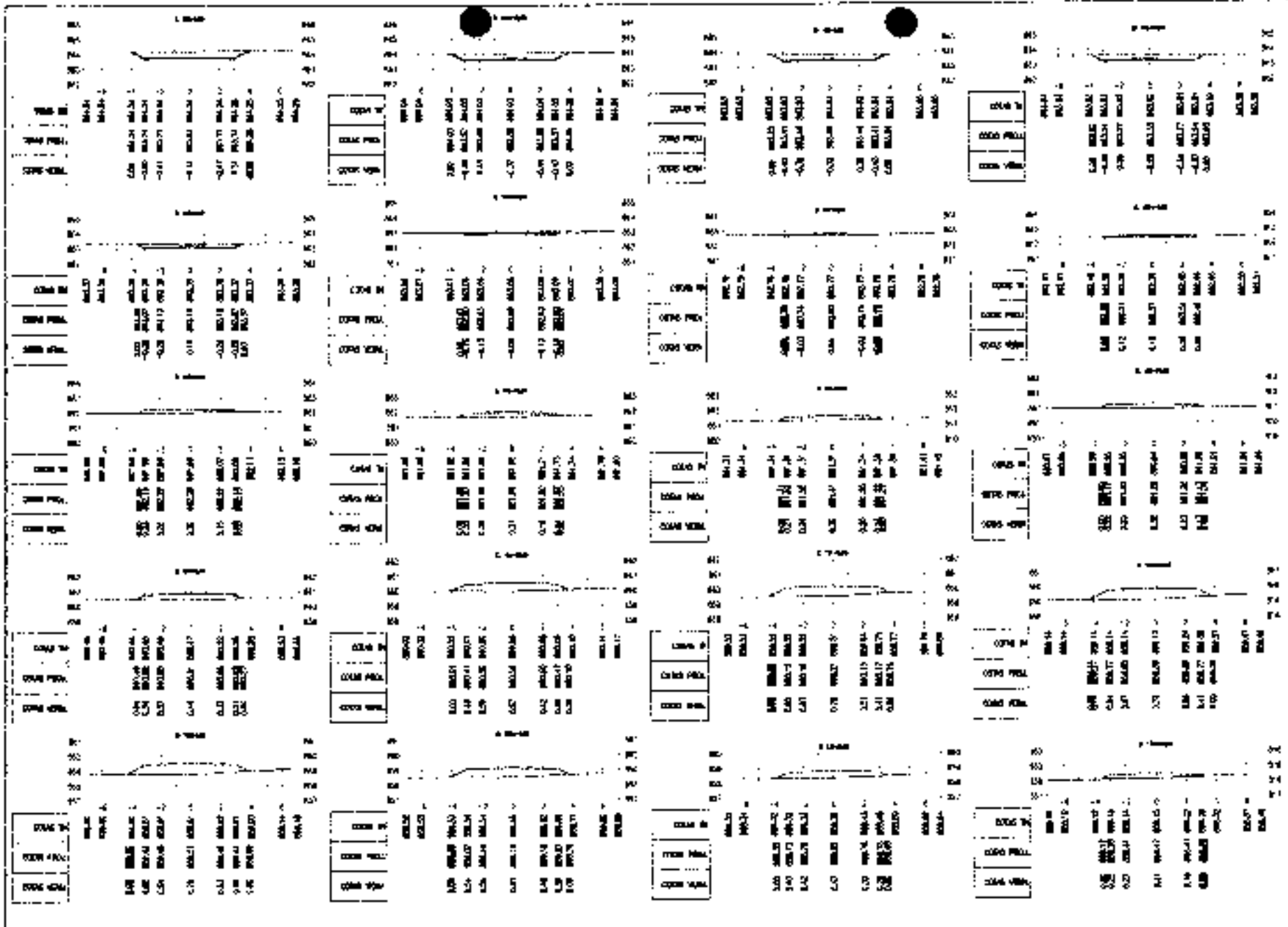



LEGENDA:

 ATERRO

 CURTE



PREFEITURA MUNICIPAL DE GUARADABA DO NORTE

RECOMENDAÇÃO DE ESTRADAS VICINAIS NO MUNICÍPIO DE GUARADABA DO NORTE-CE - PT 1 (RE270-03)

SEÇÕES TRANSVERSAIS

PROJETO: COTA BARRIOS PARTICIPATÓRIOS

DATA: 15/05/2014

14 / 20

1:750



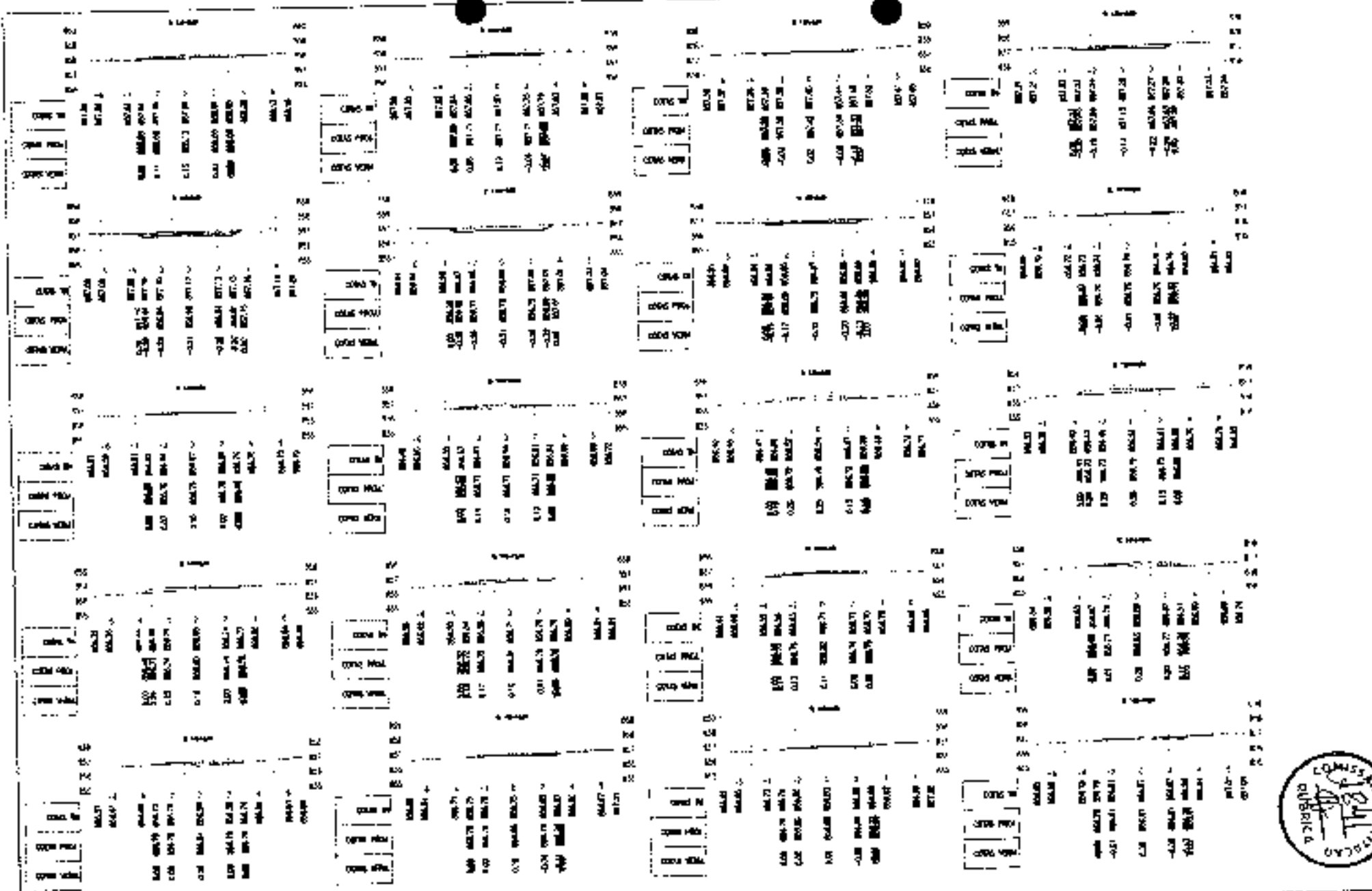

ALBERGO
CORTA



PREFEITURA MUNICIPAL DE GUARACIABA DO NORTE
RECONSTRUÇÃO DE ESTADUAS VICINAIS NO MUNICÍPIO DE GUARACIABA DO NORTE-CE - PT. 1/26627003
SEÇÕES TRANSVERSAIS

15/20
10/50



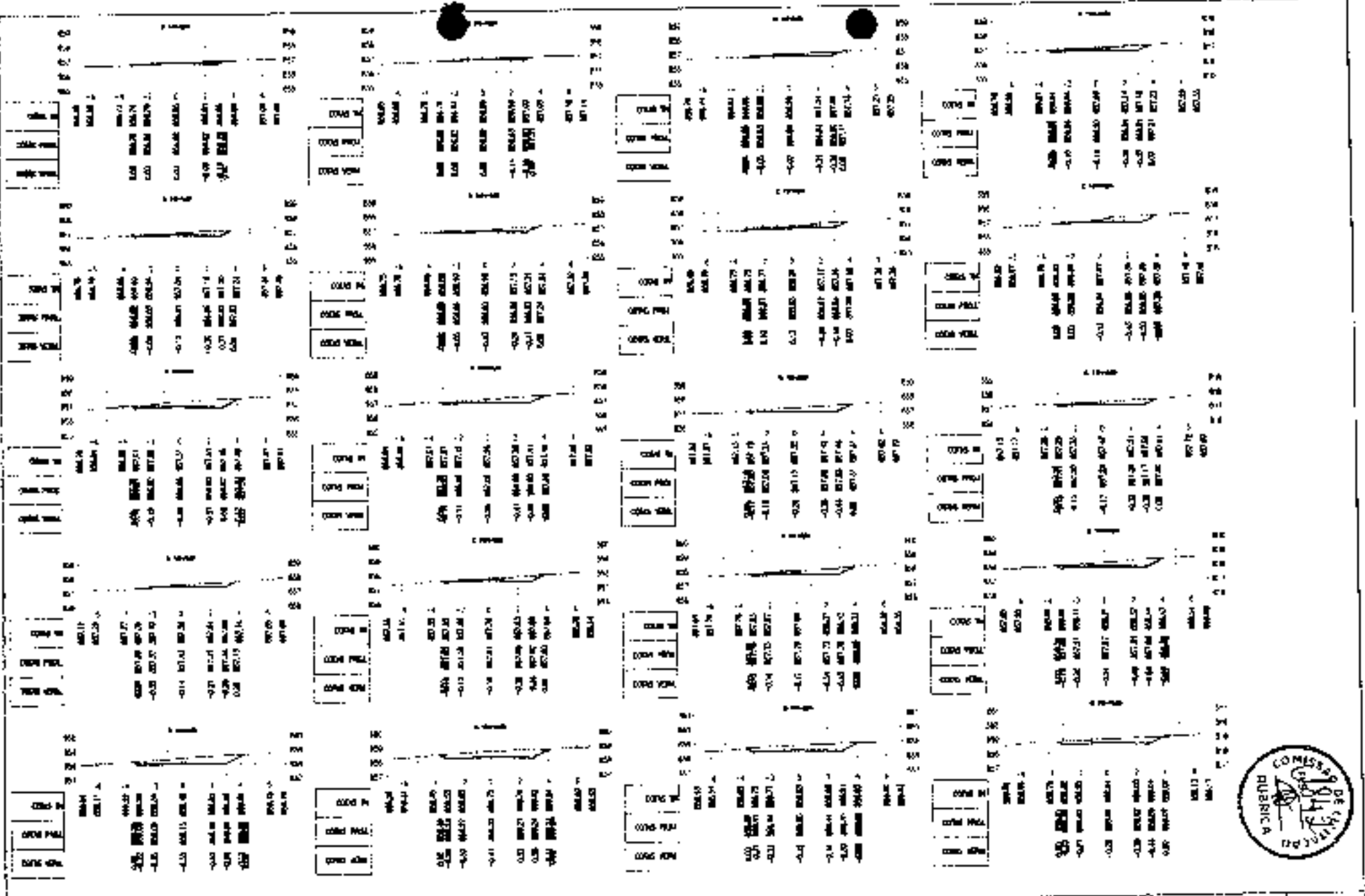

LEGENDA:

ATERRO

CORTE



PREFEITURA MUNICIPAL DE GUARACIABA DO NORTE

RECUPERAÇÃO DE ESTRADAS VICINAIS NO MUNICÍPIO DE GUARACIABA DO NORTE-CE - PT 108270-03

SEÇÕES TRANSVERSAIS

PROJETO DE: JOTA BARRIOS PROJETOS

DATA: 10/05/2011

16 / 20

1:250



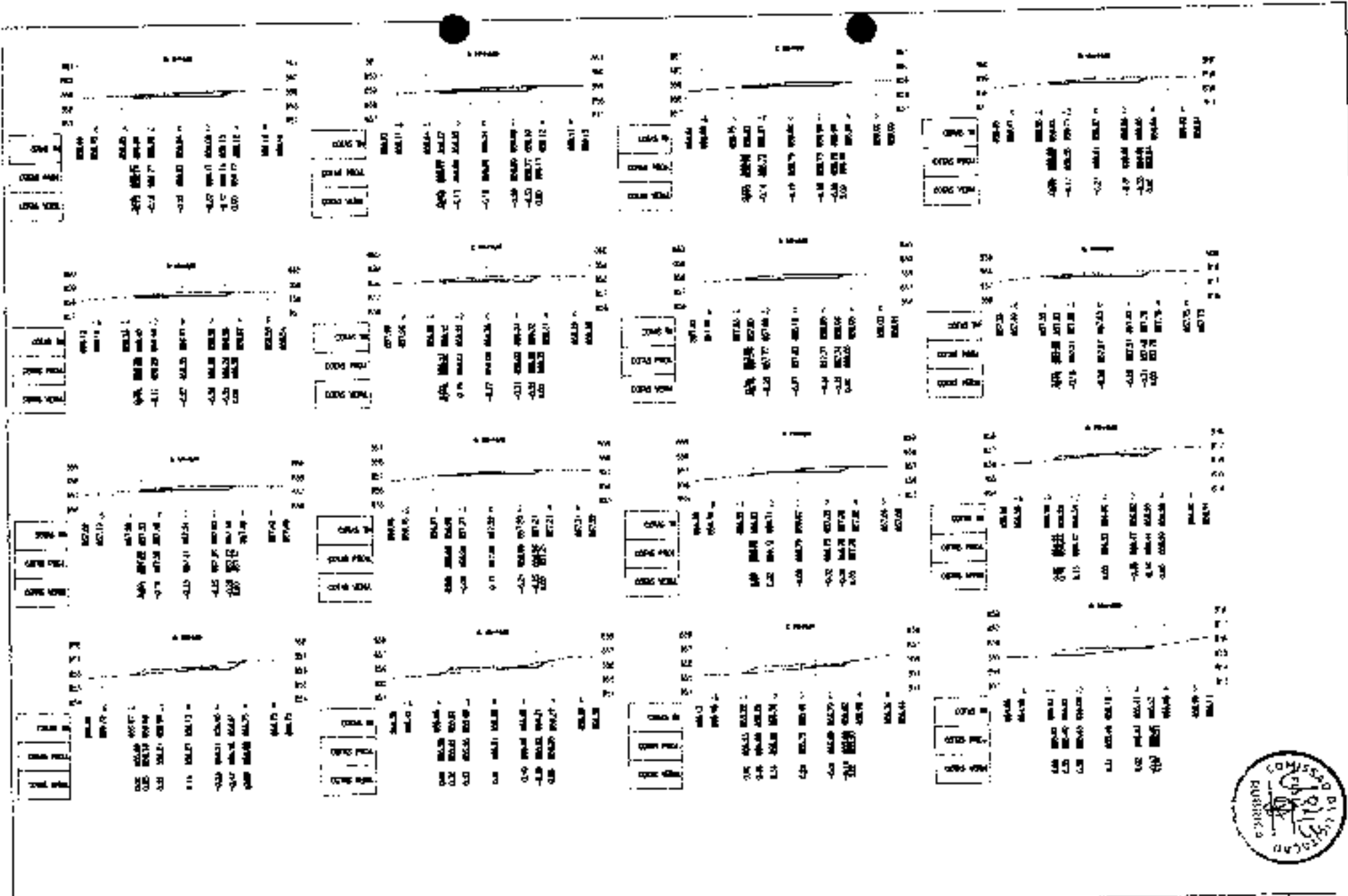

LEGENDA:

- ATERRO
- CORTE



PREFEITURA MUNICIPAL DE GUARACIABA DO NORTE
 RECUPERAÇÃO DE ESTRADAS VICINAIS NO MUNICÍPIO DE GUARACIABA DO NORTE-CE - P.º 1046270-03
 SEÇÕES TRANSVERSAIS

17 / 20
 1/250



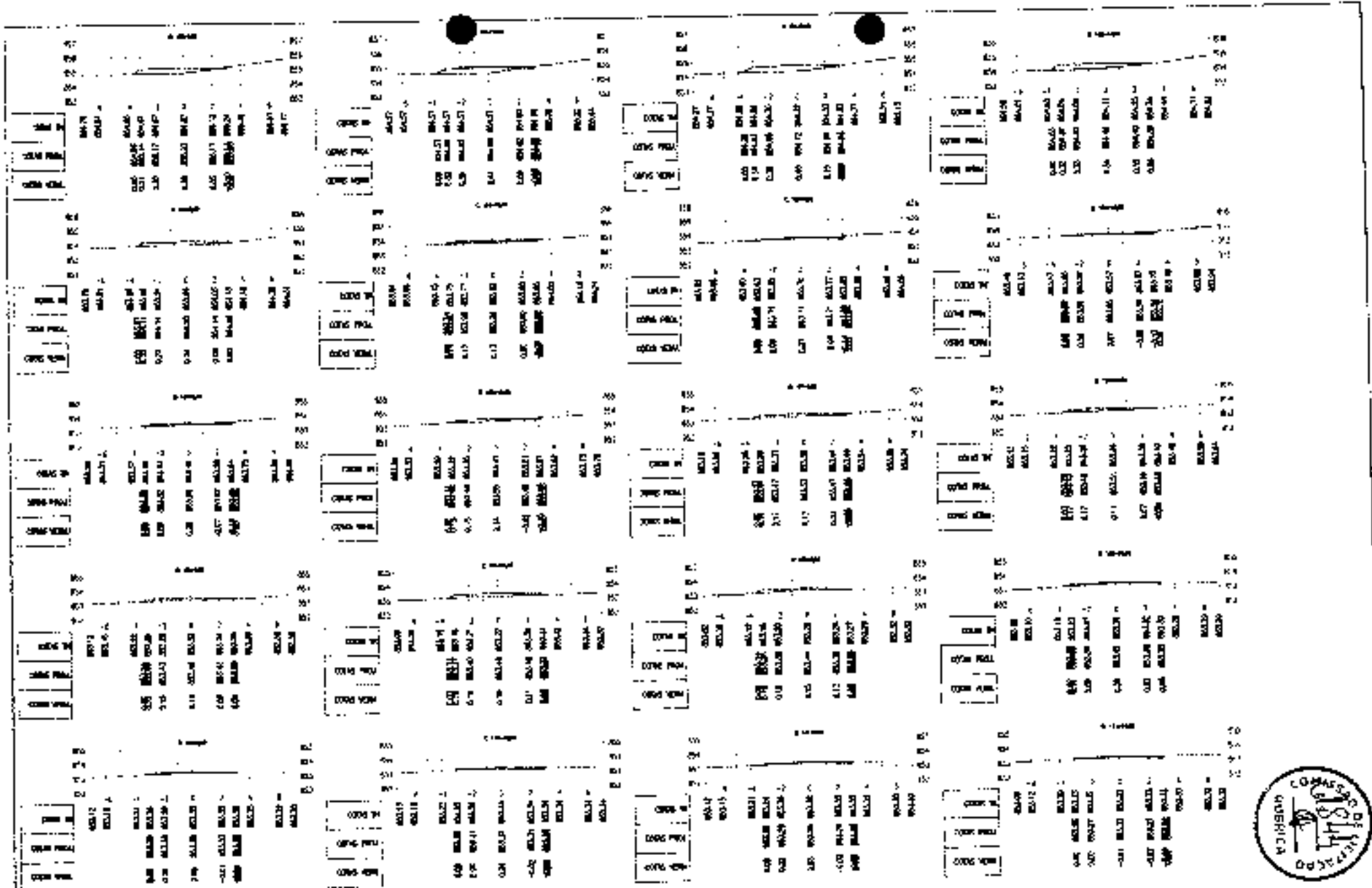

(FGFMDA)

ATERRO

CORTIÇ



PREFEITURA MUNICIPAL DE GUARACIARA DO NORTE

RECUPERAÇÃO DE ESTRADAS VICINAIS NO MUNICÍPIO DE GUARACIARA DO NORTE-CE - PT 10882/0-03

SEÇÕES TRANSVERSAIS

PROJ. DE ARQUITETURA: [illegible]

PROJ. DE ENGENHARIA: [illegible]

18 / 20

1:250



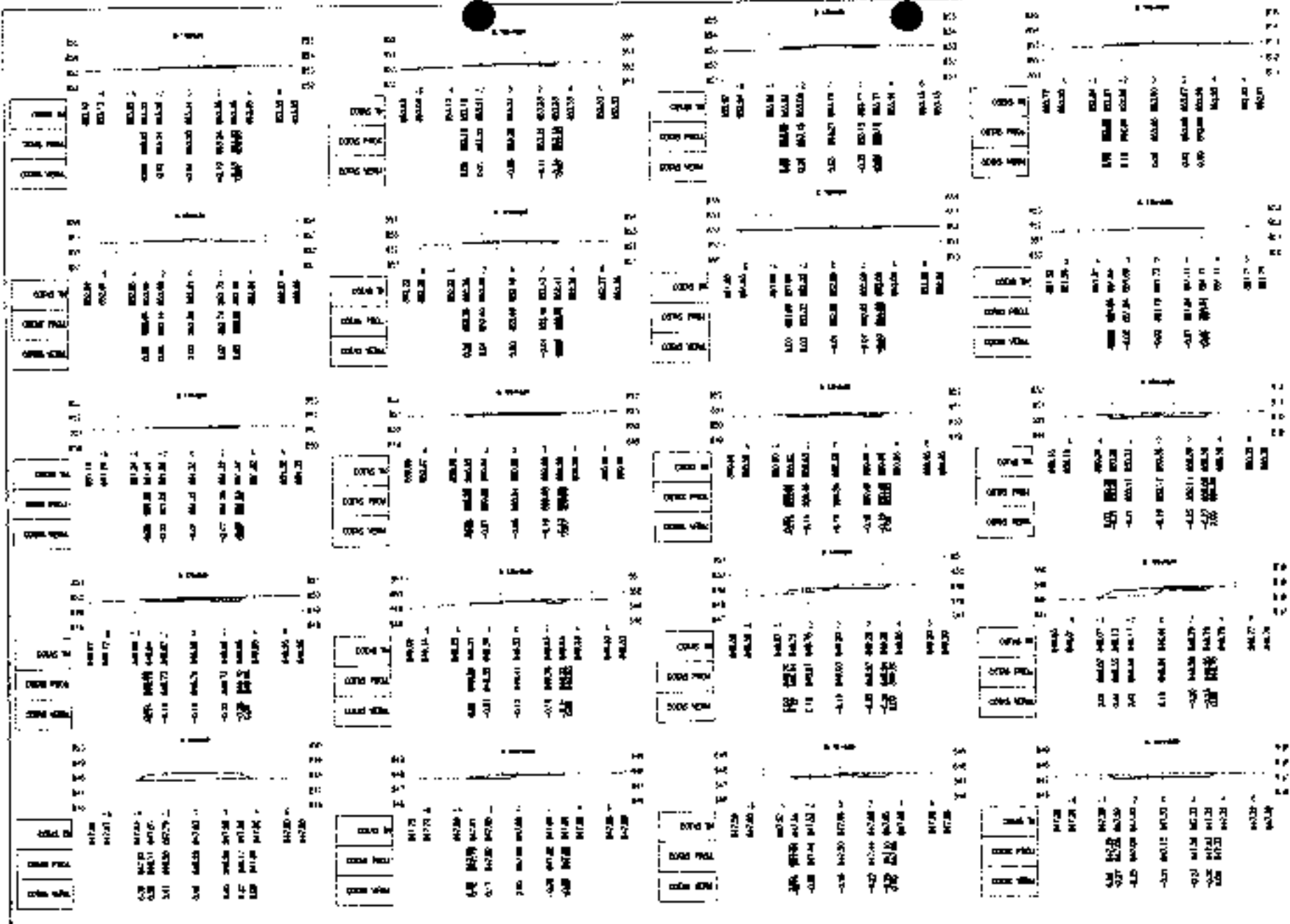

LEGENDA:

- ATERRO
- CORTE





PREFEITURA MUNICIPAL DE GUARACIABA DO NORTE
 RECUPERAÇÃO DE ESTRADAS VIZINIAS AO MUNICÍPIO DE GUARACIABA
 DO NORTE CE - PT 1486270-03
 SEÇÕES TRANSVERSAIS

PARCELA	19 / 20
ESCALA	1:250

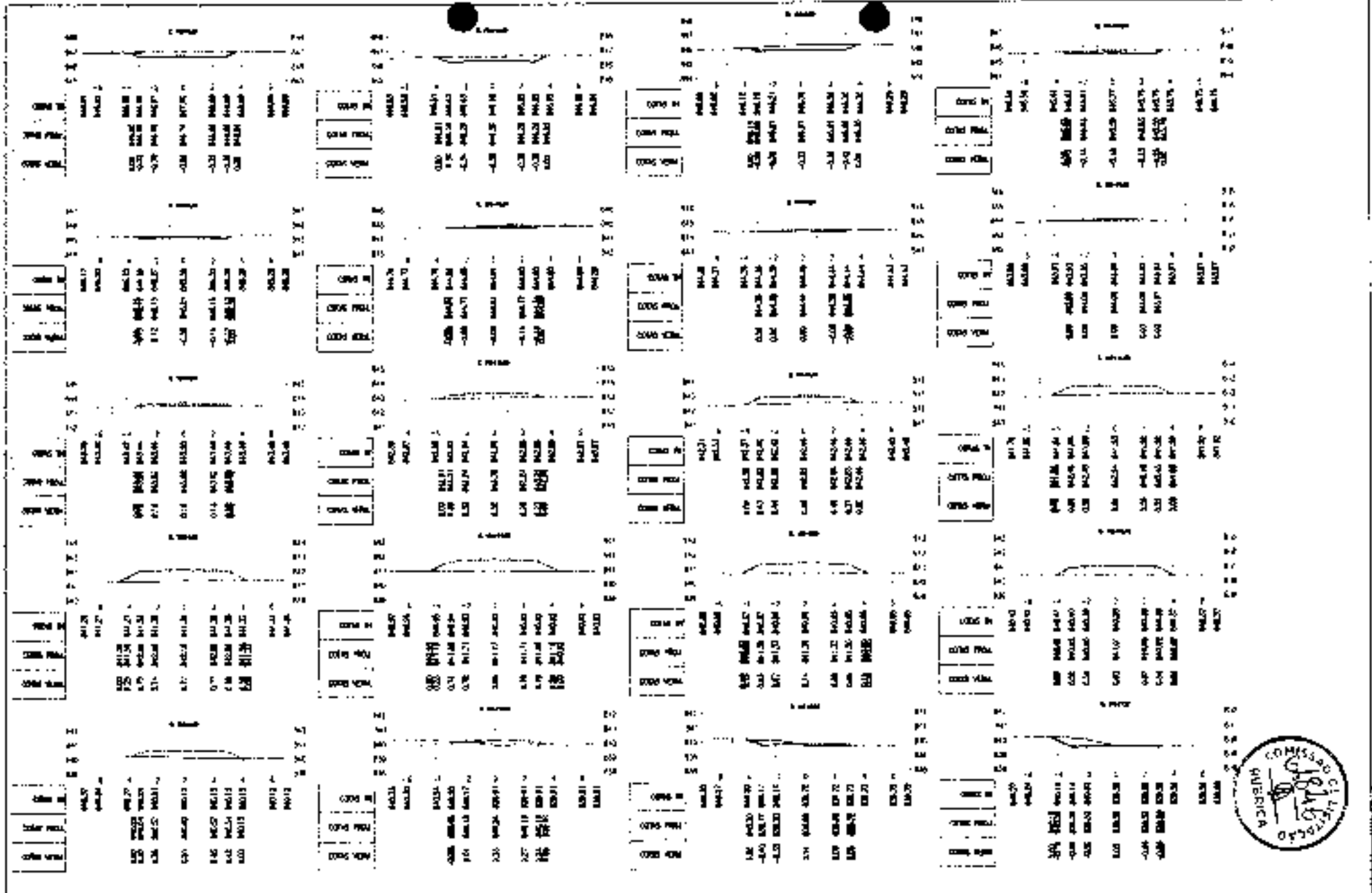



LEGENDA:

-  ATERRO
-  CORTE

	PREFEITURA MUNICIPAL DE GUARACIÁ DO NORTE RECUPERAÇÃO DE ESTRADAS VICINAIS NO MUNICÍPIO DE GUARACIÁ DO NORTE-CE - PT 1062270-03 SEÇÕES TRANSVERSAS		Nº 20/20 DATA: 20/20
	PROJETO DE RECUPERAÇÃO DE ESTRADAS VICINAIS		FOLHA: 10250
	ESCALA: 1:1000		



0 1000 2000

0 1000 2000

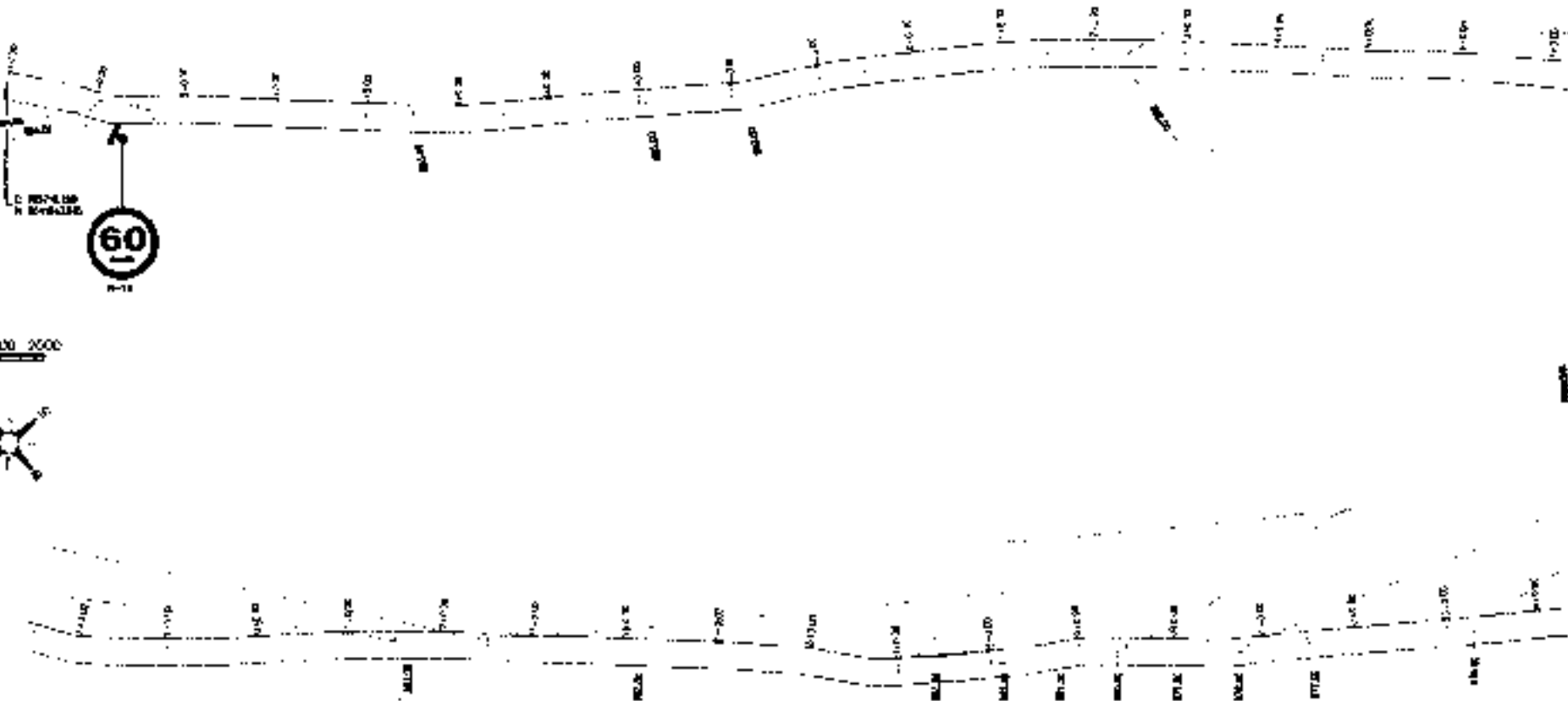

	PREFEITURA MUNICIPAL DE GUARACIABA DO NORTE		DATA:
	RECUPERAÇÃO DE ESTRADAS VICINAIS NO MUNICÍPIO DE GUARACIABA DO NORTE-CE - PT 168270-03		ESCALA: 1/07
	SINALIZAÇÃO VIÁRIA		DATA: 1/1000
PROJETO:	EXECUÇÃO:		APROVAÇÃO:

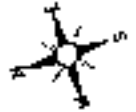

0 1000 2000

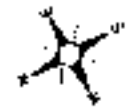

0 1000 2000

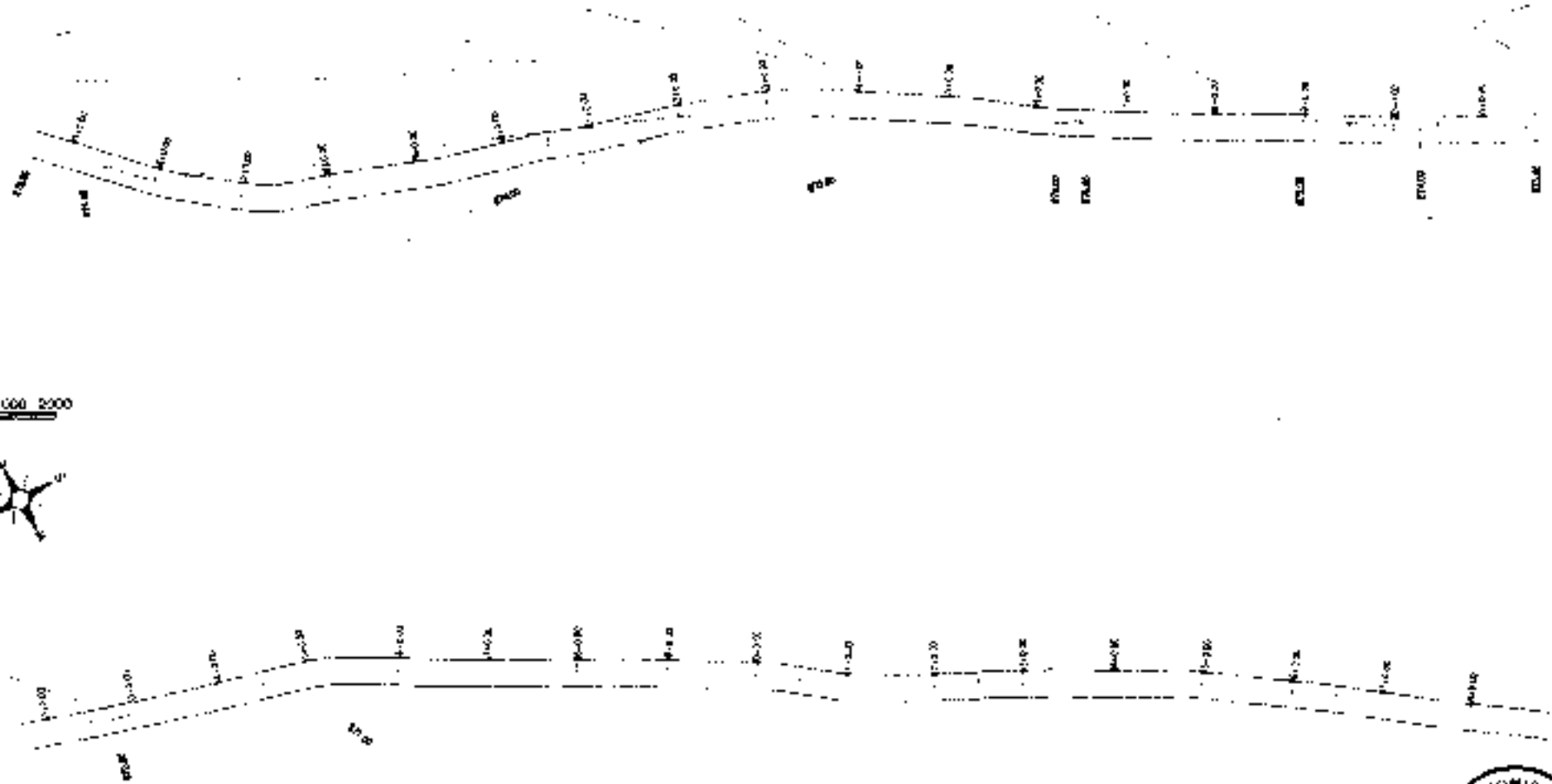

PREFEITURA MUNICIPAL DE GUARAJABA DO NORTE	
RECUPERAÇÃO DE ESTRADAS VICINAIS NO MUNICÍPIO DE GUARAJABA DO NORTE-CE - PT 188278-00	
SINALIZAÇÃO VIÁRIA	
PROJETO	PROJETO DE SINALIZAÇÃO VIÁRIA
ARQUITETO	JOTA LANCHES PROJETOS

PARTE	2 / 07
ESCALA	1:1000

plano - 1



0 1000 2000

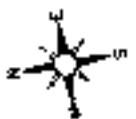

0 1000 2000

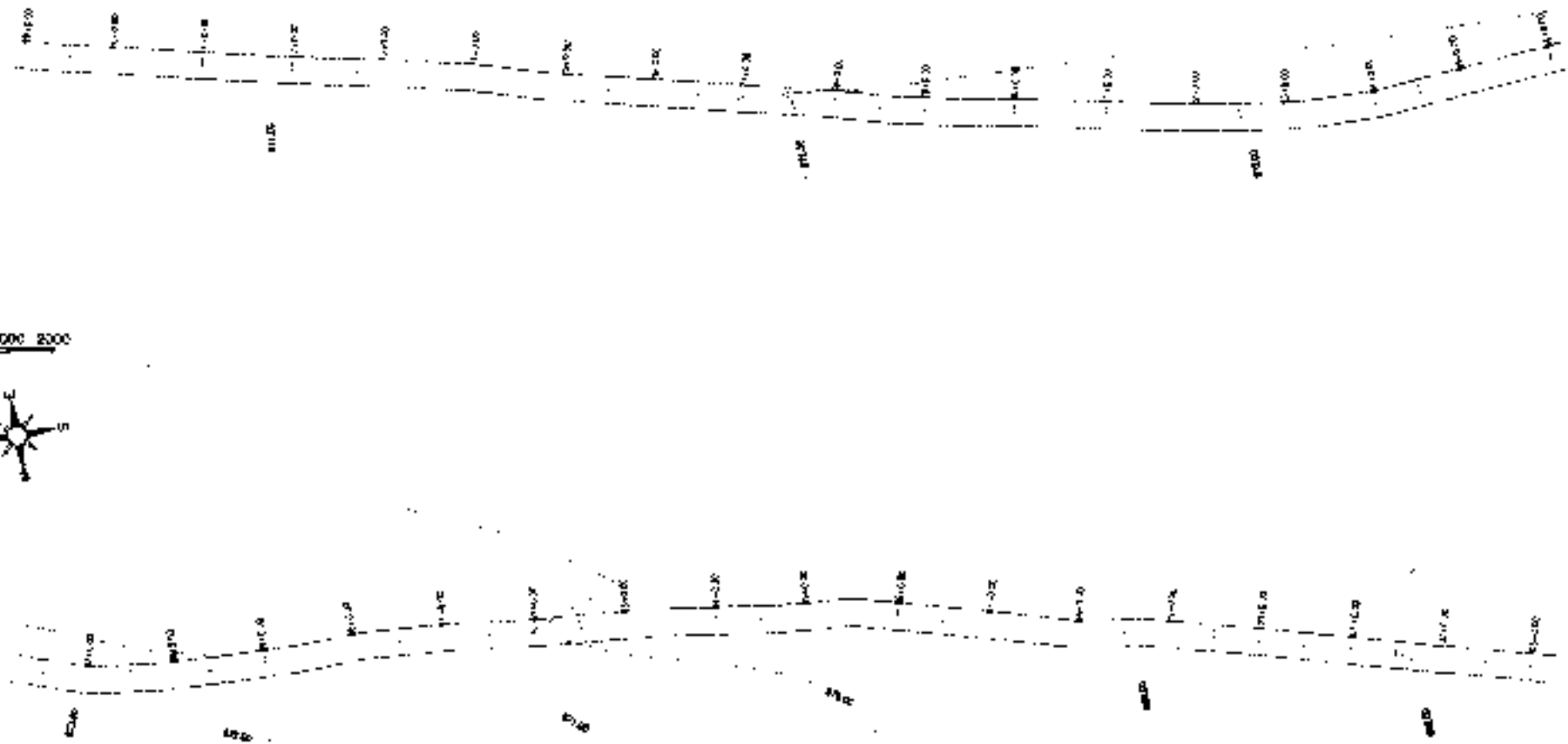

PLANIM - 1



PREFEITURA MUNICIPAL DE GUARACIABA DO NORTE
 RECUPERAÇÃO DE ESTRADAS VICINAIS NO MUNICÍPIO DE GUARACIABA DO NORTE-CE - PT 1086270-03
 SINALIZAÇÃO VIÁRIA

3 / 07
 ESCALA
 1:1000

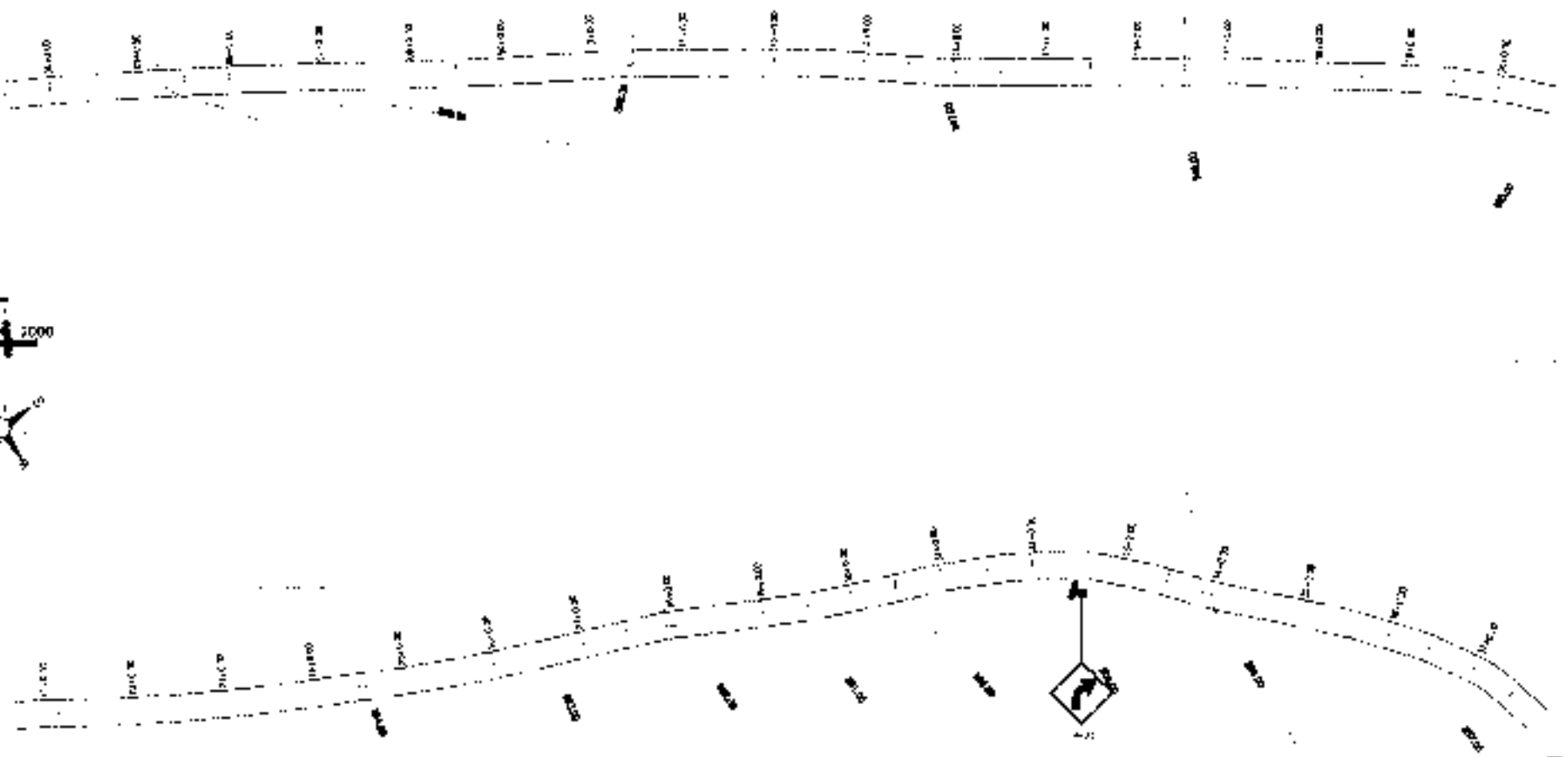
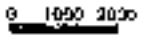

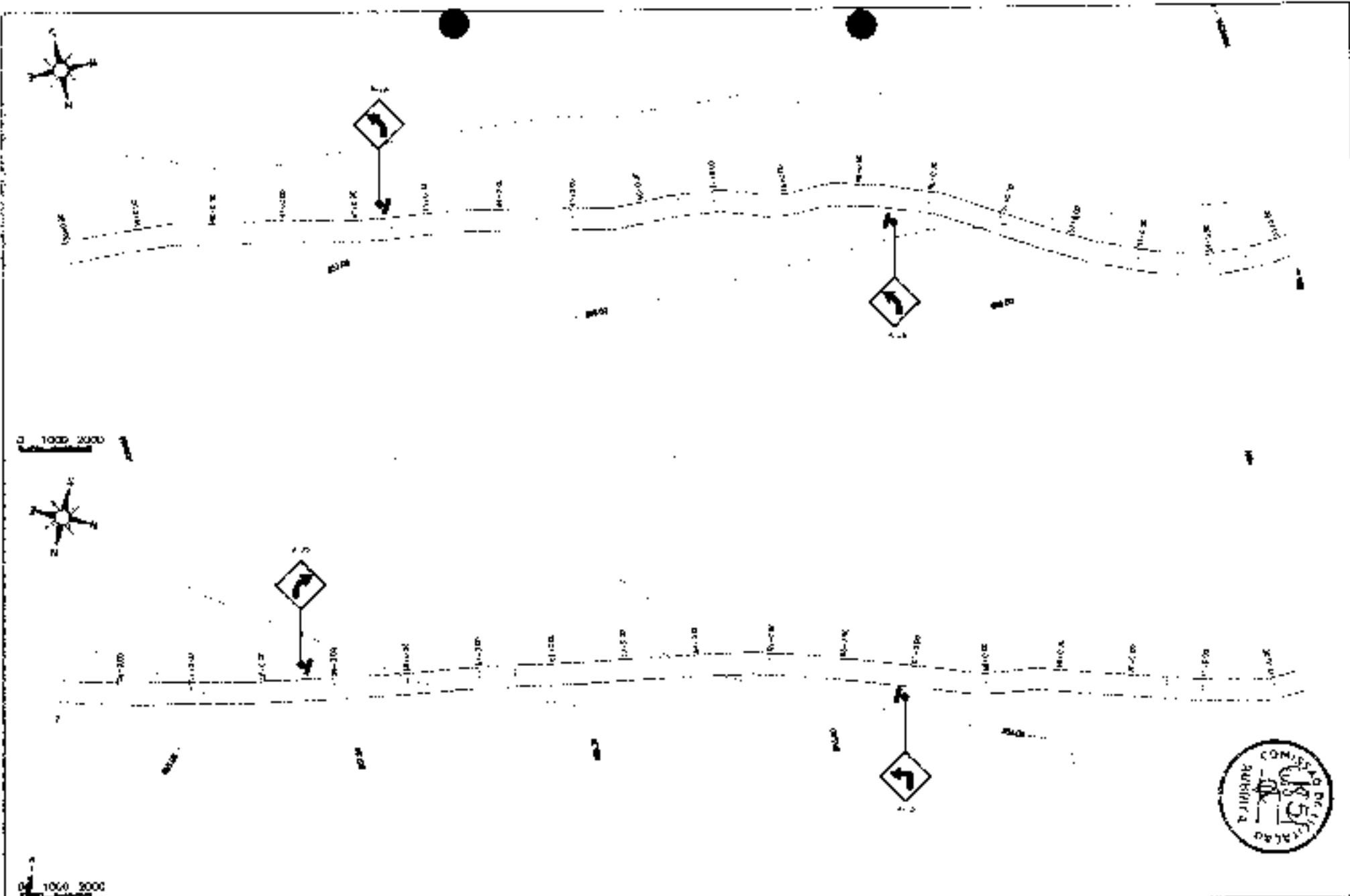

PREFEITURA MUNICIPAL DE GUARACIABA DO NORTE
 RECUPERAÇÃO DE ESTRADAS VICINAIS NO MUNICÍPIO DE GUARACIABA DO NORTE - CE - PT 1086270-03
 SINALIZAÇÃO VIÁRIA

4 / 07
 1-1000

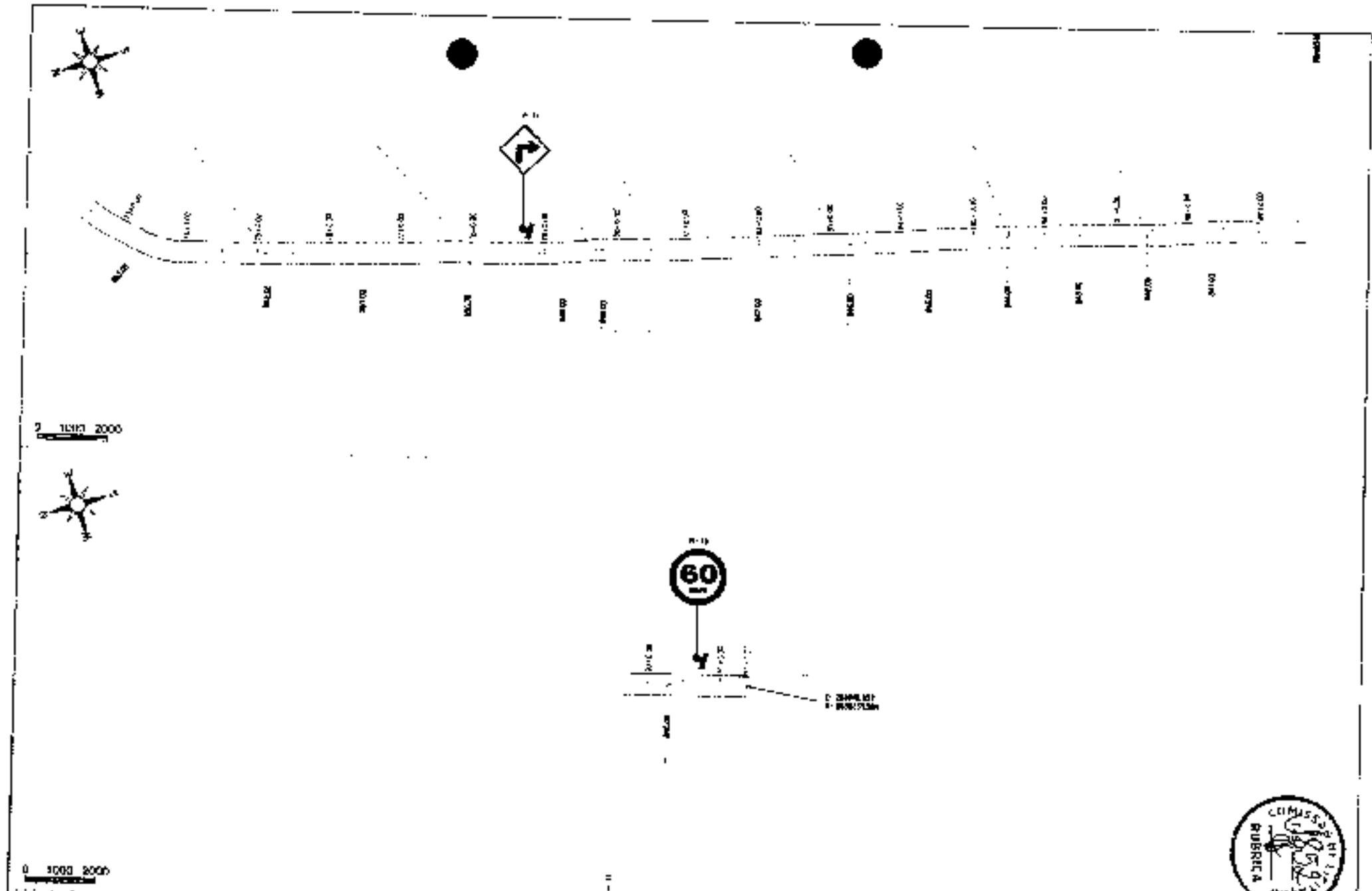

PREFEITURA MUNICIPAL DE GUARACIABA DO NORTE		PROJETO
RECUPERAÇÃO DE ESTRADAS VICINAIS NO MUNICÍPIO DE GUARACIABA DO NORTE - CC - PT 1086270-03		5 / 07
SINALIZAÇÃO VIÁRIA		ESCALA
DATA DE ELABORAÇÃO	20/03/2014	1:1000
ELABORADO POR	JOTA CARREIRAS PROJETOS	



	PREFEITURA MUNICIPAL DE GUARACIABA DO NORTE RECUPERAÇÃO DE ESTRADAS VICINAIS NO MUNICÍPIO DE GUARACIABA DO NORTE - CE - PE 1086270-03		DATA 6 / 07
	SINALIZAÇÃO VIÁRIA		ESCALA 1 / 1000
PROJETO	EXECUÇÃO		OBSERVAÇÕES

Posicionamento transversal

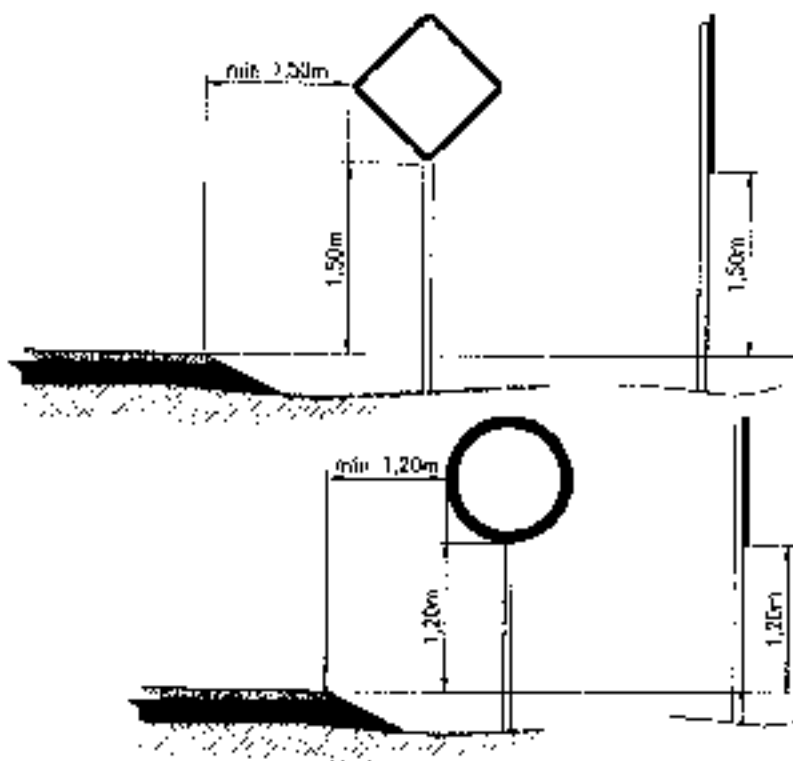

PLACAS DE ADVERTÊNCIA

PLACAS	CÓDIGO NBR 10627-2003	
	Def	Unq
	1	1
	2	1
	3	1
	4	1

PLACAS DE ADVERTÊNCIA

PLACAS	CÓDIGO NBR 10627-2003	
	Def	Unq
	1	1

As Placas de Advertência ser as seguintes dimensões:

- | | | | |
|--------------|---------|--------------|-------------|
| Letra | = 0,8cm | Forma | = Triângulo |
| Área externa | = 0,01m | Órg. interna | = Branca |
| Área interna | = 0,02m | Órg. externa | = Amarelo |
| | | Contorno | = Preto |
| | | Margem | = Preto |



	PREFEITURA MUNICIPAL DE GUARACIABA DO NORTE		DATA 7 / 07 SEM ESC
	RECUPERAÇÃO DE ESTRADAS VICINAIS NO MUNICÍPIO DE GUARACIABA DO NORTE - CE - PT 106627003		
	SINALIZAÇÃO VIÁRIA		
PROJ. DE EN.	LUCAS DE ALMEIDA NEVES JUNIOR - RUA SERRA DO		
REVISÃO	LUCAS DE ALMEIDA NEVES JUNIOR		

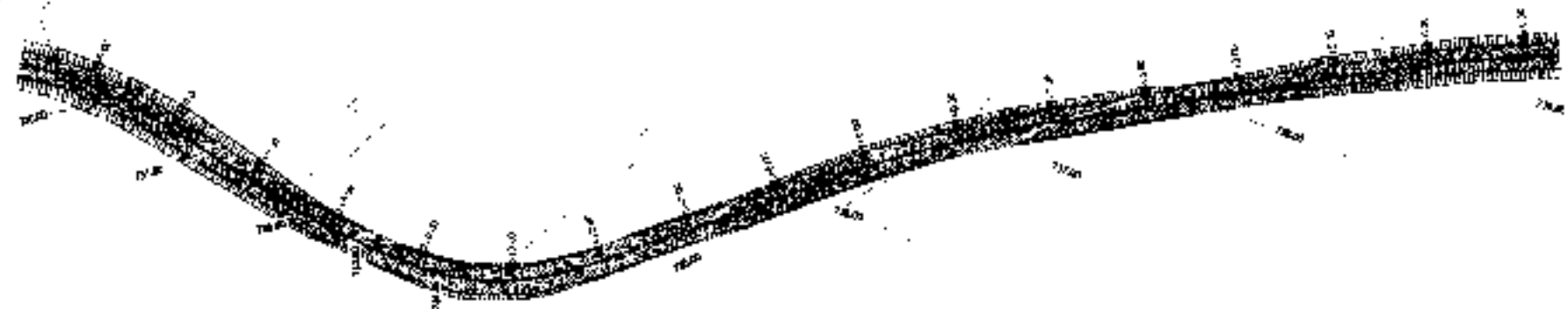

1:2000

0 1000 2000

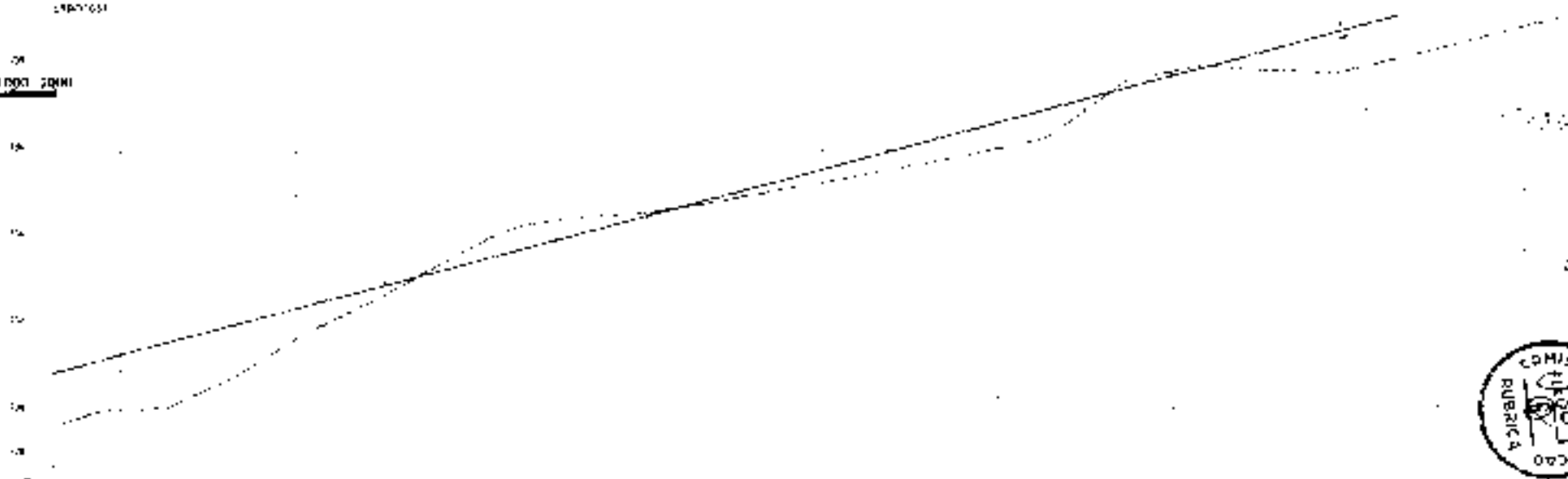

0+00	0+10	0+20	0+30	0+40	0+50	0+60	0+70	0+80	0+90	1+00	1+10	1+20	1+30	1+40	1+50	1+60	1+70	1+80	1+90	2+00
12.5	13.0	13.5	14.0	14.5	15.0	15.5	16.0	16.5	17.0	17.5	18.0	18.5	19.0	19.5	20.0	20.5	21.0	21.5	22.0	22.5



PREFEITURA MUNICIPAL DE GUARACIABA DO NORTE
 RECUPERAÇÃO DE ESTRADAS VICINAIS NO MUNICÍPIO DE GUARACIABA
 DO NORTE - CE - PT 1086270-01
ESTAQUEAMENTO E PERFIL LONGITUDINAL
 Nº 11-1000
 V 1-100



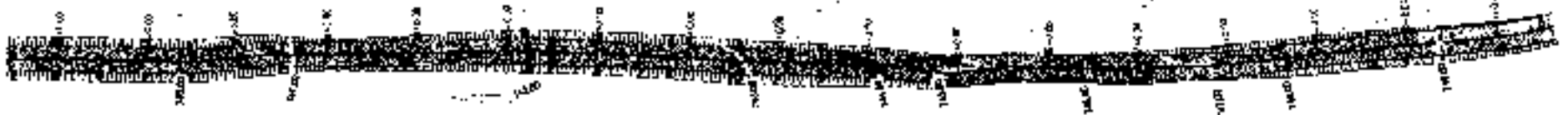

0 1000 2000

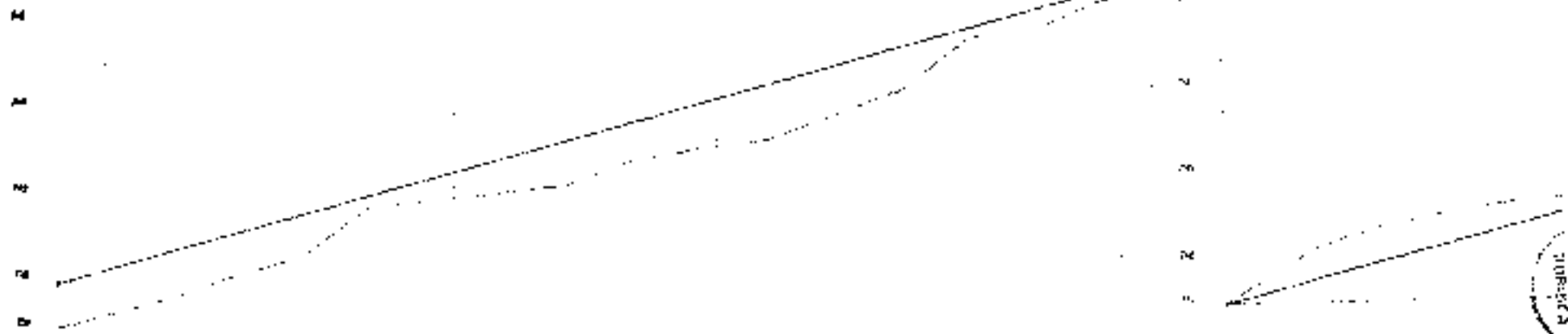

1	2	3	4	5	6	7	8	9	10	11	12	13	14	15	16	17	18	19	20	21	22	23	24	25	26	27	28	29	30	31	32	33	34	35	36	37	38	39	40	41	42	43	44	45	46	47	48	49	50	51	52	53	54	55	56	57	58	59	60	61	62	63	64	65	66	67	68	69	70	71	72	73	74	75	76	77	78	79	80	81	82	83	84	85	86	87	88	89	90	91	92	93	94	95	96	97	98	99	100
---	---	---	---	---	---	---	---	---	----	----	----	----	----	----	----	----	----	----	----	----	----	----	----	----	----	----	----	----	----	----	----	----	----	----	----	----	----	----	----	----	----	----	----	----	----	----	----	----	----	----	----	----	----	----	----	----	----	----	----	----	----	----	----	----	----	----	----	----	----	----	----	----	----	----	----	----	----	----	----	----	----	----	----	----	----	----	----	----	----	----	----	----	----	----	----	----	----	----	-----

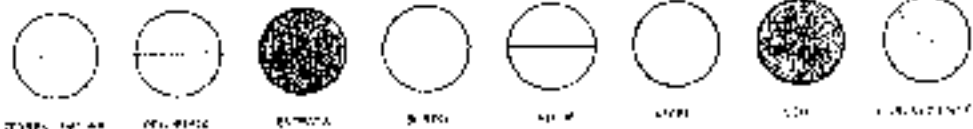

PREFEITURA MUNICIPAL DE GUARACIABA DO NORTE
 RECUPERAÇÃO DE ESTRADAS VICINAIS NO MUNICÍPIO DE GUARACIABA DO NORTE-CE - PT 1086270-03
 ESTACQUEAMENTO E PERFIL LONGITUDINAL



3 / 09
 ESCALA
 H 1:1000
 V 1:100

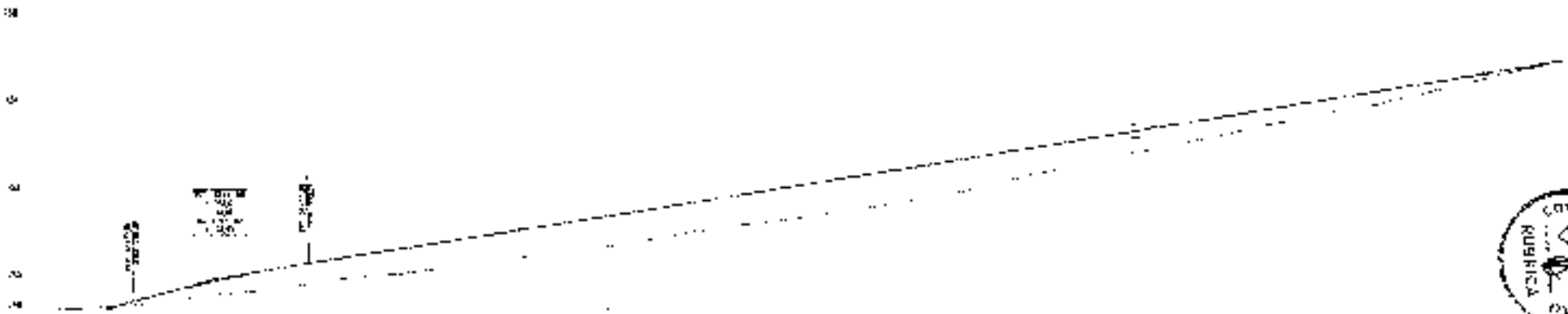
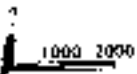
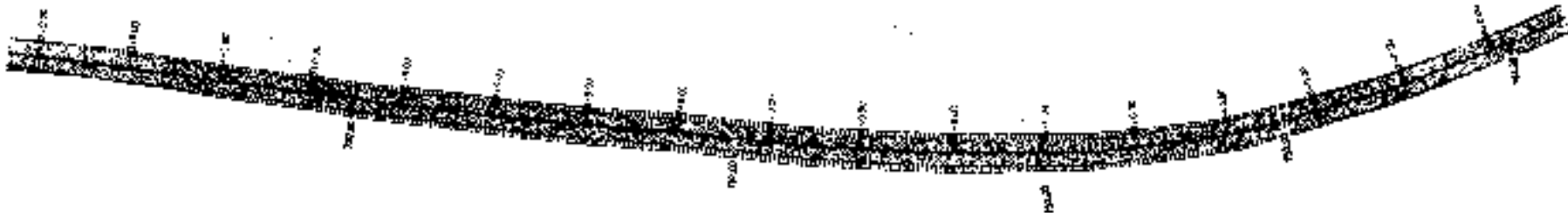

1	2	3	4	5	6	7	8	9	10	11	12	13	14	15	16	17	18	19	20	21	22	23	24	25	26	27	28	29	30	31	32	33	34	35	36	37	38	39	40	41	42	43	44	45	46	47	48	49	50	51	52	53	54	55	56	57	58	59	60	61	62	63	64	65	66	67	68	69	70	71	72	73	74	75	76	77	78	79	80	81	82	83	84	85	86	87	88	89	90	91	92	93	94	95	96	97	98	99	100
---	---	---	---	---	---	---	---	---	----	----	----	----	----	----	----	----	----	----	----	----	----	----	----	----	----	----	----	----	----	----	----	----	----	----	----	----	----	----	----	----	----	----	----	----	----	----	----	----	----	----	----	----	----	----	----	----	----	----	----	----	----	----	----	----	----	----	----	----	----	----	----	----	----	----	----	----	----	----	----	----	----	----	----	----	----	----	----	----	----	----	----	----	----	----	----	----	----	----	-----



PREFEITURA MUNICIPAL DE GUARACIABA DO NORTE
 RECUPERAÇÃO DE ESTRADAS VICINAIS NO MUNICÍPIO DE GUARACIABA DO NORTE - CE - PT 1086270-03
 ESTAQUEAMENTO E PERFIL LONGITUDINAL



4 / 09
 H 1:000
 V 1:100



0 1000 2000

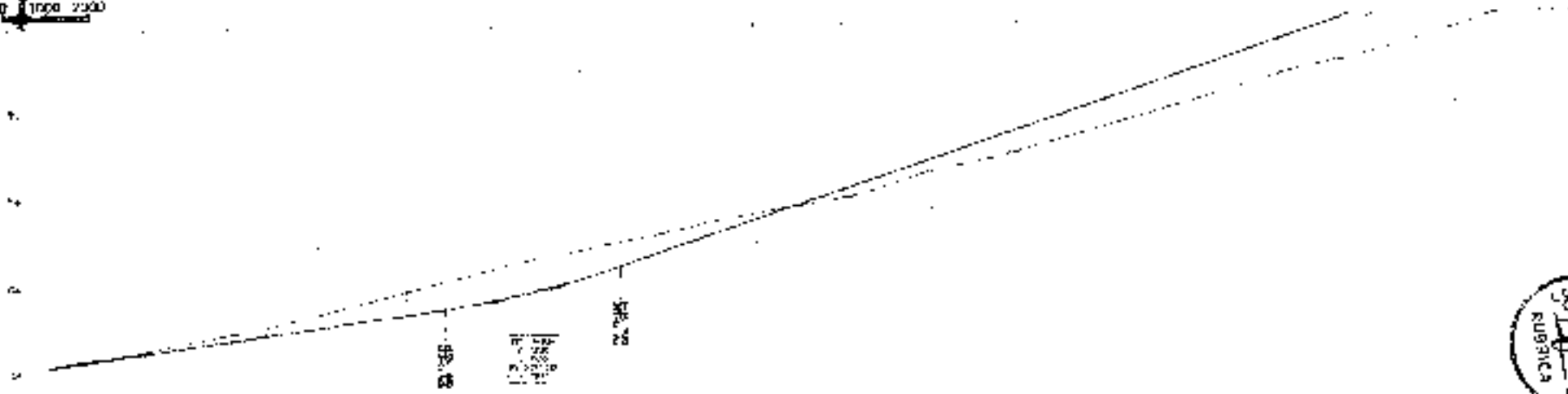

0+00	0+20	0+40	0+60	0+80	1+00	1+20	1+40	1+60	1+80	2+00	2+20	2+40	2+60	2+80	3+00	3+20	3+40	3+60	3+80	4+00	4+20
13.8	12.5	11.2	9.9	8.6	7.3	6.0	4.7	3.4	2.1	0.8	-0.5	-1.8	-3.1	-4.4	-5.7	-7.0	-8.3	-9.6	-10.9	-12.2	-13.5
13.8	12.5	11.2	9.9	8.6	7.3	6.0	4.7	3.4	2.1	0.8	-0.5	-1.8	-3.1	-4.4	-5.7	-7.0	-8.3	-9.6	-10.9	-12.2	-13.5



PREFEITURA MUNICIPAL DE GUARACIÁ DO NORTE	
RECONSTRUÇÃO DE ESTRADAS VIZINAS AO MUNICÍPIO DE GUARACIÁ DO NORTE - RGE - PT 1066210-00	
ESTAQUEAMENTO E PERFIL LONGITUDINAL	
PROJETA	ENC. TÉCNICA DE OBRAS RUAIS - JOTA BARROS
REVISOR	PROJ. CIVIL - JOTA BARROS



5 / 09
Escala
H 1:1000
V 1:100



PROF. DDA

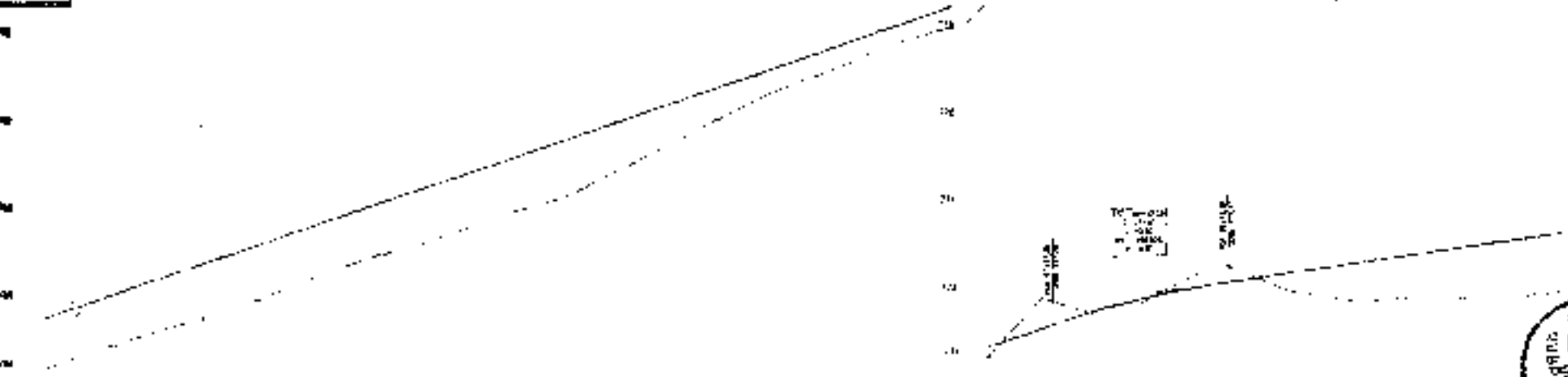

1	2	3	4	5	6	7	8	9	10	11	12	13	14	15	16	17	18	19	20	21	22	23	24	25	26	27	28	29	30	31	32	33	34	35	36	37	38	39	40	41	42	43	44	45	46	47	48	49	50	51	52	53	54	55	56	57	58	59	60	61	62	63	64	65	66	67	68	69	70	71	72	73	74	75	76	77	78	79	80	81	82	83	84	85	86	87	88	89	90	91	92	93	94	95	96	97	98	99	100	
0	1	2	3	4	5	6	7	8	9	10	11	12	13	14	15	16	17	18	19	20	21	22	23	24	25	26	27	28	29	30	31	32	33	34	35	36	37	38	39	40	41	42	43	44	45	46	47	48	49	50	51	52	53	54	55	56	57	58	59	60	61	62	63	64	65	66	67	68	69	70	71	72	73	74	75	76	77	78	79	80	81	82	83	84	85	86	87	88	89	90	91	92	93	94	95	96	97	98	99	100

CONCRETO	ASfalto	GRANULADO	SUBGRANULADO	ALCANTARAL	DESMATAMENTO	EMBOCALO	ENTALHO	MEIO-DIVISÓRIA	SINALIZAÇÃO



PREFEITURA MUNICIPAL DE GUARAJABA DO NORTE		6 / 09
RECUPERAÇÃO DE ESTRADAS VICINAIS NO MUNICÍPIO DE GUARAJABA DO NORTE - CE - PT. 106270-03		
ESTAQUEAMENTO E PERFIL LONGITUDINAL		
PROJETO:	PROJETO DE ESTACIONAMENTO E PERFIL LONGITUDINAL	DATA:
PROJETA:	JOTA BARROS	ESCALA:
PROJETO Nº:	106270-03	H. 111005

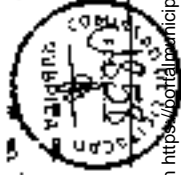

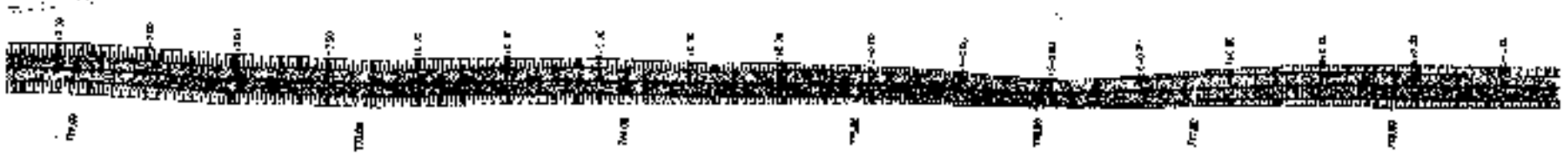

0 1000 2000
Metros

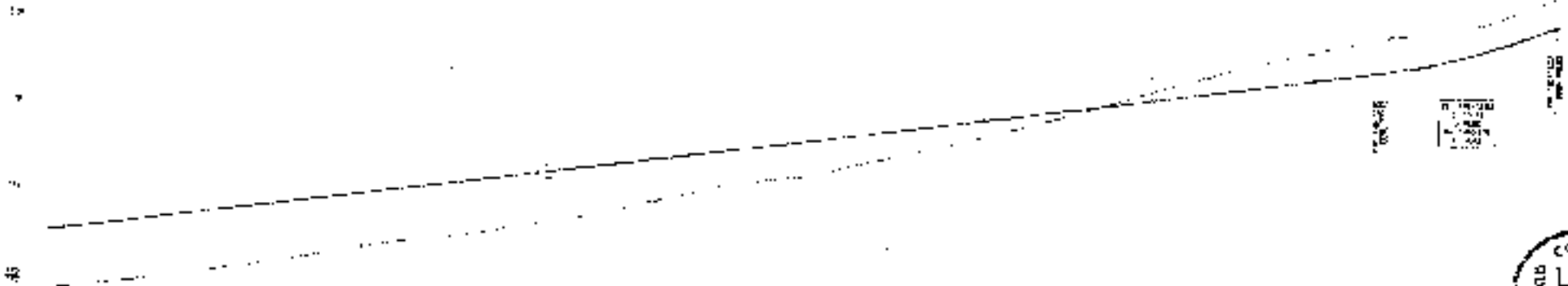

Estacão	0+00	0+20	0+40	0+60	0+80	1+00	1+20	1+40	1+60	1+80	2+00	2+20	2+40	2+60	2+80	3+00	3+20	3+40	3+60	3+80	4+00	4+20	4+40	4+60	4+80	5+00
Alt. Terreno	1.5	1.5	1.5	1.5	1.5	1.5	1.5	1.5	1.5	1.5	1.5	1.5	1.5	1.5	1.5	1.5	1.5	1.5	1.5	1.5	1.5	1.5	1.5	1.5	1.5	1.5
Alt. Projeto	1.5	1.5	1.5	1.5	1.5	1.5	1.5	1.5	1.5	1.5	1.5	1.5	1.5	1.5	1.5	1.5	1.5	1.5	1.5	1.5	1.5	1.5	1.5	1.5	1.5	1.5





JOTA BARROS
PROJETOS

PREFEITURA MUNICIPAL DE GUARACIABA DO NORTE

RECUPERAÇÃO DE ESTRADAS VICIAIS NO MUNICÍPIO DE GUARACIABA DO NORTE-CE - (PT 100027003)

ESTAQUEAMENTO E PERFIL LONGITUDINAL

PROJETO: ...

SCALE: ...

INSCRIÇÃO

7 / 09

ESCALA

H 1:1000

V 1:100



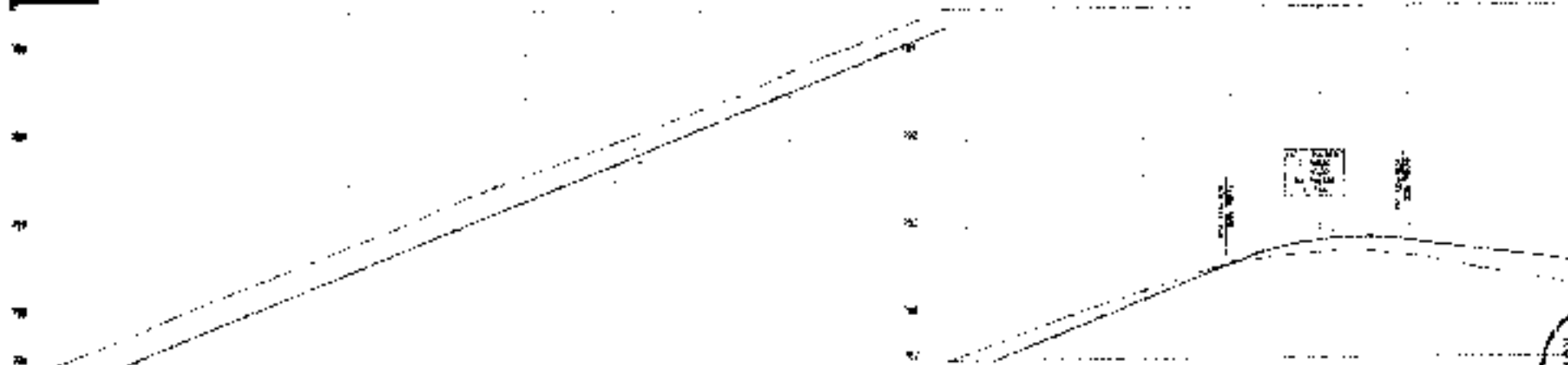
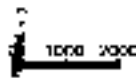

1+00	1+05	1+10	1+15	1+20	1+25	1+30	1+35	1+40	1+45	1+50	1+55	1+60	1+65	1+70	1+75	1+80	1+85	1+90	1+95	1+100
10	10	10	10	10	10	10	10	10	10	10	10	10	10	10	10	10	10	10	10	10
10	10	10	10	10	10	10	10	10	10	10	10	10	10	10	10	10	10	10	10	10
10	10	10	10	10	10	10	10	10	10	10	10	10	10	10	10	10	10	10	10	10

ASfalto	Concreto	Água	Sareia	Tijolo	Alvenaria	Solo	Vegetação



PREFEITURA MUNICIPAL DE GUARACABA DO NORTE	
RECUPERAÇÃO DE ESTRADAS VICINAIS NO MUNICÍPIO DE GUARACABA DO NORTE-CE - P1 1086270-03	
ESTAQUEAMENTO E PERFIL LONGITUDINAL	
PROJETO	DR. JOÃO CARLOS FERREIRA FERREIRA
ARQUITETO	INGENHEIRO CIVIL



8 / 09
 11.11.2009
 V. 1/100

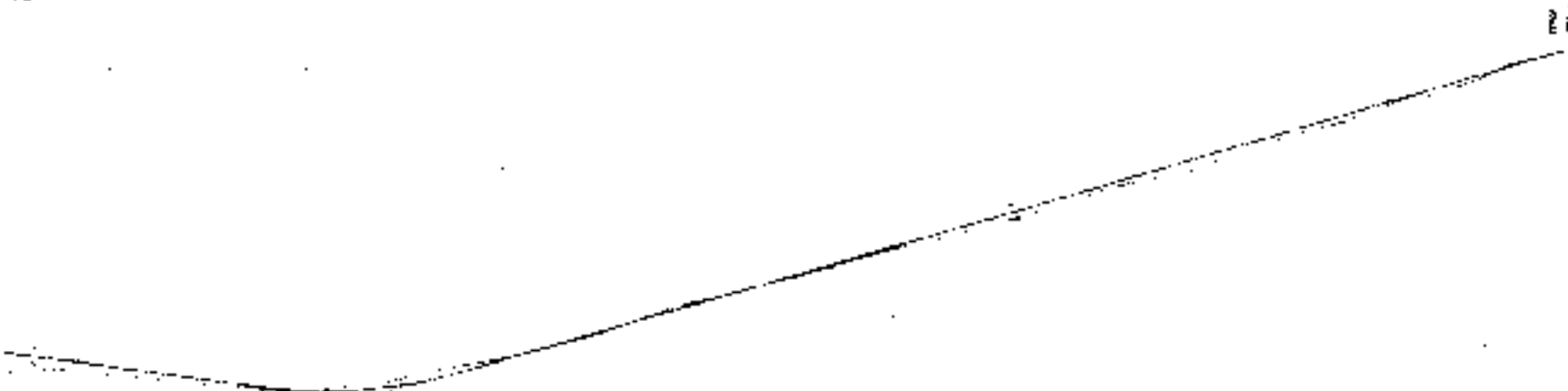
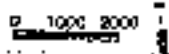
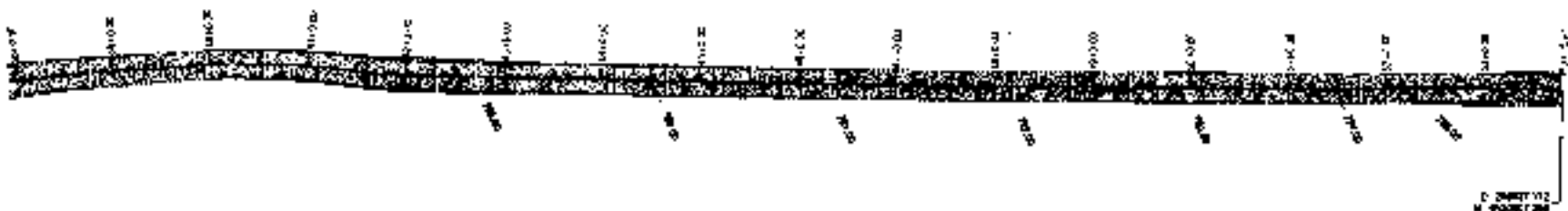

Estação	1+00	2+00	3+00	4+00	5+00	6+00	7+00	8+00	9+00	10+00	11+00	12+00	13+00	14+00	15+00	16+00	17+00	18+00	19+00	20+00	
ELV. TERRENO	120,50	118,00	116,50	115,00	113,50	112,00	110,50	109,00	107,50	106,00	104,50	103,00	101,50	100,00	98,50	97,00	95,50	94,00	92,50	91,00	89,50
ELV. PROJ.	115,00	115,00	115,00	115,00	115,00	115,00	115,00	115,00	115,00	115,00	115,00	115,00	115,00	115,00	115,00	115,00	115,00	115,00	115,00	115,00	115,00
ELV. C.A.M.	115,00	115,00	115,00	115,00	115,00	115,00	115,00	115,00	115,00	115,00	115,00	115,00	115,00	115,00	115,00	115,00	115,00	115,00	115,00	115,00	115,00
ELV. C.A.M. + 0,10	115,10	115,10	115,10	115,10	115,10	115,10	115,10	115,10	115,10	115,10	115,10	115,10	115,10	115,10	115,10	115,10	115,10	115,10	115,10	115,10	115,10
ELV. C.A.M. + 0,20	115,20	115,20	115,20	115,20	115,20	115,20	115,20	115,20	115,20	115,20	115,20	115,20	115,20	115,20	115,20	115,20	115,20	115,20	115,20	115,20	115,20
ELV. C.A.M. + 0,30	115,30	115,30	115,30	115,30	115,30	115,30	115,30	115,30	115,30	115,30	115,30	115,30	115,30	115,30	115,30	115,30	115,30	115,30	115,30	115,30	115,30
ELV. C.A.M. + 0,40	115,40	115,40	115,40	115,40	115,40	115,40	115,40	115,40	115,40	115,40	115,40	115,40	115,40	115,40	115,40	115,40	115,40	115,40	115,40	115,40	115,40
ELV. C.A.M. + 0,50	115,50	115,50	115,50	115,50	115,50	115,50	115,50	115,50	115,50	115,50	115,50	115,50	115,50	115,50	115,50	115,50	115,50	115,50	115,50	115,50	115,50

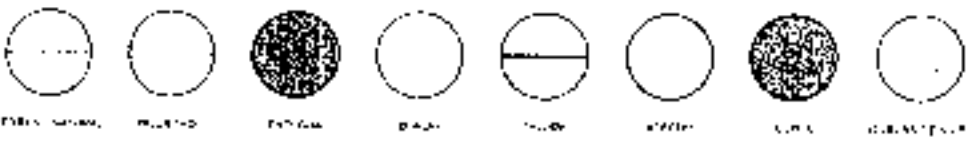

	PREFEITURA MUNICIPAL DE GUARACIABA DO NORTE		PARCELA
	RECUPERAÇÃO DE ESTRADAS VICINAIS NO MUNICÍPIO DE GUARACIABA DO NORTE-CE - P/L 108270-03		9 / 09
	ESTAQUEAMENTO E PERFIL LONGITUDINAL		ESCALA
HORAS	100	100	H 1:1000
VALORES	1000	1000	V 1:100

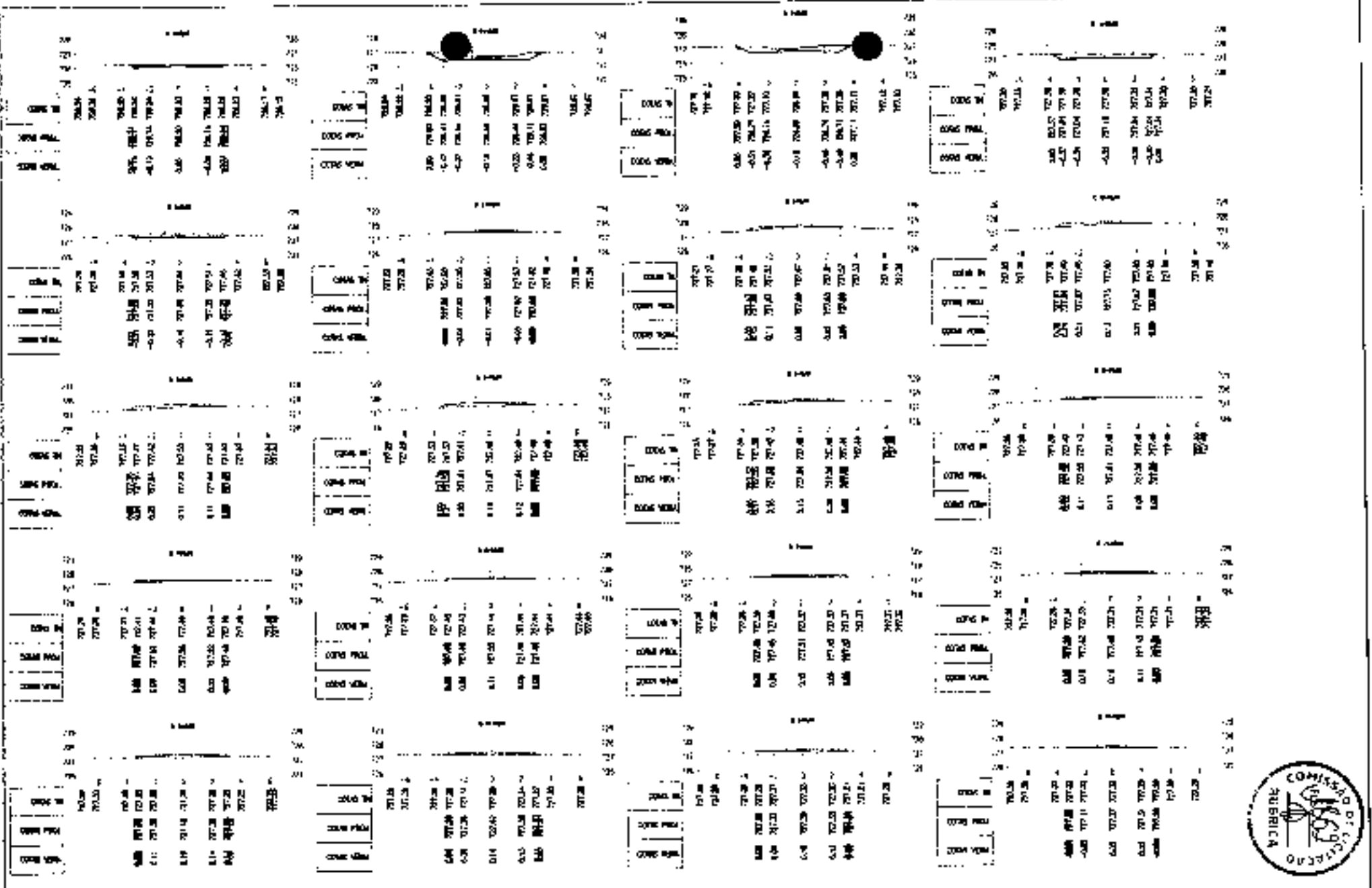

LEGENDA

 ATERRO

 CORTE



PRES. LITURA MUNICIPAL DE GUARACIABA DO NORTE

RECUPERAÇÃO DE ESTRADAS VICINAIS AO MUNICÍPIO DE GUARACIABA DO NORTE-CE - PI 1086270-03

SEÇÕES TRANSVERSAIS

PROJETO DE RECUPERAÇÃO DE ESTRADAS VICINAIS AO MUNICÍPIO DE GUARACIABA DO NORTE-CE - PI 1086270-03

PROJETO DE RECUPERAÇÃO DE ESTRADAS VICINAIS AO MUNICÍPIO DE GUARACIABA DO NORTE-CE - PI 1086270-03



1 / 18

1250

LEGENDA

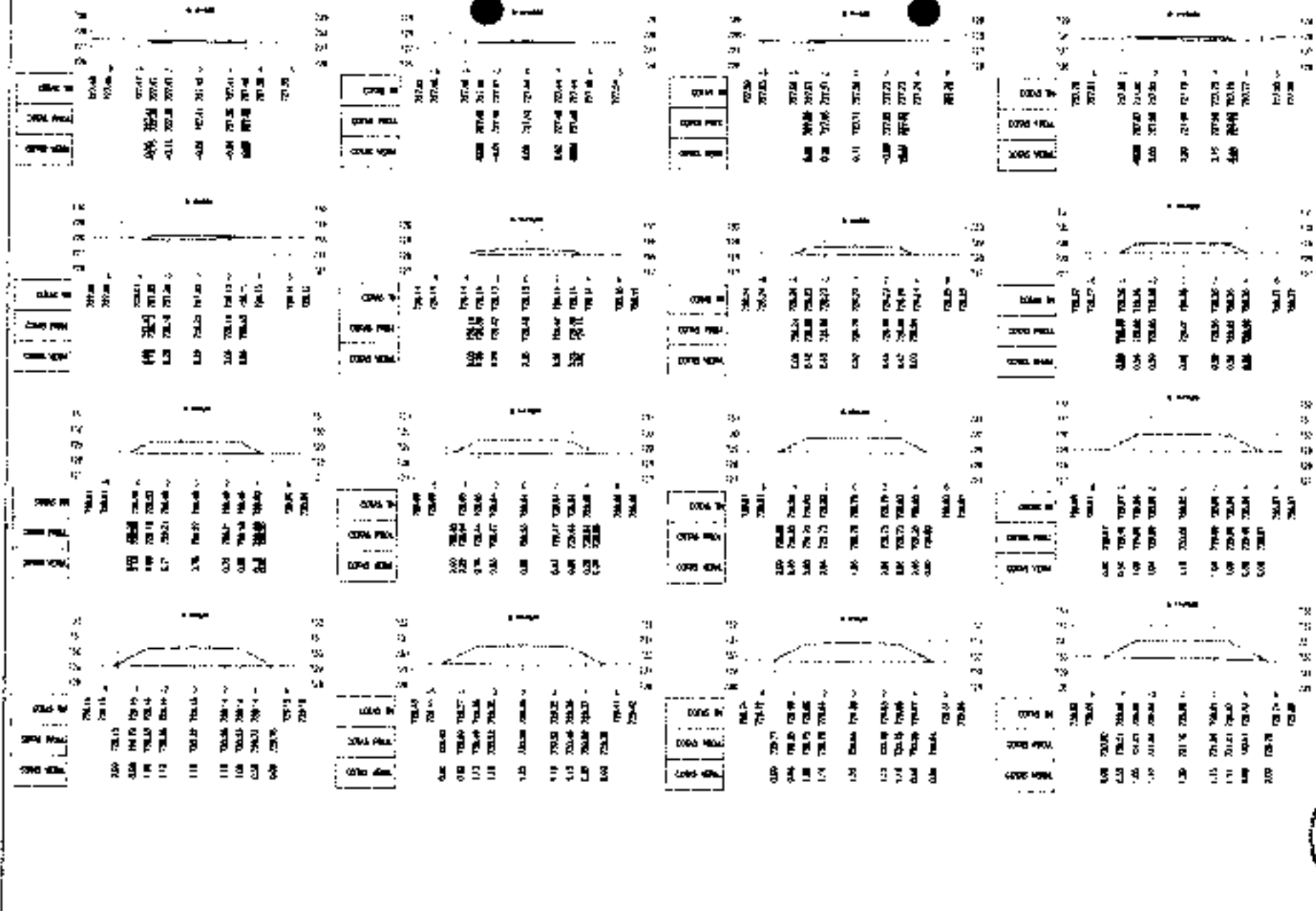
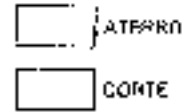

	PREFEITURA MUNICIPAL DE GUARACIABA DO NORTE RECUPERAÇÃO DE ESTRADAS VICINAIS NO MUNICÍPIO DE GUARACIABA DO NORTE - CE - PT 10862/0-03		FOLHA Nº 2 / 19
	SEÇÕES TRANSVERSAIS		ESCALA 1:250
	DATA 10/01/2011	LOCAL GUARACIABA DO NORTE - CE	PROJETO ENG. CIVIL



LEGENDA:

-  ATERRO
-  CORTE

 <p>JOTA BARROS PROJETO</p>	PREFEITURA MUNICIPAL DE GUARACIABA DO NORTE RECUPERAÇÃO DE ESTRADAS VICINAIS NO MUNICÍPIO DE GUARACIABA DO NORTE-CE - PT 1086270-03		Nº 4 / 18
	SEÇÕES TRANSVERSAIS		
	ESCALA: 1:1000 DATA: 10/05/2011	PROJ. EXECUTIVO: JOTA BARROS PROJ. EXECUTIVO: JOTA BARROS	DATA: 10/05/2011

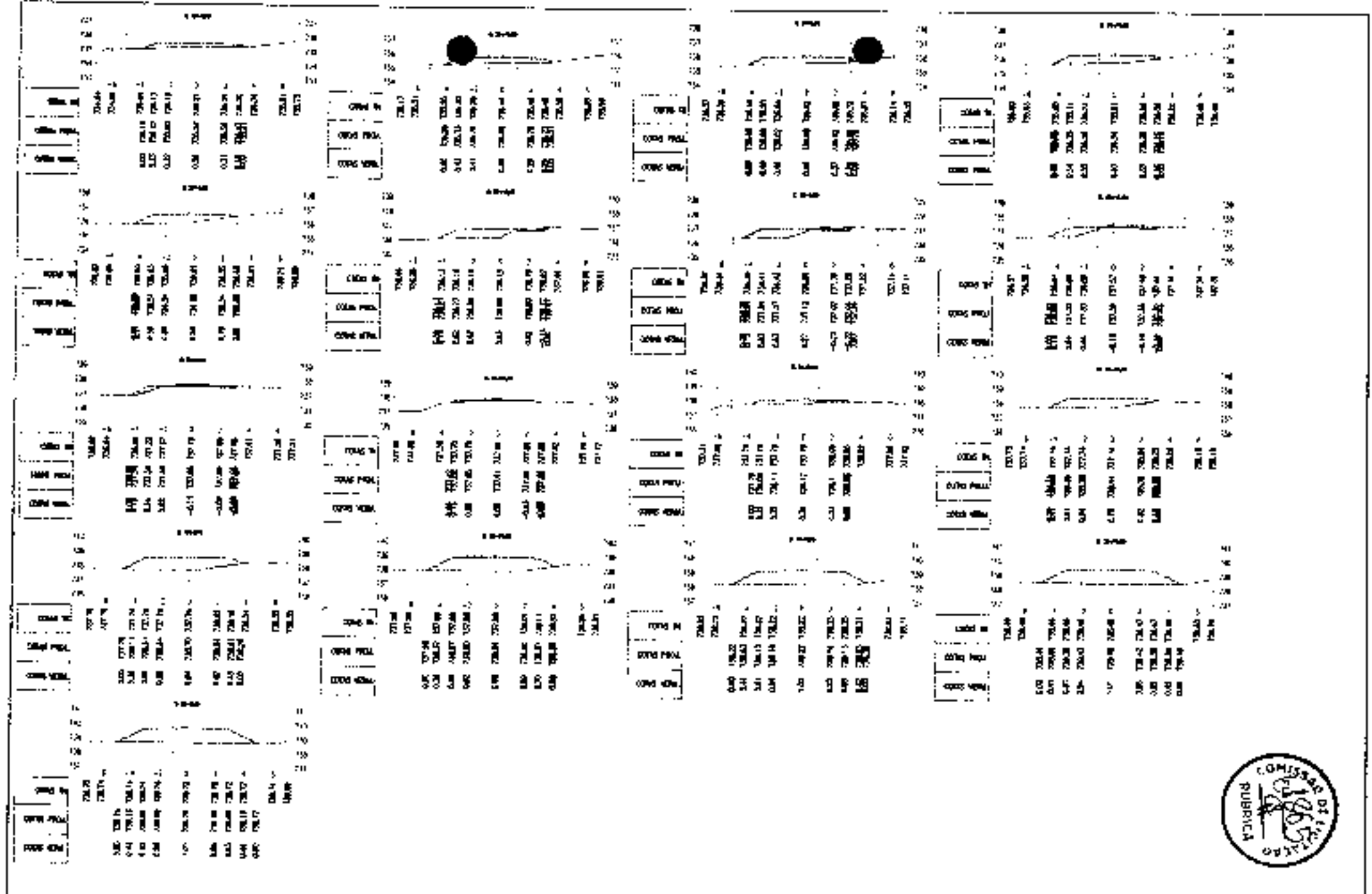

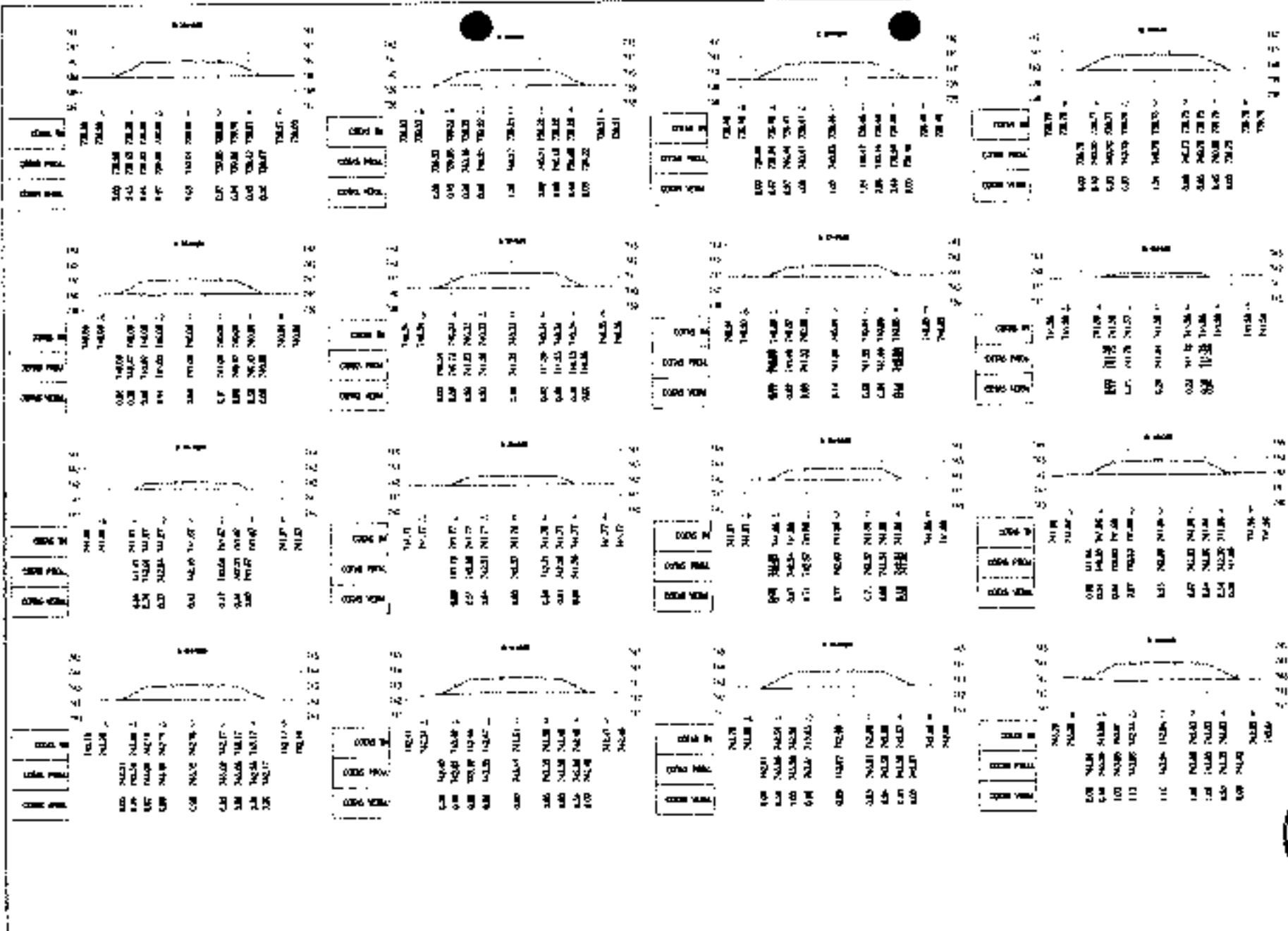



LEGENDA:

ATERRO

CORTE

<p>JOTA BARROS PROFELDT</p>	<p>PREFETURA MUNICIPAL DE GUARACIABA DO NORTE, RECUPERAÇÃO DE ESTRADAS VICINAIS NO MUNICÍPIO DE GUARACIABA DO NORTE-CE - PT 1036270-03</p>		<p>FOLHA Nº 5 / 18</p>
	<p>SEÇÕES TRANSVERSAIS</p>		<p>DATA 12/05/2011</p>
<p>PROJETO</p>	<p>RECUPERAÇÃO DE ESTRADAS VICINAIS NO MUNICÍPIO DE GUARACIABA DO NORTE-CE - PT 1036270-03</p>		<p>ESCALA 1:250</p>
<p>ANEXO</p>	<p>SEÇÃO TRANSVERSAIS</p>		

LEGENDA

-  ATERRO
-  CORTE

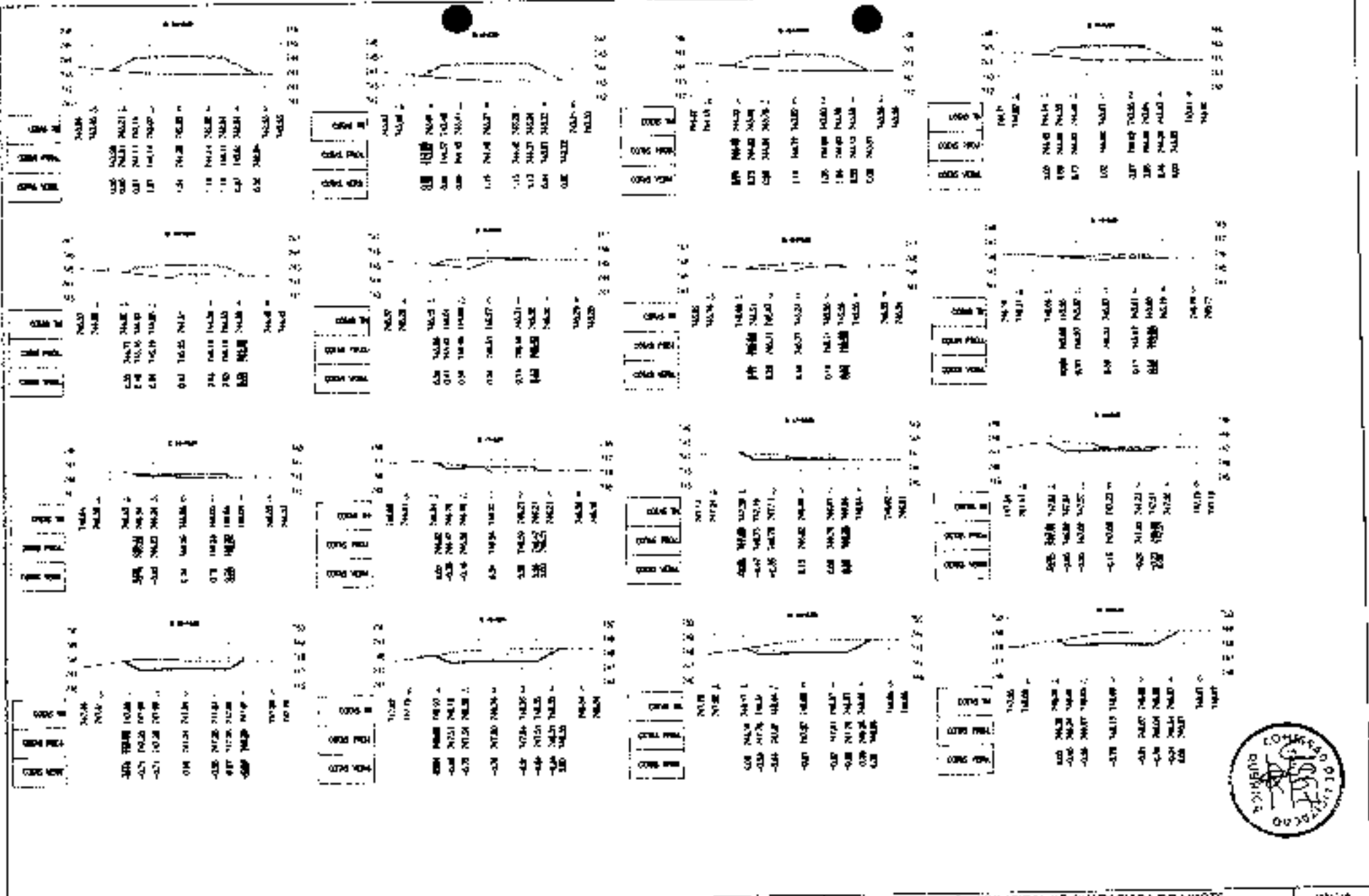

	PREFEITURA MUNICIPAL DE GUARACIABA DO NORTE RECUPERAÇÃO DE ESTRADAS VICINAIS NO MUNICÍPIO DE GUARACIABA DO NORTE-CE - PT 1066270-03 SEÇÕES TRANSVERSAIS		Nº 6 / 18
	DATA DE EMISSÃO DO PROJETO: 10/05/2010		ESCALA: 1/250
	DATA DE APROVAÇÃO DO PROJETO: 10/05/2010		

LEGENDA

-  ATERRO
-  CONTE

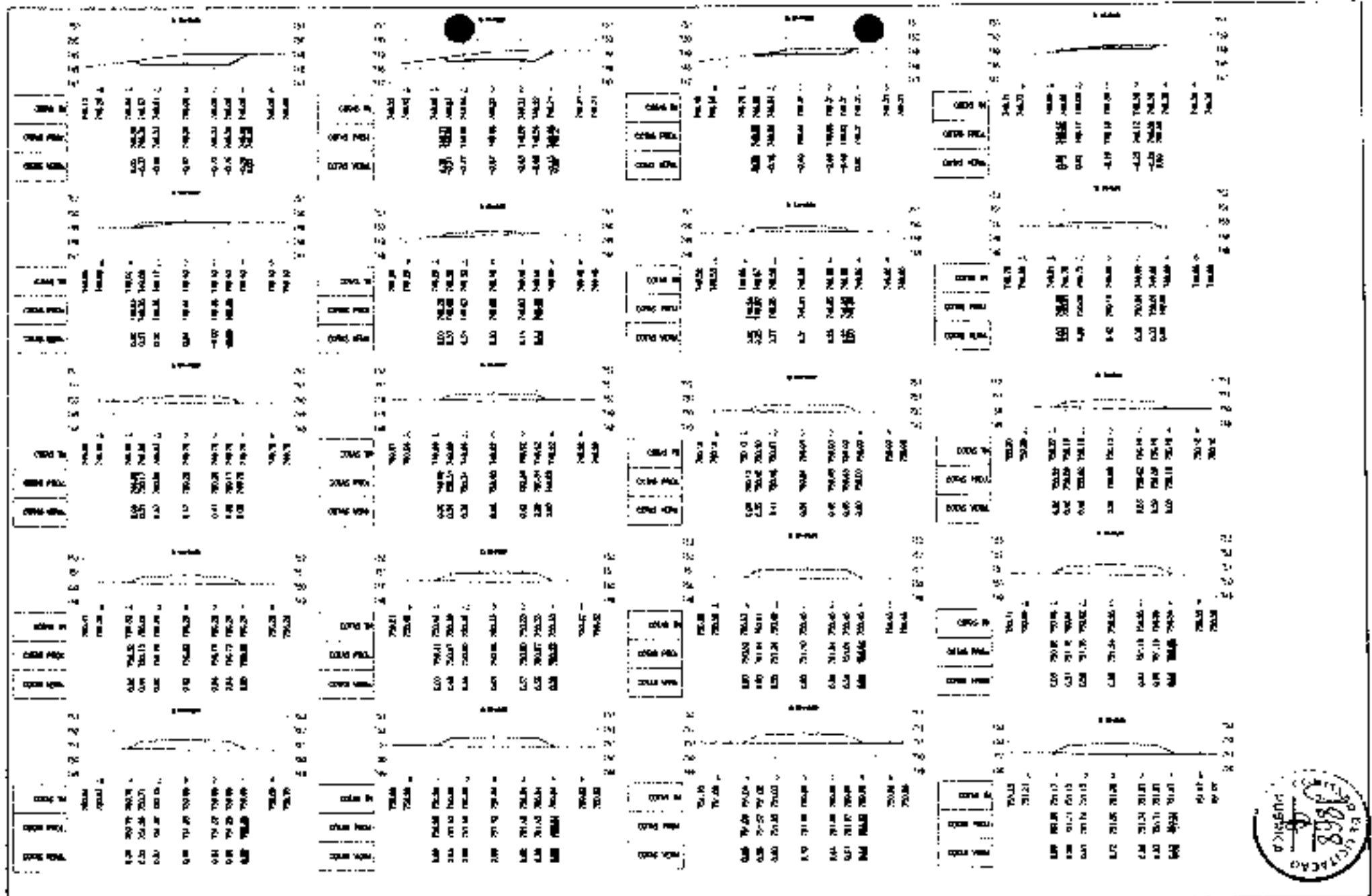

 <p>JOTA BARROS Engenharia Civil</p>	<p>PREFEITURA MUNICIPAL DE GUARACIABA DO NORTE RECUPERAÇÃO DE ESTRADAS VICINAIS NO MUNICÍPIO DE GUARACIABA DO NORTE-CE - PT 10882/0-03</p>		<p>7 / 18</p>
	<p>SEÇÕES TRANSVERSAIS</p>		<p>1:250</p>



LEGENDA:

-  ATERRO
-  CORTE

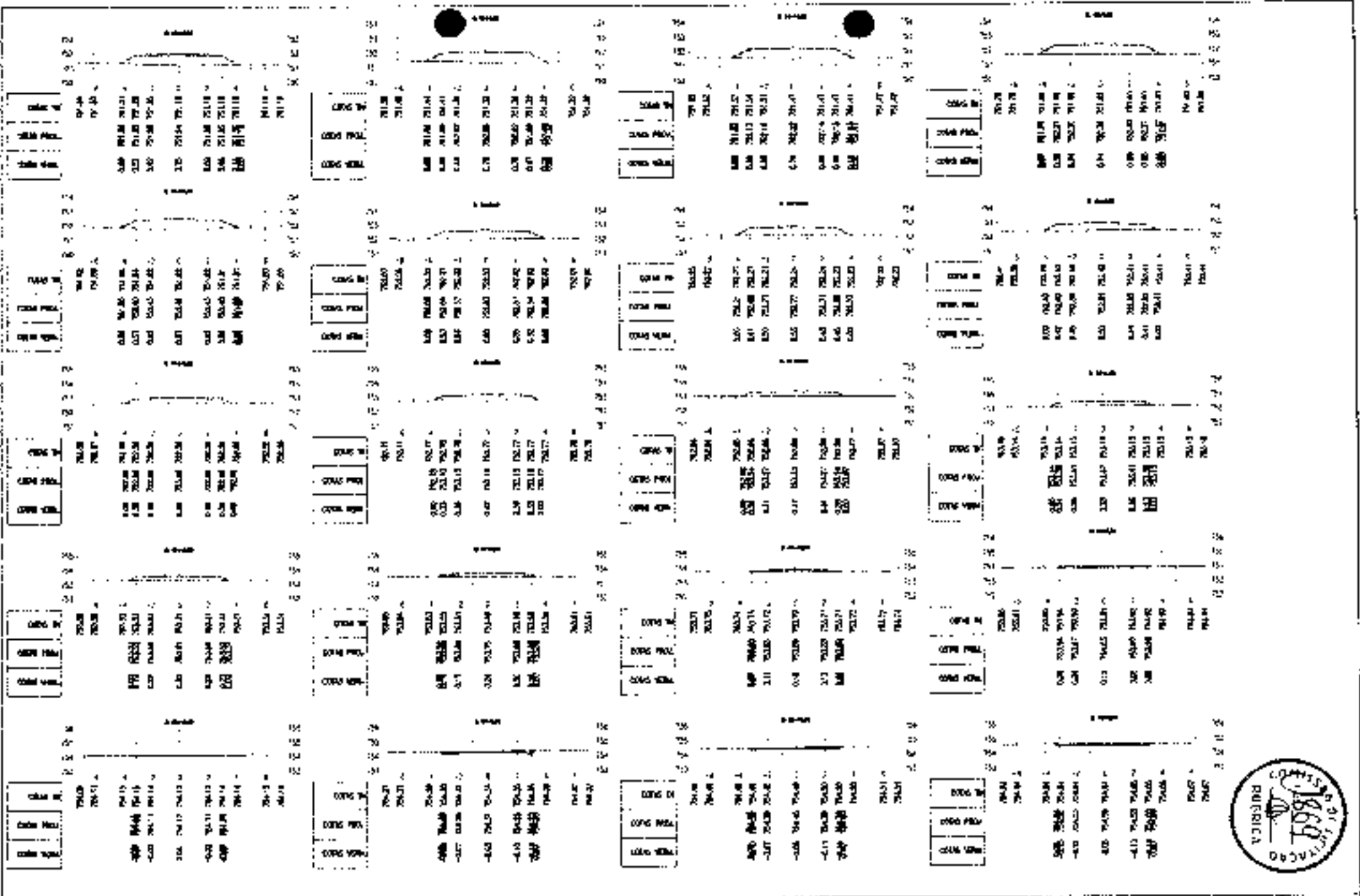

PREFEITURA MUNICIPAL DE GUARACIABA DO NORTE	
RECUPERAÇÃO DE ESTRADAS VICINAIS NO MUNICÍPIO DE GUARACIABA DO NORTE-CE - PT 10R6270-03	
SEÇÕES TRANSVERSAIS	
1:100	1:100
1:100	1:100
1:100	1:100



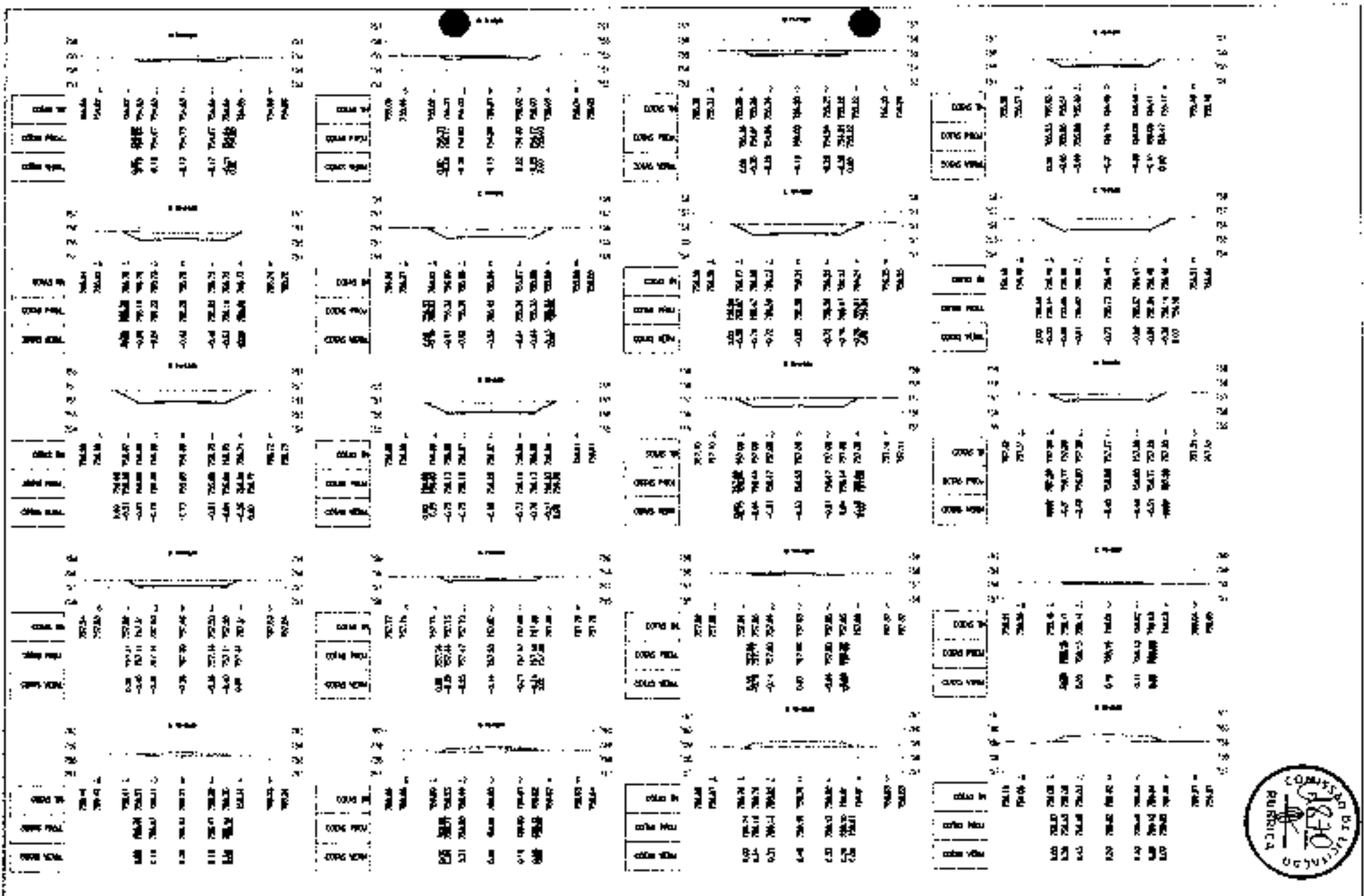

LEGENDA:

- ALICERÇO
- CORTIÇA



PREFEITURA MUNICIPAL DE GUARACIMBA DO NORTE.
 RECUPERAÇÃO DE ESTRADAS VICINAIS NO MUNICÍPIO DE GUARACIMBA DO NORTE - CE - PT 1006270-00
 SEÇÕES TRANSVERSAIS

NUM. P.	9 / 18
DATA	1/200



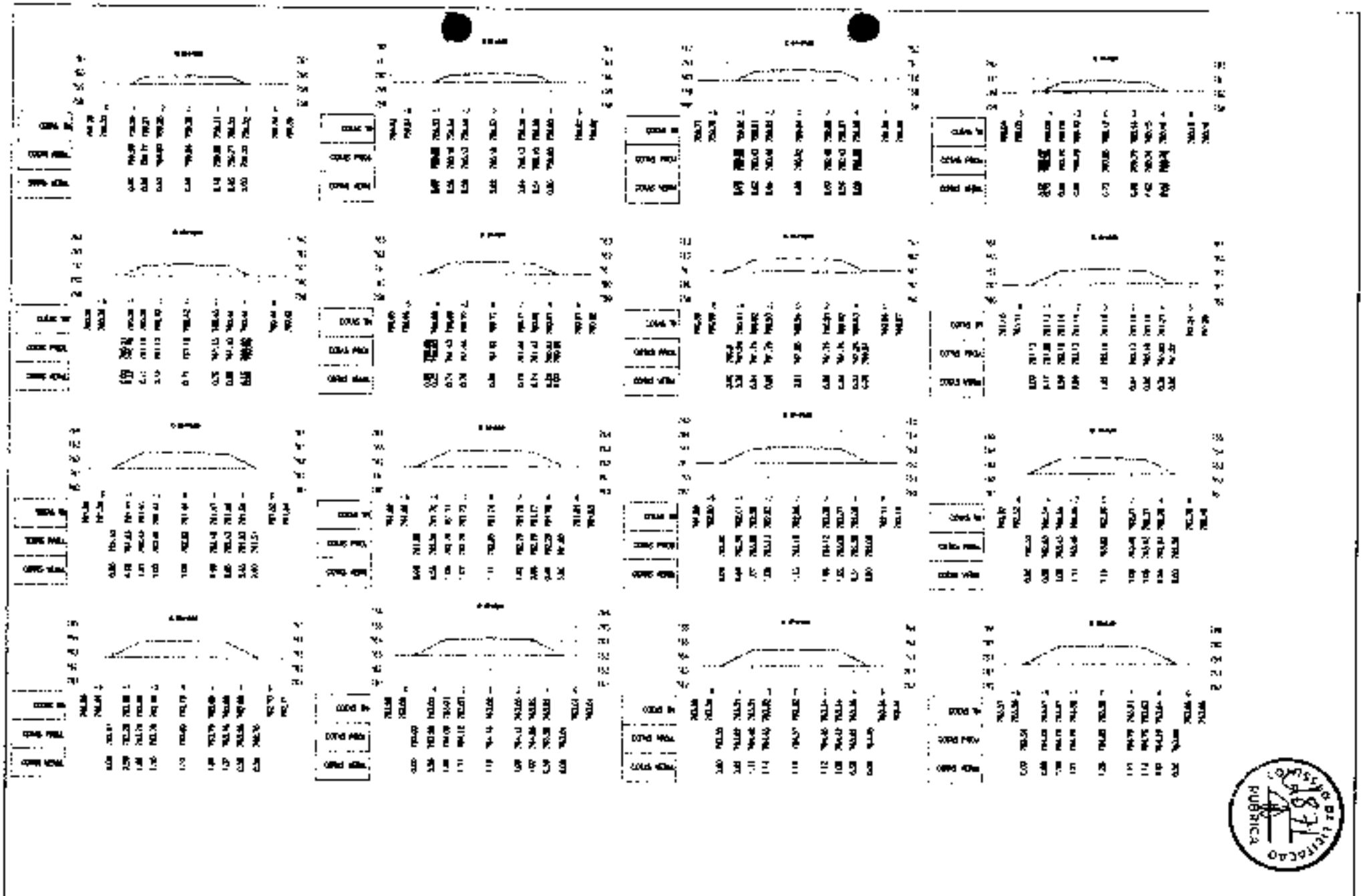

LEGENDA:

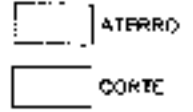



JOTA BARROS
PROJETOS

PREFEITURA MUNICIPAL DE GUARACIABA DO NORTE

RECUPERAÇÃO DE ESTRADAS VICINAIS NO MUNICÍPIO DE GUARACIABA DO NORTE-CE - PT 10R6270-03

SEÇÕES TRANSVERSAIS

10 / 18

1:250



LEGENDA:

-  ATERRO
-  CURTE



PREFEITURA MUNICIPAL DE GIARACIARA DO NORTE.		PLANO
RECUPERAÇÃO DE ESTRADAS VICINAIS NO MUNICÍPIO DE GIARACIARA DO NORTE-CE - PT. 1086773-05		11 / 18
SEÇÕES TRANSVERSAIS		
PROJETO	ENGENHEIRO RESPONSÁVEL: ENG. ENR 150623-1	DATA
APROVADO	PROFESSOR RESPONSÁVEL:	1/2020

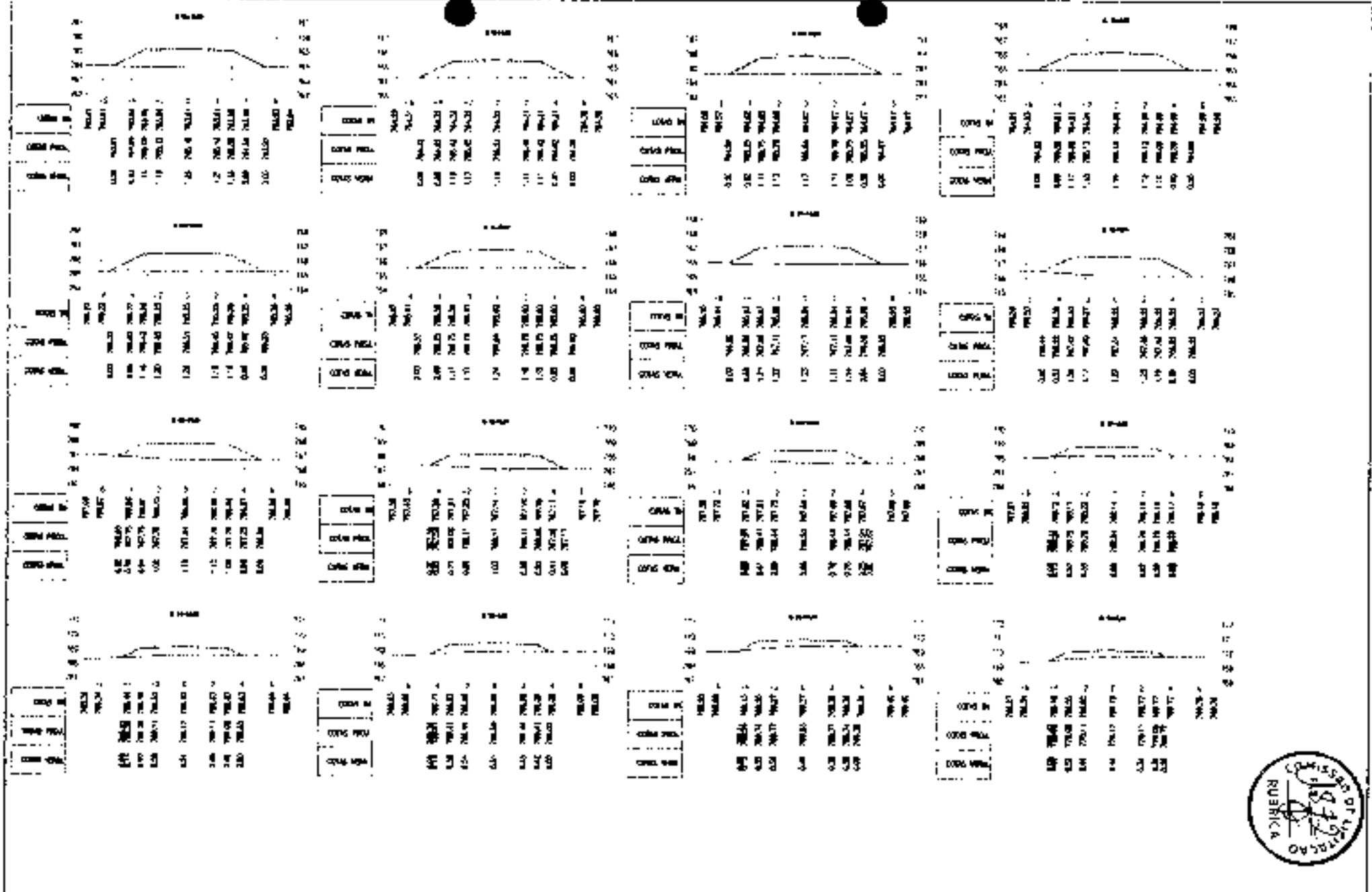

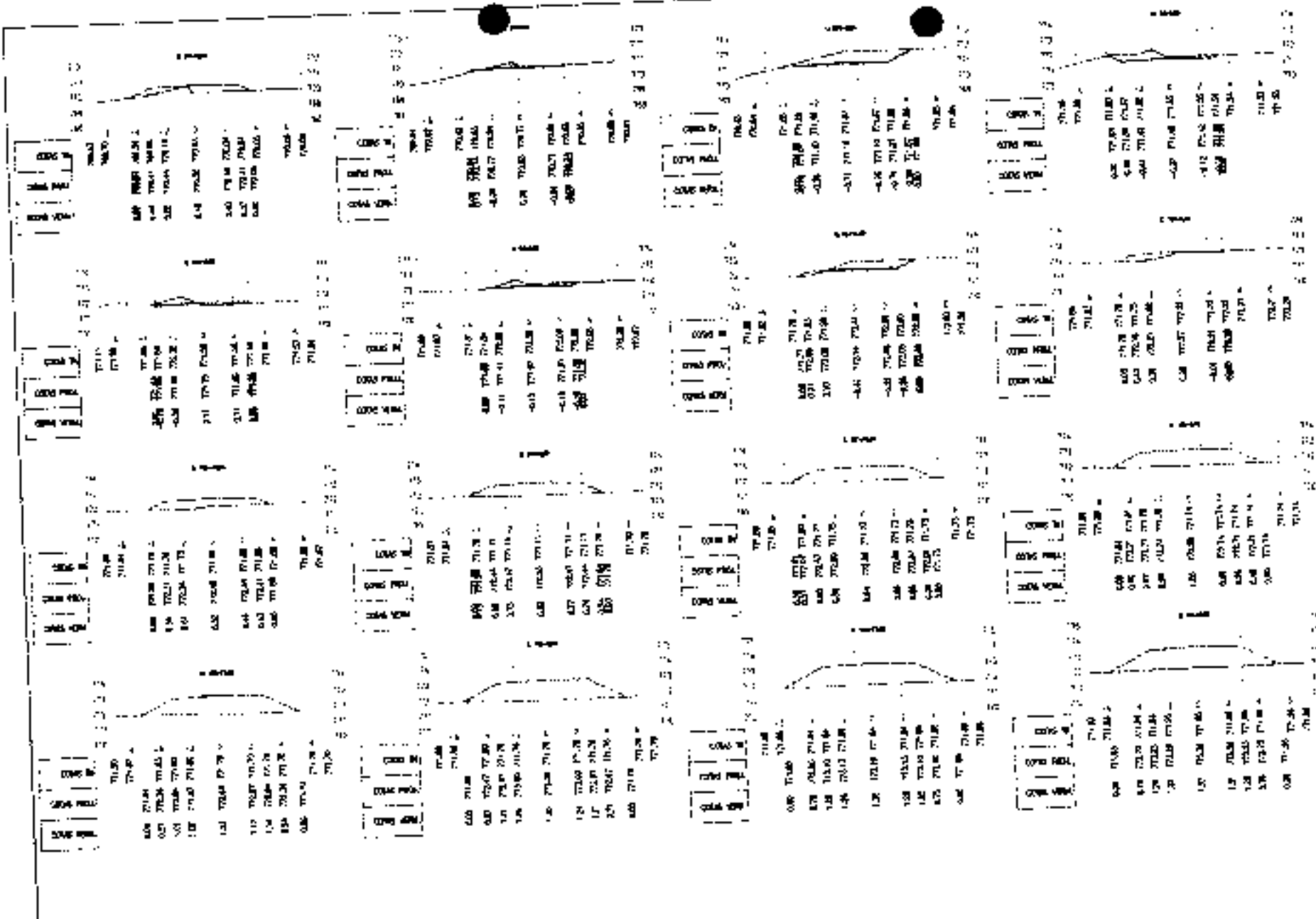

LEGENDA:

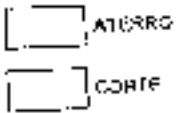



PREFEITURA MUNICIPAL DE GUARACIABA DO NORTE
 RECUPERAÇÃO DE ESTRADAS VICINAIS NO MUNICÍPIO DE GUARACIABA DO NORTE-CE - PT 1085270-03
 SEÇÕES TRANSVERSAIS

12 / 18
 1:250



LEGENDA

-  ATERRO
-  CORTE



PREFEITURA MUNICIPAL DE GUARACIABA DO NORTE.
 RECUPERAÇÃO DE ESTRADAS URBANAS NO MUNICÍPIO DE GUARACIABA DO NORTE-CE - PI 1086270-03
 SEÇÕES TRANSVERSAIS

13 / 18
 1:250

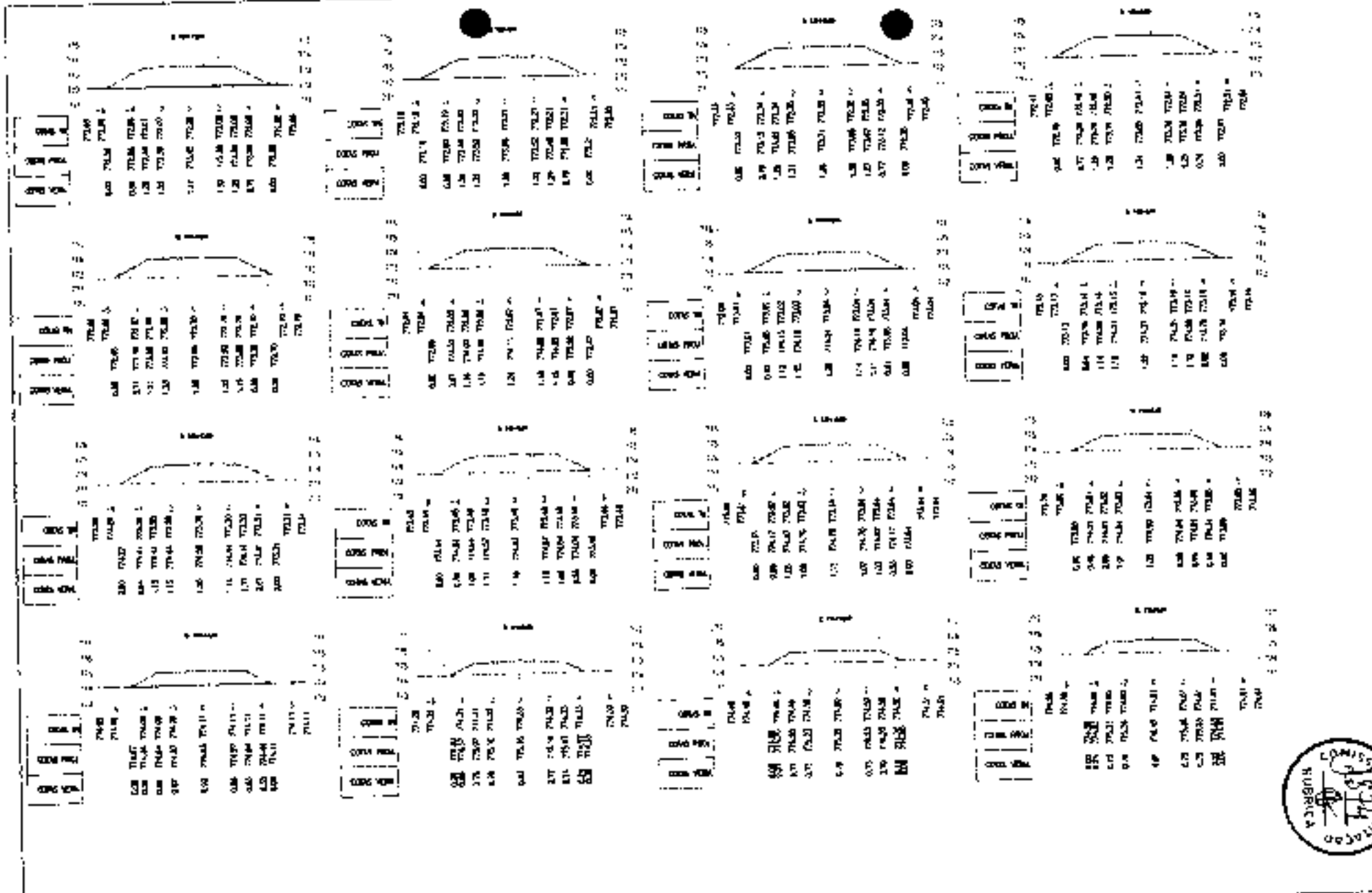

IDENTIFICA

 ATERRO
 CORTIÇ

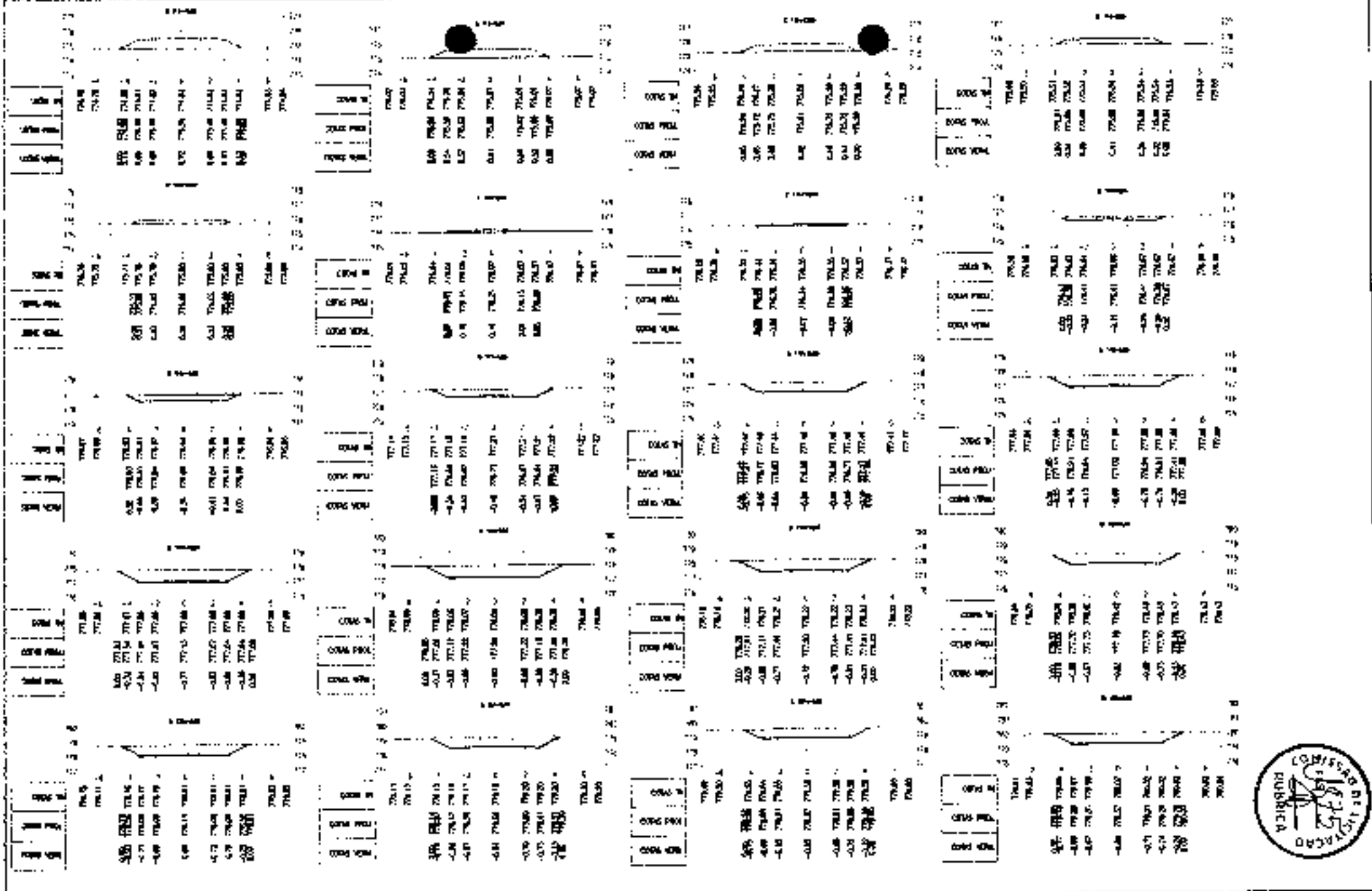

	PREFEITURA MUNICIPAL DE QUARACUBA DO NORTE		14 / 18
	RECUPERAÇÃO DE ESTRADAS VICINAIS NO MUNICÍPIO DE QUARACUBA DO NORTE - CE - PT 1386273-03		1/250
	SEÇÕES TRANSVERSAIS		
	PROJETO DE ARQUITETURA E LAYOUT		



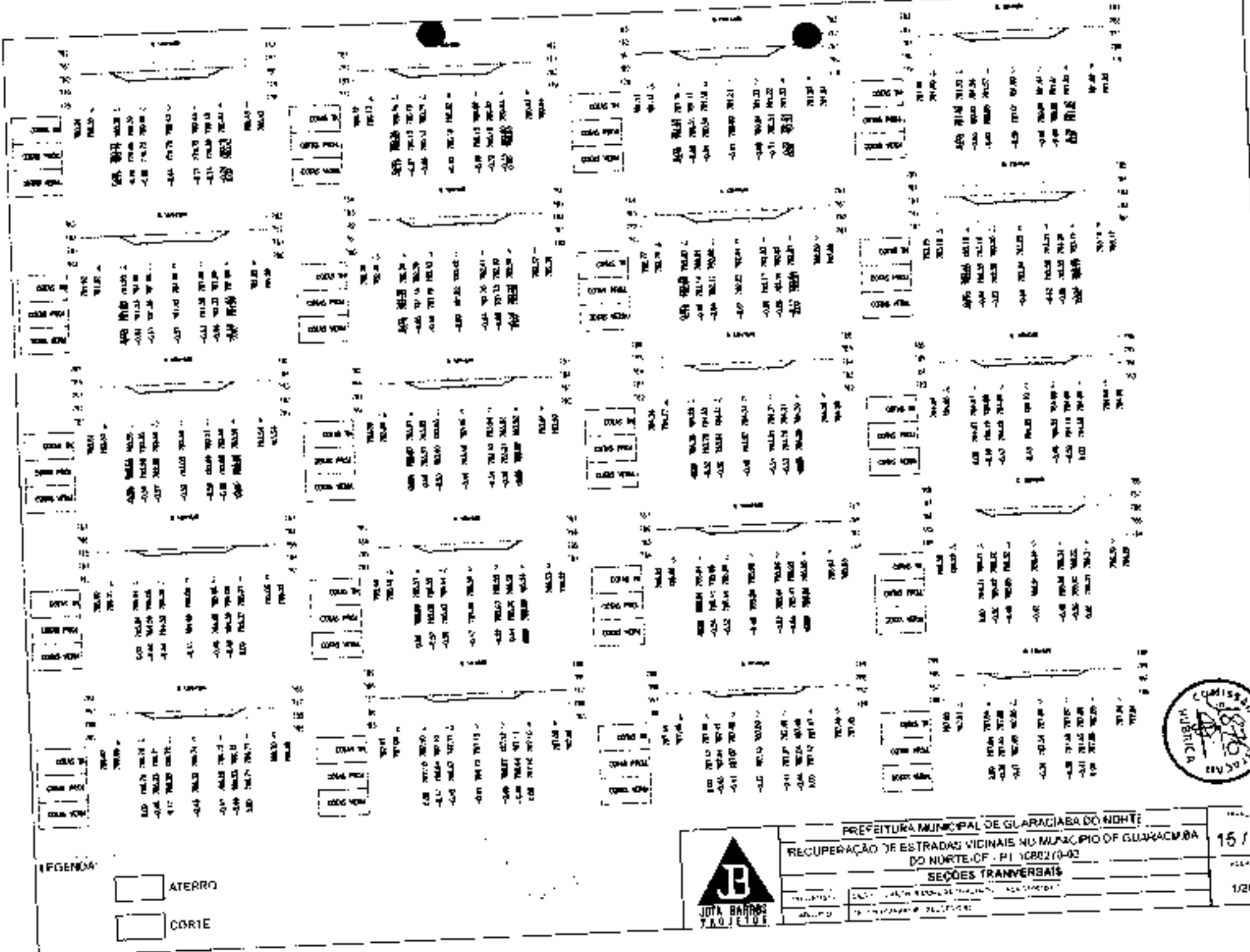

PREFEITURA MUNICIPAL DE GLARACIABA DO NORTE
 RECUPERAÇÃO DE ESTRADAS VICINAIS NO MUNICÍPIO DE GLARACIABA
 DO NORTE-CF - PI - CR21/0-02
 SEÇÕES TRANSVERSAIS



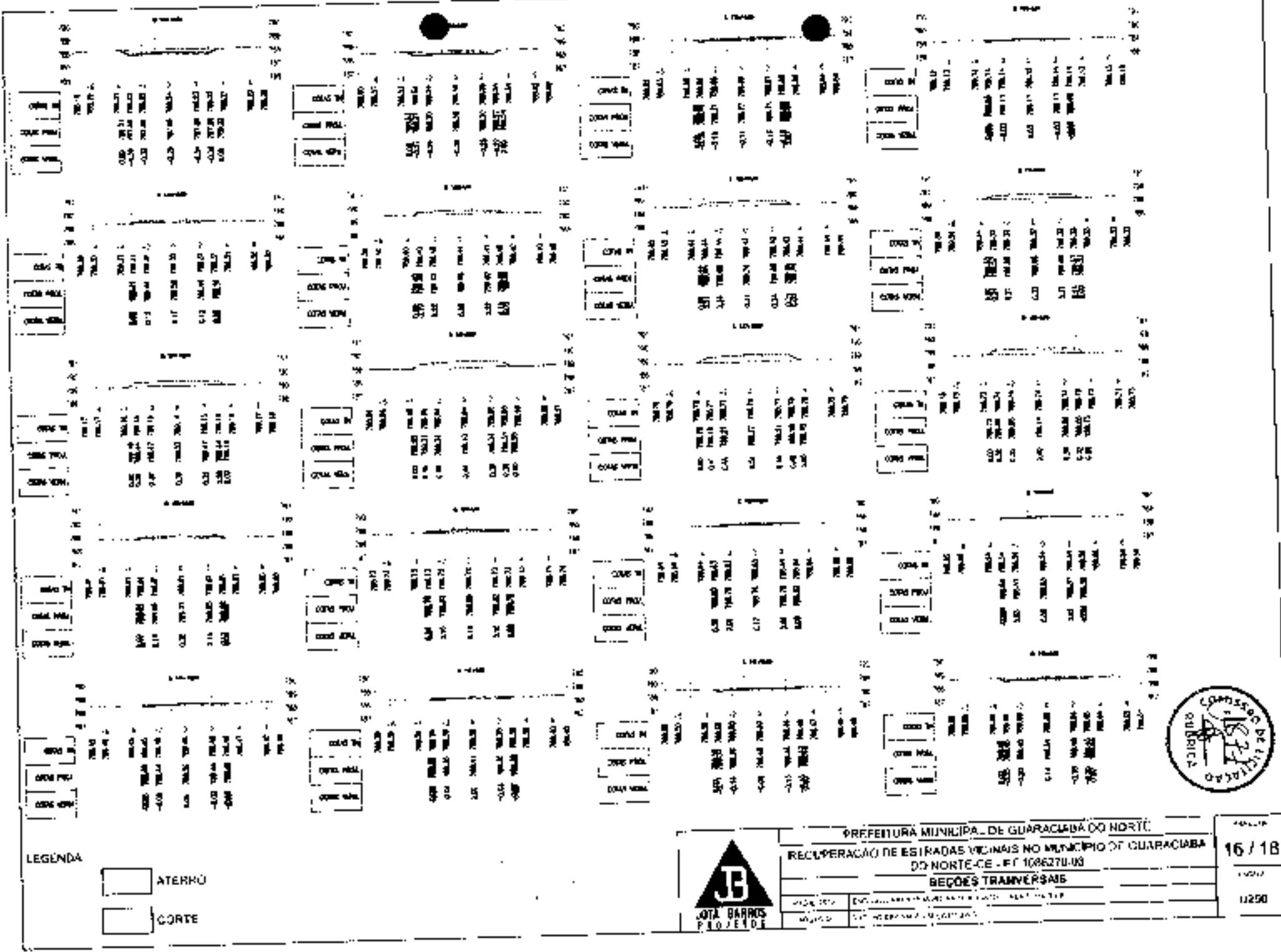

LEGENDA

-  ATERRO
-  CORTE





PREFEITURA MUNICIPAL DE GUARACIABA DO NORTE
 RECUPERAÇÃO DE ESTRADAS VICINAIS NO MUNICÍPIO DE GUARACIABA DO NORTE-CE - PI 1086270-03
 BECÕES TRANSVERSAIS

16 / 18
 11250

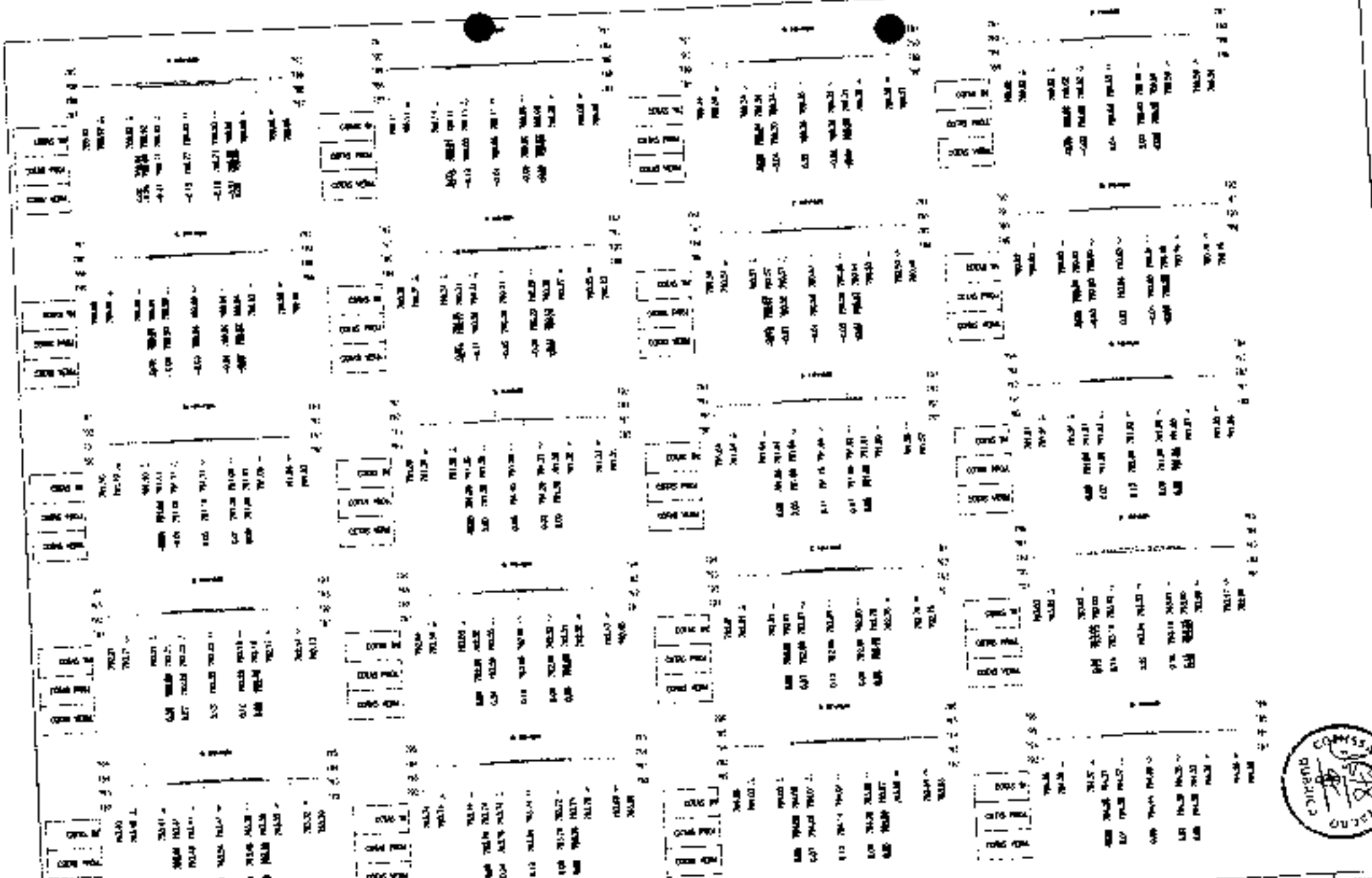



LEGENDA

-  ALBERGO
-  CARRE



PREFEITURA MUNICIPAL DE GUARACIABA DO NORTE.
 RECUPERAÇÃO DE ESTRADAS VICINAIS NO MUNICÍPIO DE GUARACIABA DO NORTE-CE - AT 108627-03
 SEÇÕES TRANSVERSAIS

17 / 18
 11250



LEGENDA

-  ATERRO
-  CORTE

 <p>JOTA BARROS ENGENHARIA</p>	PREFEITURA MUNICIPAL DE GUARACIABA DO NORTE RECUPERAÇÃO DE ESTRADAS VICINAIS NO MUNICÍPIO DE GUARACIABA DO NORTE-CE - PT 1086270-03 SEÇÕES TRANSVERSAIS		FOLHA Nº 18 / 18
	ESCALA: 1:250		1:250

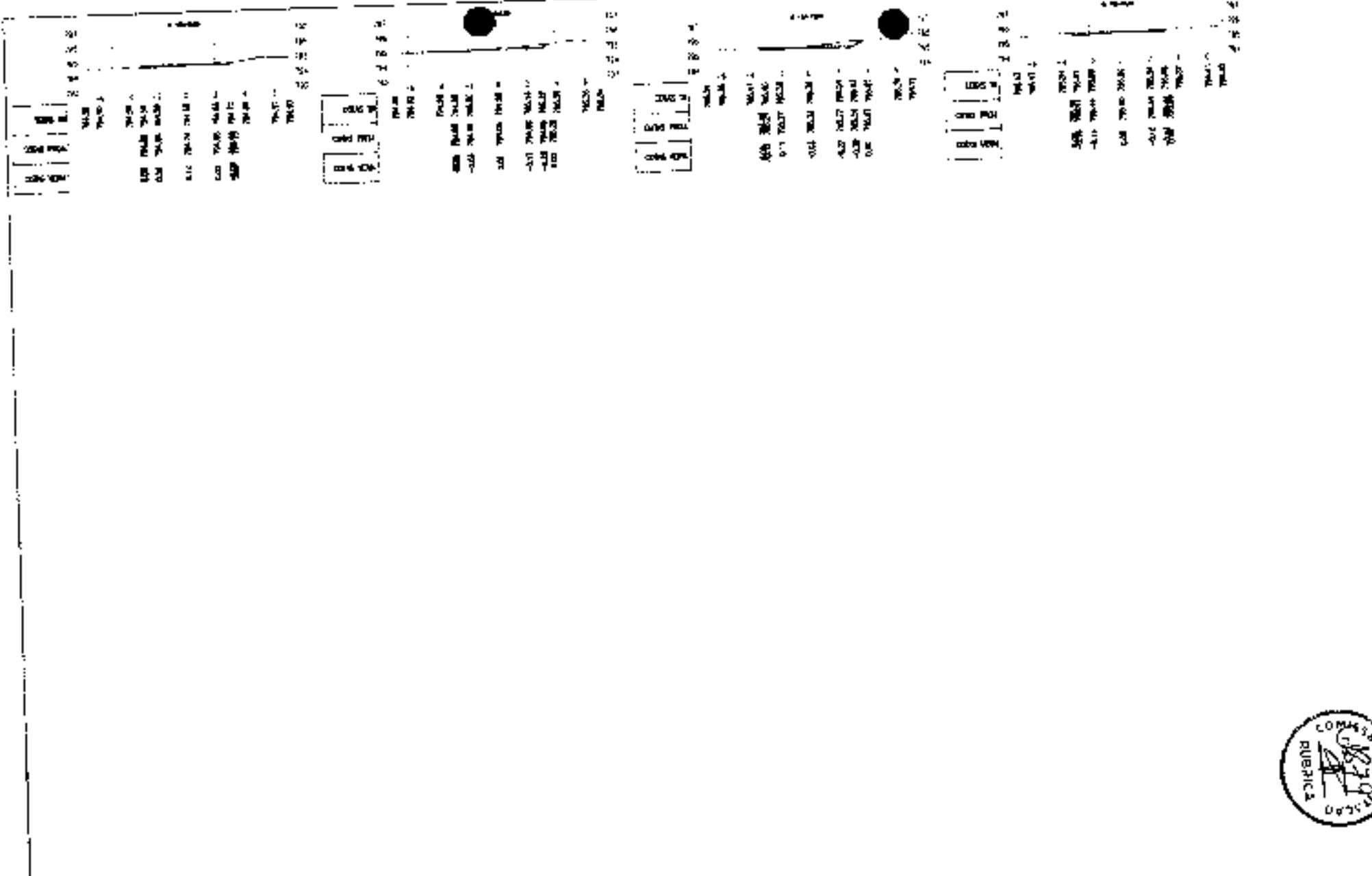

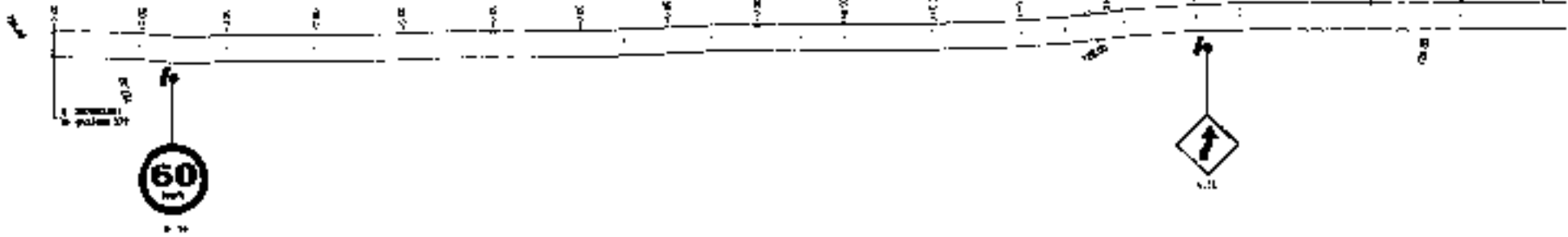
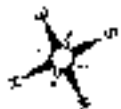

0 1000 2000

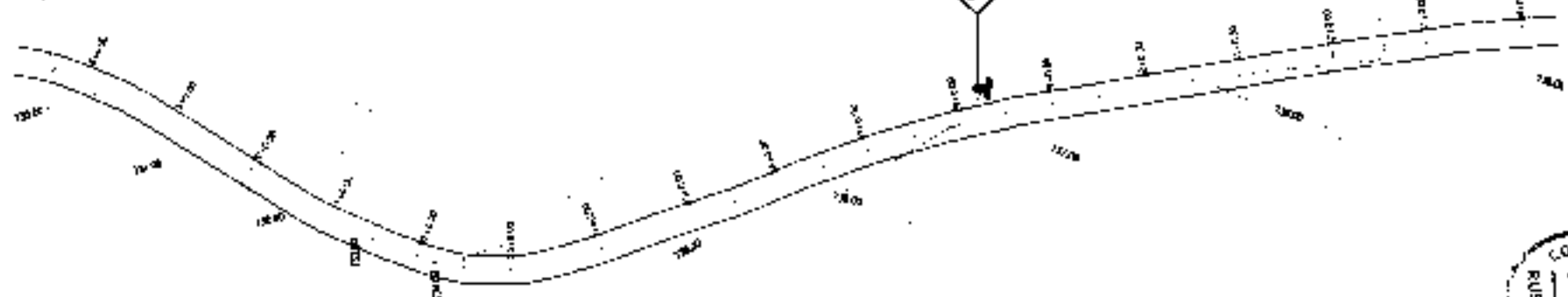

0 1000 2000



PREFEITURA MUNICIPAL DE GUARACIABA DO NORTE	
RECUPERAÇÃO DE ESTRADAS VICINAIS NO MUNICÍPIO DE GUARACIABA DO NORTE - CE - DT 18802/0-03	
SINALIZAÇÃO VIÁRIA	
PROJETO	COM. DE MEIO AMBIENTE E QUALIDADE DE VIDA
PROJETO	PROJ. DE SINALIZAÇÃO VIÁRIA

1 / 06
1:1000



0 1000 2000

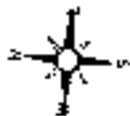

0 1000 2000

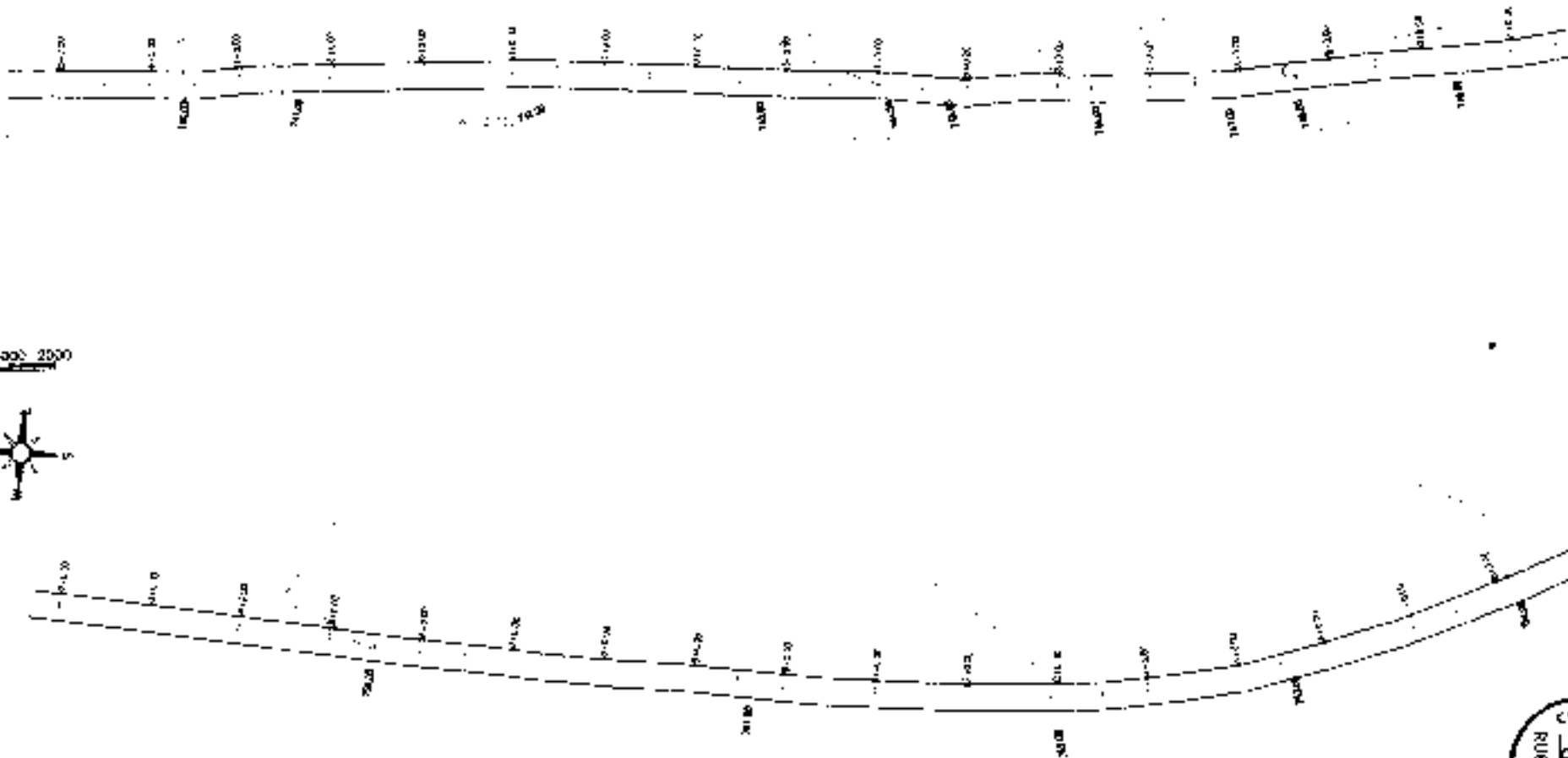

PREFEITURA MUNICIPAL DE GUARACIABA DO NORTE
 RECUPERAÇÃO DE ESTRADAS VICINAS NO MUNICÍPIO DE GUARACIABA DO NORTE - CE - Nº 10652/03-03
 SINALIZAÇÃO VIÁRIA

2 / 05
11000

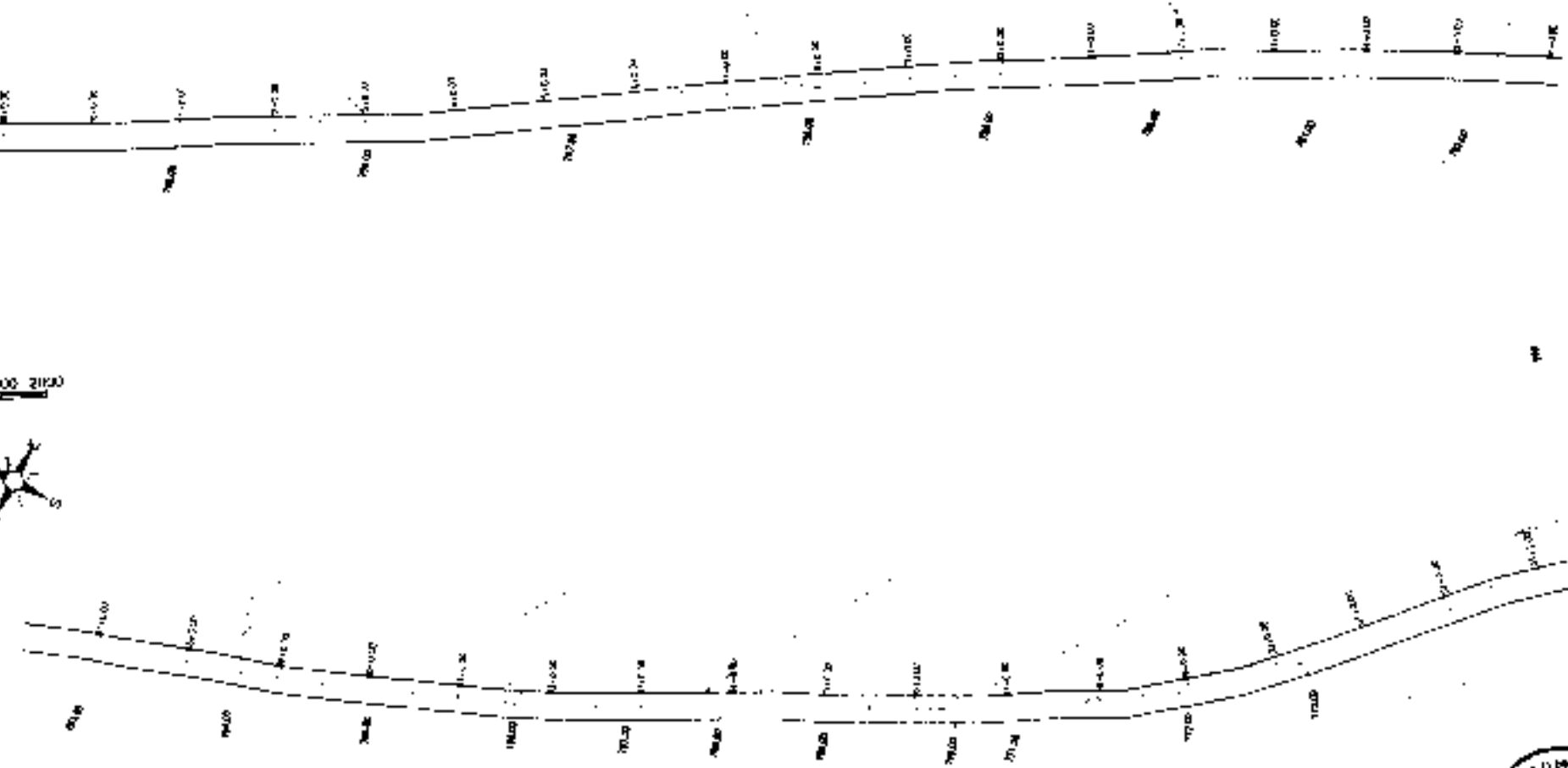
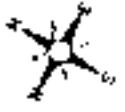
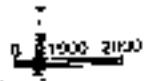
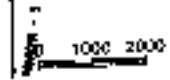

PREFEITURA MUNICIPAL DE QUARACIABA DO NORTE		DATA
RECUPERAÇÃO DE ESTRADAS VICINAIS NO MUNICÍPIO DE QUARACIABA DO NORTE - DE - PT. 0062TU-03		3 / 06
SINALIZAÇÃO VIÁRIA		ESCALA
PROJETO: [illegible]		1:1000
AUTOR: [illegible]		





1000 2000



1000 2000

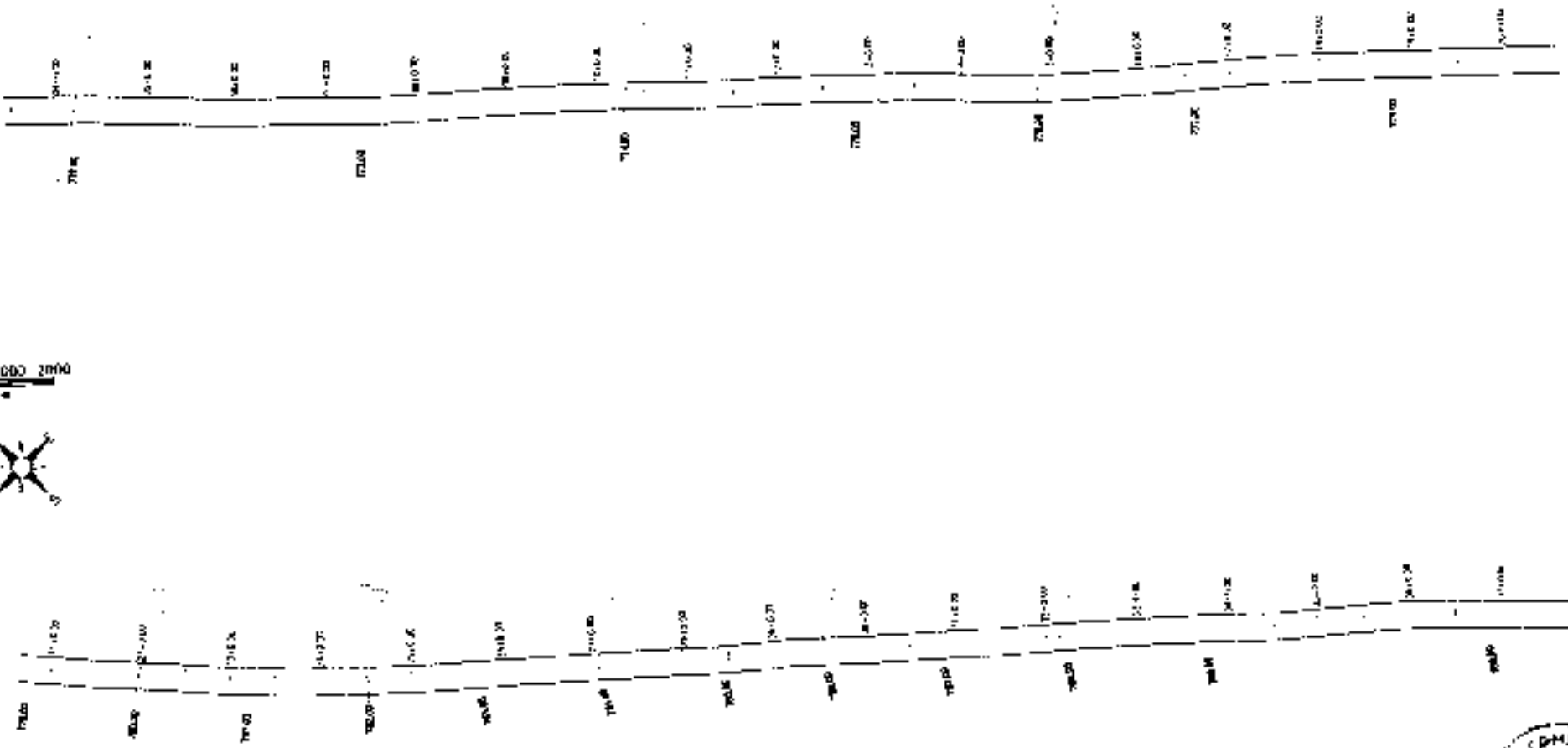

PRÉ-FELTURA MUNICIPAL DE GUARACIABÁ DO NORTE
 RECUPERAÇÃO DE ESTRADAS VICINAIS NO MUNICÍPIO DE GUARACIABÁ DO NORTE-CE - PT 1086270-03
 SINALIZAÇÃO VIÁRIA



4 / 06
 ESCALA
 1:1000

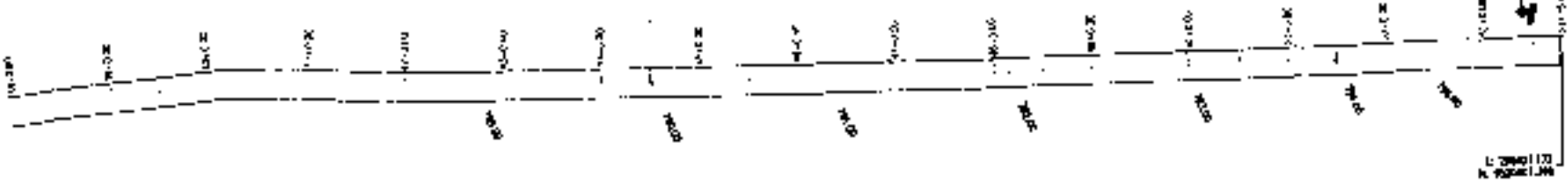
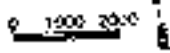

	PREFEITURA MUNICIPAL DE GUARACIABA DO NORTE RECUPERAÇÃO DE ESTRADAS VICINAS NO MUNICÍPIO DE GUARACIABA DO NORTE-CE - PT 1006770-03 SINALIZAÇÃO VIÁRIA		FOLHA 5 / 06
	ESCALA 1:1000	DATA 10/05/2011	

Posicionamento transversal

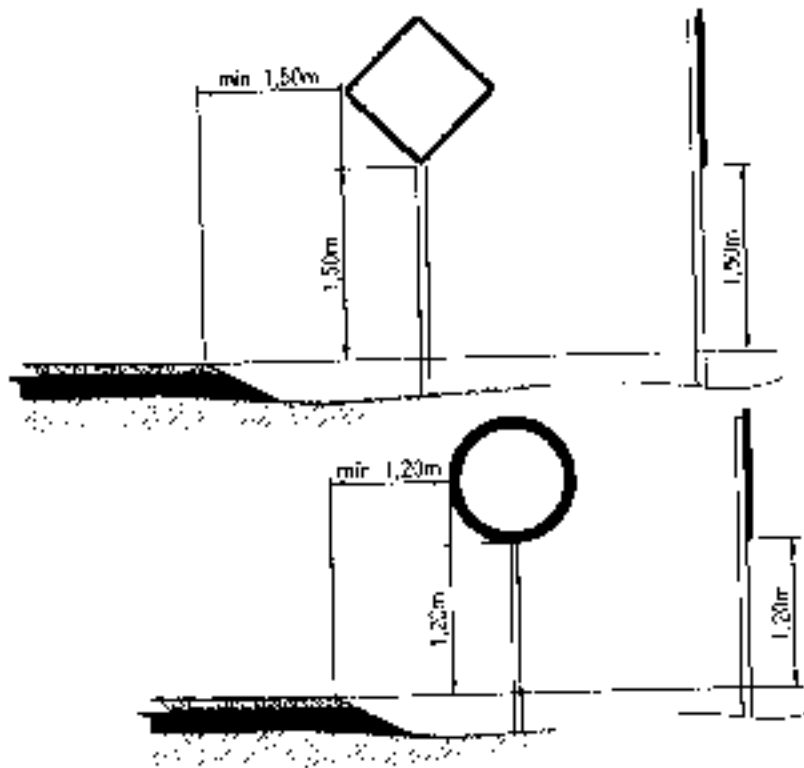

PLACAS DE ADVERTENCIA

PLACAS	QUANTIDADE	VALORES
(m²)	(un)	(un)

PLACAS DE ADVERTENCIA

PLACAS	QUANTIDADE	VALORES
(m²)	(un)	(un)

As Placas de Advertência são de seguintes características:

- Letra - 0,80cm
- Círculo externo - 0,01m
- Círculo interno - 0,02m
- Fundo - Branco
- Letra interna - Preto
- Círculo externo - Branco
- Interno - Preto
- Letra - Preto



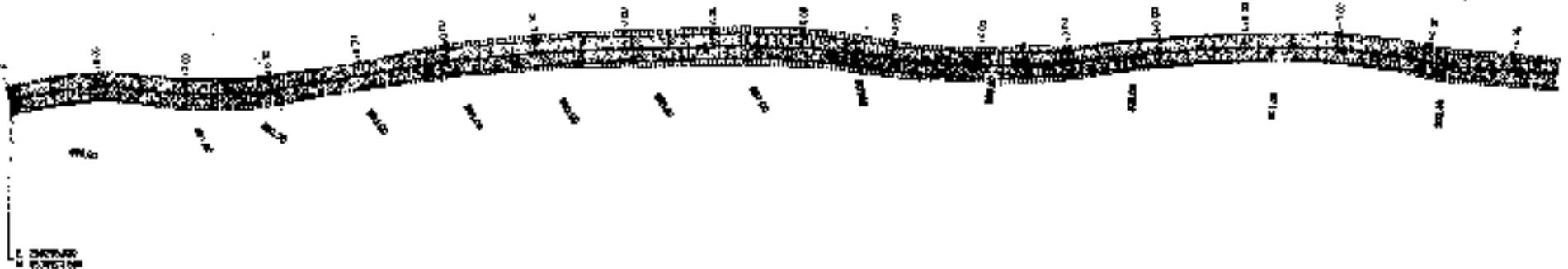

<p>JOTA BARROS PROJETOS</p>	PREFEITURA MUNICIPAL DE GUARACIABA DO NORTE RECUPERAÇÃO DE ESTRADAS VICINAIS NO MUNICÍPIO DE GUARACIABA DO NORTE-CE - R.F. 1006270-03 SINALIZAÇÃO VIÁRIA		PREÇO 6 106
	VALOR UNITÁRIO R\$ 1.000,00		QUANTIDADE 1.100
	VALOR TOTAL R\$ 6.106,00		

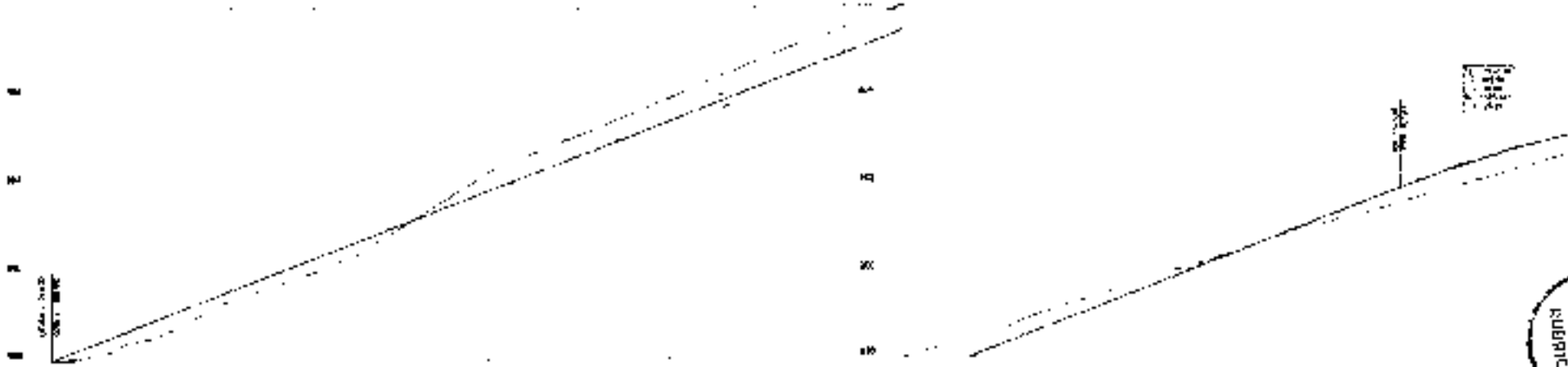

1:1000 30M



1	2	3	4	5	6	7	8	9	10	11	12	13	14	15	16	17	18	19	20
0+00	0+10	0+20	0+30	0+40	0+50	0+60	0+70	0+80	0+90	1+00	1+10	1+20	1+30	1+40	1+50	1+60	1+70	1+80	1+90

-  ASPHALTO CONCRETO
-  CONCRETO
-  CANGA
-  TERRA
-  ENCALDE
-  CORTA
-  DRENAGEM
-  UTILIDADES



PREFEITURA MUNICIPAL DE GUARACIABA DO NORTE
 RECUPERAÇÃO DE ESTRADAS VICINAIS NO MUNICÍPIO DE GUARACIABA DO NORTE-CE - PT 1666270-03
 ESTADUEAMENTO E PERFIL LONGITUDINAL



1 / 11
 ESCALA
 H 1:1000
 V 1:100



0 1000 2000

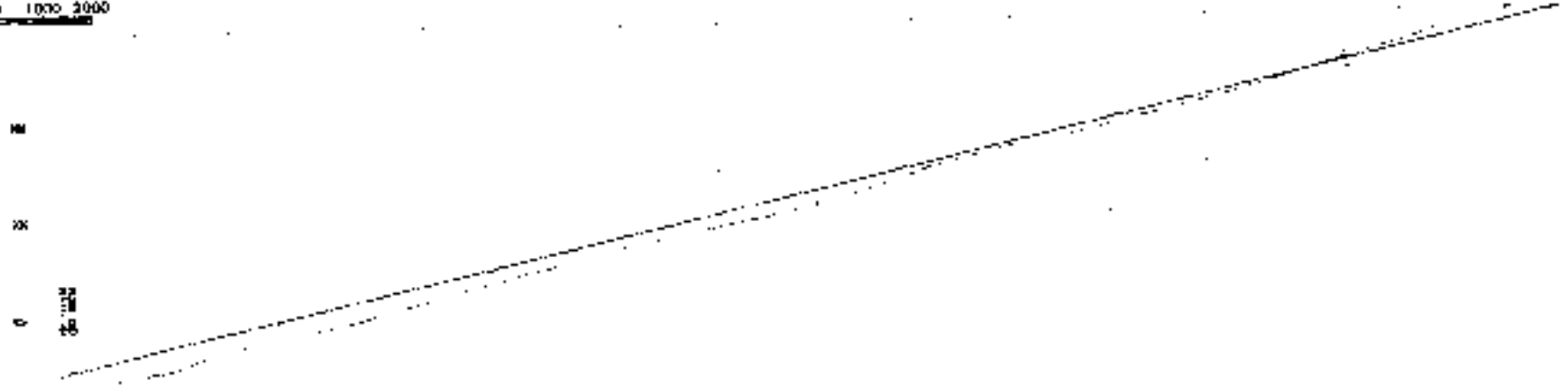

- 1.00
- 1.50
- 2.00
- 2.50
- 3.00
- 3.50
- 4.00
- 4.50
- 5.00
- 5.50
- 6.00
- 6.50
- 7.00
- 7.50
- 8.00
- 8.50
- 9.00
- 9.50
- 10.00
- 10.50
- 11.00



PREFEITURA MUNICIPAL DE GUARACIABA DO NORTE	
RECUPERAÇÃO DE ESTRADAS VICINAIS NO MUNICÍPIO DE GUARACIABA DO NORTE-CE - PT 1188270-13	
ESTAQUEAMENTO E PERFIL LONGITUDINAL	
PROJETO	PROJETO DE ESTUDO DE TRÁFEGO
PROJETO	PROJETO DE DIMENSÃO DE VEÍCULO

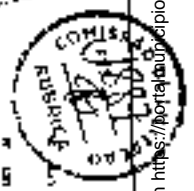

2 / 11
 111 1000
 V 1/100

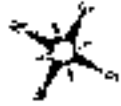

0 1000 2000

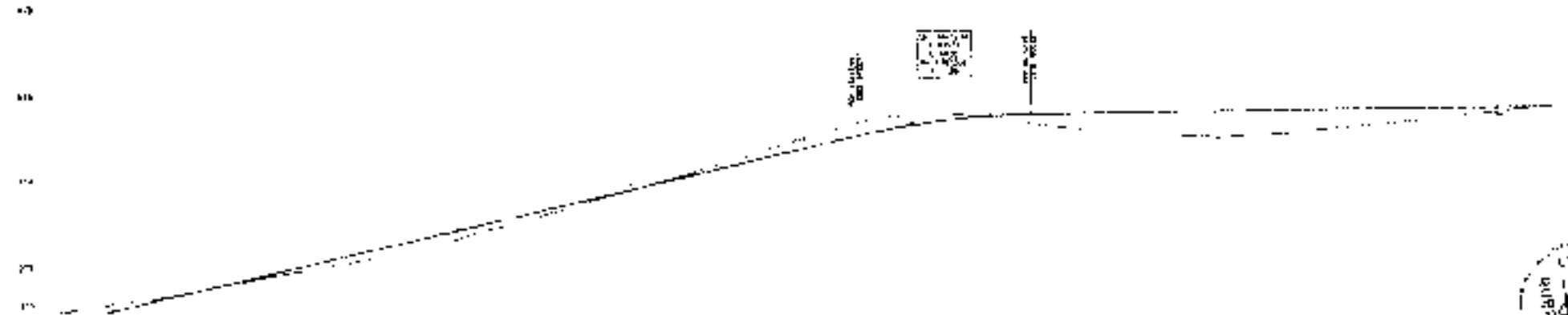

Estacão	1+00	1+10	1+20	1+30	1+40	1+50	1+60	1+70	1+80	1+90	2+00	2+10	2+20	2+30	2+40	2+50	2+60	2+70	2+80	2+90	3+00																																																																						
Alt. (m)	1.00	1.10	1.20	1.30	1.40	1.50	1.60	1.70	1.80	1.90	2.00	2.10	2.20	2.30	2.40	2.50	2.60	2.70	2.80	2.90	3.00	3.10	3.20	3.30	3.40	3.50	3.60	3.70	3.80	3.90	4.00	4.10	4.20	4.30	4.40	4.50	4.60	4.70	4.80	4.90	5.00	5.10	5.20	5.30	5.40	5.50	5.60	5.70	5.80	5.90	6.00	6.10	6.20	6.30	6.40	6.50	6.60	6.70	6.80	6.90	7.00	7.10	7.20	7.30	7.40	7.50	7.60	7.70	7.80	7.90	8.00	8.10	8.20	8.30	8.40	8.50	8.60	8.70	8.80	8.90	9.00	9.10	9.20	9.30	9.40	9.50	9.60	9.70	9.80	9.90	10.00



<p>JOTA BARROS PROJETOS</p>	<p>PREFEITURA MUNICIPAL DE GUARACIABA DO NORTE</p> <p>RECUPERAÇÃO DE ESTRADAS VICINAIS NO MUNICÍPIO DE GUARACIABA DO NORTE-CE - PT 10362/0-03</p> <p>ESTAQUEAMENTO E PERFIL LONGITUDINAL</p>		<p>13/06/2010</p> <p>3 / 11</p>
	<p>PROJETO DE ARQUITETURA E PLANEJAMENTO URBANO</p>	<p>PROJETO DE ARQUITETURA E PLANEJAMENTO URBANO</p>	<p>PROJETO DE ARQUITETURA E PLANEJAMENTO URBANO</p>
	<p>PROJETO DE ARQUITETURA E PLANEJAMENTO URBANO</p>	<p>PROJETO DE ARQUITETURA E PLANEJAMENTO URBANO</p>	<p>PROJETO DE ARQUITETURA E PLANEJAMENTO URBANO</p>



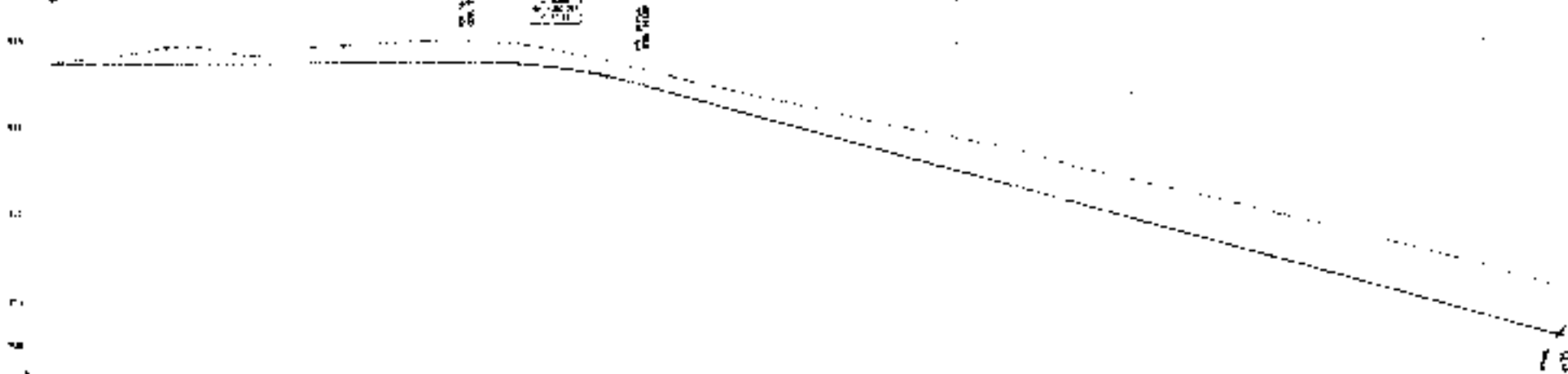
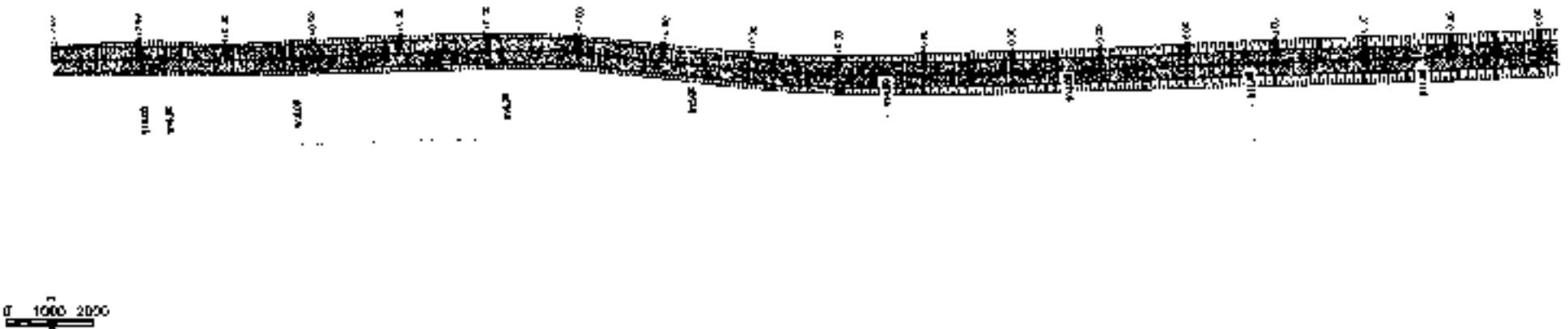

11800	11820	11840	11860	11880	11900	11920	11940	11960	11980	12000	12020	12040	12060	12080	12100	12120	12140	12160	12180	12200	12220	12240	12260	12280	12300	12320	12340	12360	12380	12400	12420	12440	12460	12480	12500
-------	-------	-------	-------	-------	-------	-------	-------	-------	-------	-------	-------	-------	-------	-------	-------	-------	-------	-------	-------	-------	-------	-------	-------	-------	-------	-------	-------	-------	-------	-------	-------	-------	-------	-------	-------

11800	11820	ESTRADA	11840	11860	11880	11900	11920

<p>JOTA BARROS PROJETOS</p>	PREFEITURA MUNICIPAL DE GUARACIABA DO NORTE RECUPERAÇÃO DE ESTRADAS VICINAIS NO MUNICÍPIO DE GUARACIABA DO NORTE-CE - PT 1086270-03		4 / 11 ESCALA H 1 1000 V 1/100
	ESTAQUEAMENTO E PERFIL LONGITUDINAL		
	PROJEÇÃO:	DATA:	



0 1000 2000

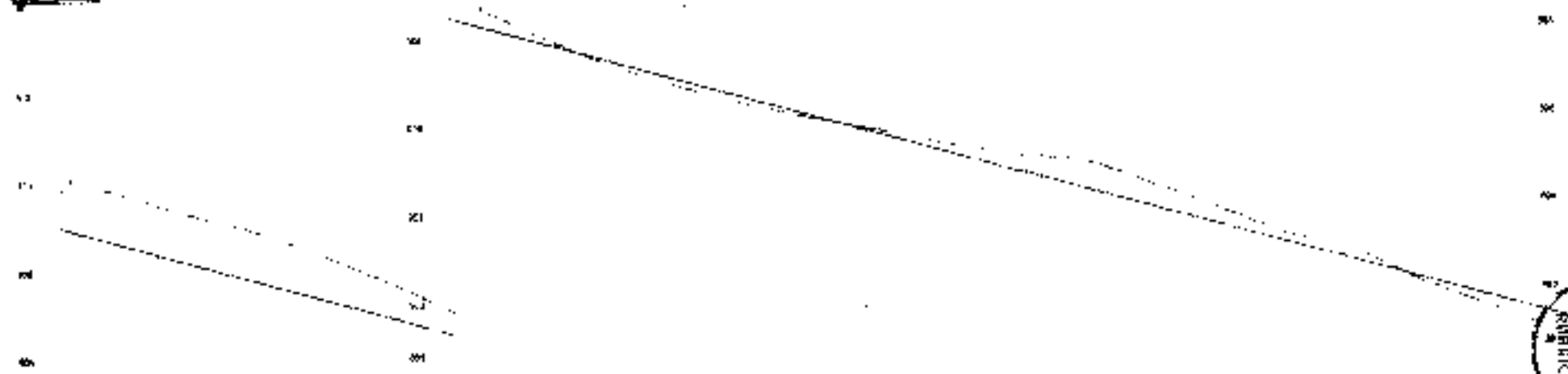

10+00	10+20	10+40	10+60	10+80	11+00	11+20	11+40	11+60	11+80	12+00	12+20	12+40	12+60	12+80	13+00	13+20	13+40	13+60	13+80	14+00
-------	-------	-------	-------	-------	-------	-------	-------	-------	-------	-------	-------	-------	-------	-------	-------	-------	-------	-------	-------	-------



- LIMPEZA
- PROTEÇÃO
- PINTURA
- MANTENÇÃO
- TUBO DE
- DRENAGEM
- LANTERNA
- CANTO DE ENCAMARTEAMENTO



PREFEITURA MUNICIPAL DE GUARACIABA DO NORTE	
RECLAMAÇÃO DE ESTRADAS VICINAIS NO MUNICÍPIO DE GUARACIABA DO NORTE-CE - P.º 006270-00	
ESTAQUEAMENTO E PERFIL LONGITUDINAL	
PROJETO DE	PROJ. CIVIL - ENGENHARIA DE OBRAS DE INFRAESTRUTURA
REALIZADO POR	PROJ. CIVIL - ENGENHARIA DE OBRAS DE INFRAESTRUTURA

TAB. Nº	5 / 11
ESCALA	H 1:1000
V	1:100

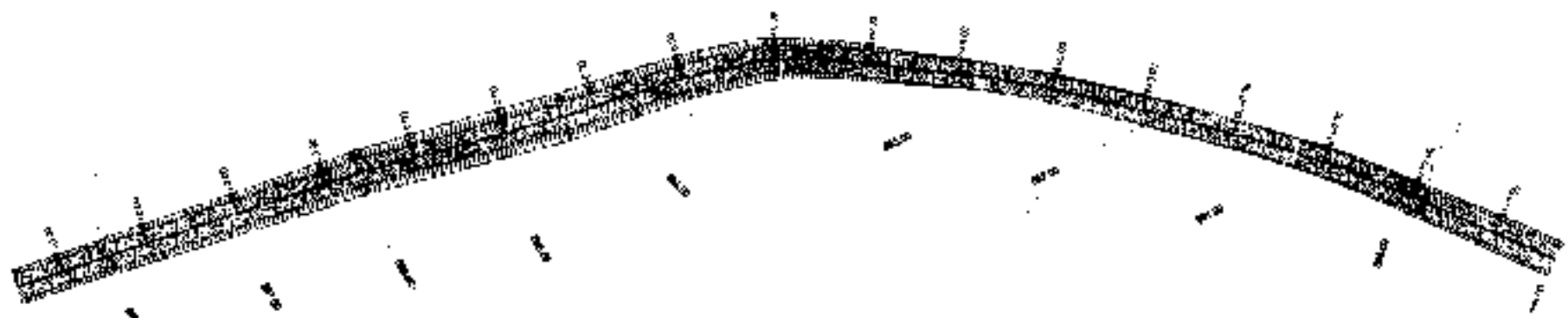
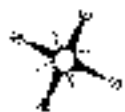

0 1000 2000

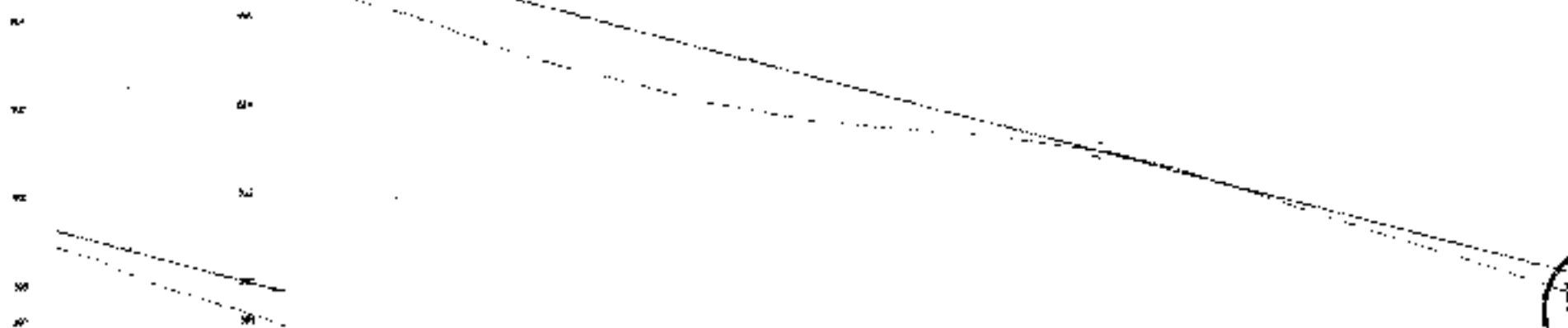

1	2	3	4	5	6	7	8	9	10	11	12	13	14	15	16	17	18	19	20	21	22	23	24	25	26	27	28	29	30	31	32	33	34	35	36	37	38	39	40	41	42	43	44	45	46	47	48	49	50	51	52	53	54	55	56	57	58	59	60	61	62	63	64	65	66	67	68	69	70	71	72	73	74	75	76	77	78	79	80	81	82	83	84	85	86	87	88	89	90	91	92	93	94	95	96	97	98	99	100
---	---	---	---	---	---	---	---	---	----	----	----	----	----	----	----	----	----	----	----	----	----	----	----	----	----	----	----	----	----	----	----	----	----	----	----	----	----	----	----	----	----	----	----	----	----	----	----	----	----	----	----	----	----	----	----	----	----	----	----	----	----	----	----	----	----	----	----	----	----	----	----	----	----	----	----	----	----	----	----	----	----	----	----	----	----	----	----	----	----	----	----	----	----	----	----	----	----	----	-----

ASFA	CONC	GR	TER	PAV	ARE	DR	UT



PREFEITURA MUNICIPAL DE GUARACIABA DO NORTE
 RECUPERAÇÃO DE ESTRADAS VICINAIS NO MUNICÍPIO DE GUARACIABA DO NORTE-CE - Nº 1065270-03
 ESTAGUEAMENTO E PERFA. LONGITUDINAL

PROJETO	ELABORADO POR	JOTA BARRAS PEREIRA
PROJETO	REVISADO POR	JOTA BARRAS PEREIRA



TABELA
 6 / 11
 ESCALA
 H 1:1000
 V 1:100



1000 1000

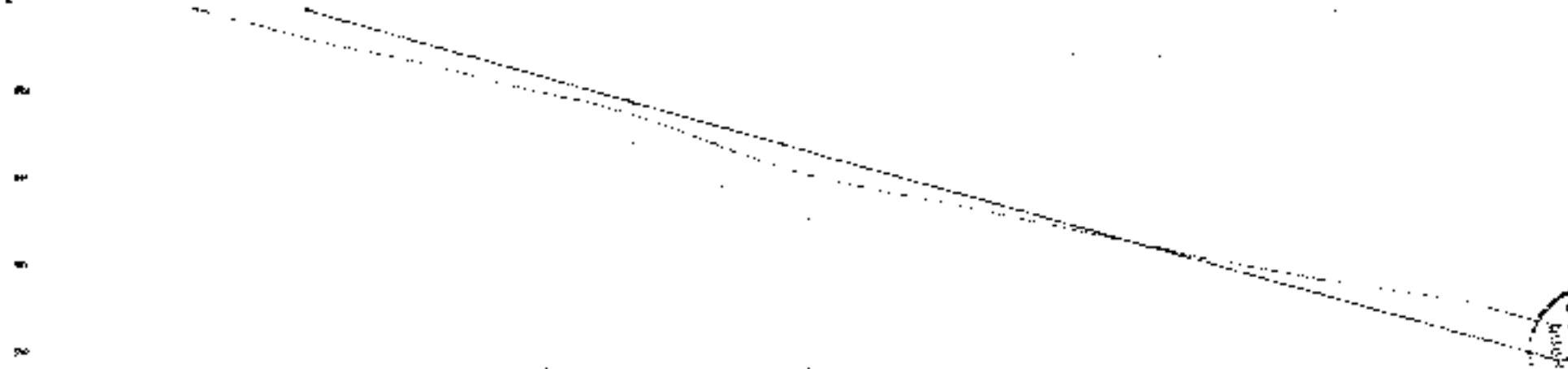

0+00	0+10	0+20	0+30	0+40	0+50	0+60	0+70	0+80	0+90	1+00	1+10	1+20	1+30	1+40	1+50	1+60	1+70	1+80	1+90	2+00
100	100	100	100	100	100	100	100	100	100	100	100	100	100	100	100	100	100	100	100	100
100	100	100	100	100	100	100	100	100	100	100	100	100	100	100	100	100	100	100	100	100

ASPL. CONV.	CONCRETO	GRANULADO	TERREIRO	AREIA	ÁGUA	VAZIOS	VEGETAÇÃO



PREFEITURA MUNICIPAL DE GUARACIABA DO NORTE

RECUPERAÇÃO DE ESTRADAS VICINAIS NO MUNICÍPIO DE GUARACIABA DO NORTE-CE - IPT 1086270-00

ESTAQUEAMENTO E PERFIL LONGITUDINAL

PROJETO: []

FECHA: []

LOCAL: []

7 / 11

ESCALA: H 1:1000 V 1:100

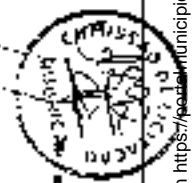

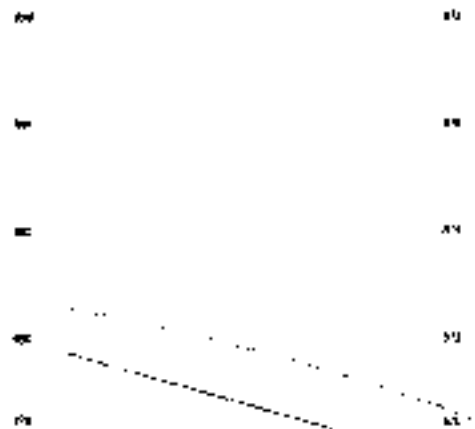

ESTACÃO	PROFUNDIDADE	PROFUNDIDADE	PROFUNDIDADE	PROFUNDIDADE	PROFUNDIDADE	PROFUNDIDADE	PROFUNDIDADE	PROFUNDIDADE	PROFUNDIDADE	PROFUNDIDADE	PROFUNDIDADE	PROFUNDIDADE	PROFUNDIDADE	PROFUNDIDADE	PROFUNDIDADE	PROFUNDIDADE	PROFUNDIDADE	PROFUNDIDADE
0+00	1.00	1.00	1.00	1.00	1.00	1.00	1.00	1.00	1.00	1.00	1.00	1.00	1.00	1.00	1.00	1.00	1.00	1.00
0+25	1.00	1.00	1.00	1.00	1.00	1.00	1.00	1.00	1.00	1.00	1.00	1.00	1.00	1.00	1.00	1.00	1.00	1.00
0+50	1.00	1.00	1.00	1.00	1.00	1.00	1.00	1.00	1.00	1.00	1.00	1.00	1.00	1.00	1.00	1.00	1.00	1.00
0+75	1.00	1.00	1.00	1.00	1.00	1.00	1.00	1.00	1.00	1.00	1.00	1.00	1.00	1.00	1.00	1.00	1.00	1.00
1+00	1.00	1.00	1.00	1.00	1.00	1.00	1.00	1.00	1.00	1.00	1.00	1.00	1.00	1.00	1.00	1.00	1.00	1.00
1+25	1.00	1.00	1.00	1.00	1.00	1.00	1.00	1.00	1.00	1.00	1.00	1.00	1.00	1.00	1.00	1.00	1.00	1.00
1+50	1.00	1.00	1.00	1.00	1.00	1.00	1.00	1.00	1.00	1.00	1.00	1.00	1.00	1.00	1.00	1.00	1.00	1.00
1+75	1.00	1.00	1.00	1.00	1.00	1.00	1.00	1.00	1.00	1.00	1.00	1.00	1.00	1.00	1.00	1.00	1.00	1.00
2+00	1.00	1.00	1.00	1.00	1.00	1.00	1.00	1.00	1.00	1.00	1.00	1.00	1.00	1.00	1.00	1.00	1.00	1.00
2+25	1.00	1.00	1.00	1.00	1.00	1.00	1.00	1.00	1.00	1.00	1.00	1.00	1.00	1.00	1.00	1.00	1.00	1.00
2+50	1.00	1.00	1.00	1.00	1.00	1.00	1.00	1.00	1.00	1.00	1.00	1.00	1.00	1.00	1.00	1.00	1.00	1.00
2+75	1.00	1.00	1.00	1.00	1.00	1.00	1.00	1.00	1.00	1.00	1.00	1.00	1.00	1.00	1.00	1.00	1.00	1.00
3+00	1.00	1.00	1.00	1.00	1.00	1.00	1.00	1.00	1.00	1.00	1.00	1.00	1.00	1.00	1.00	1.00	1.00	1.00

	PREFEITURA MUNICIPAL DE GUARACIÁBA DO NORTE RECUPERAÇÃO DE ESTRADAS VICINAIS NO MUNICÍPIO DE GUARACIÁBA DO NORTE-CE - PT 1086270-03		8 / 11 H. 1.5000 V. 17100
	ESTAGUEAMENTO E PERFIL LONGITUDINAL		
PROJ. CIVIL	PROJ. CIVIL E MEC. CIVIL		DATA
PROJ. ELETR.	PROJ. ELETR.		LOCAL





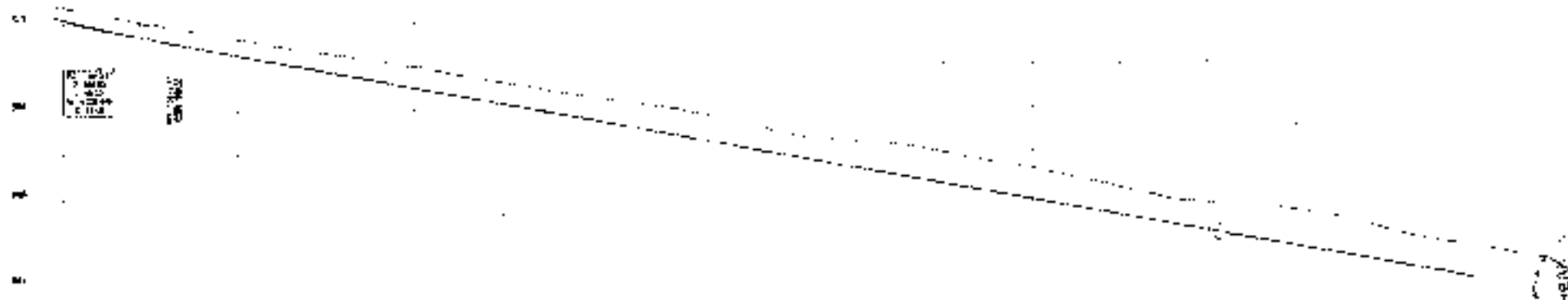

3 1000 2000

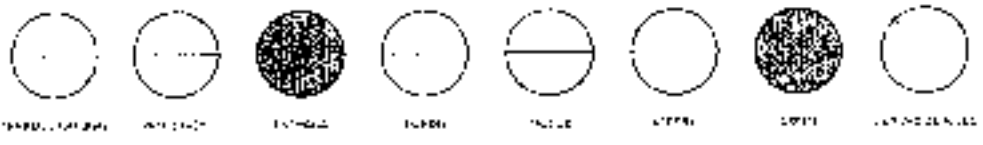

1	2	3	4	5	6	7	8	9	10	11	12	13	14	15	16	17	18	19	20
100	100	100	100	100	100	100	100	100	100	100	100	100	100	100	100	100	100	100	100
100	100	100	100	100	100	100	100	100	100	100	100	100	100	100	100	100	100	100	100
100	100	100	100	100	100	100	100	100	100	100	100	100	100	100	100	100	100	100	100



	PREFEITURA MUNICIPAL DE GUARACIABA DO NORTE		FOLHA Nº
	RECUPERAÇÃO DE ESTRADAS VICINAIS NO MUNICÍPIO DE GUARACIABA DO NORTE-CE - PT 1086210-03		9 / 11
	ESTAQUEAMENTO E PERFIL LONGITUDINAL		ESCALA H 1:1000 V 1:100

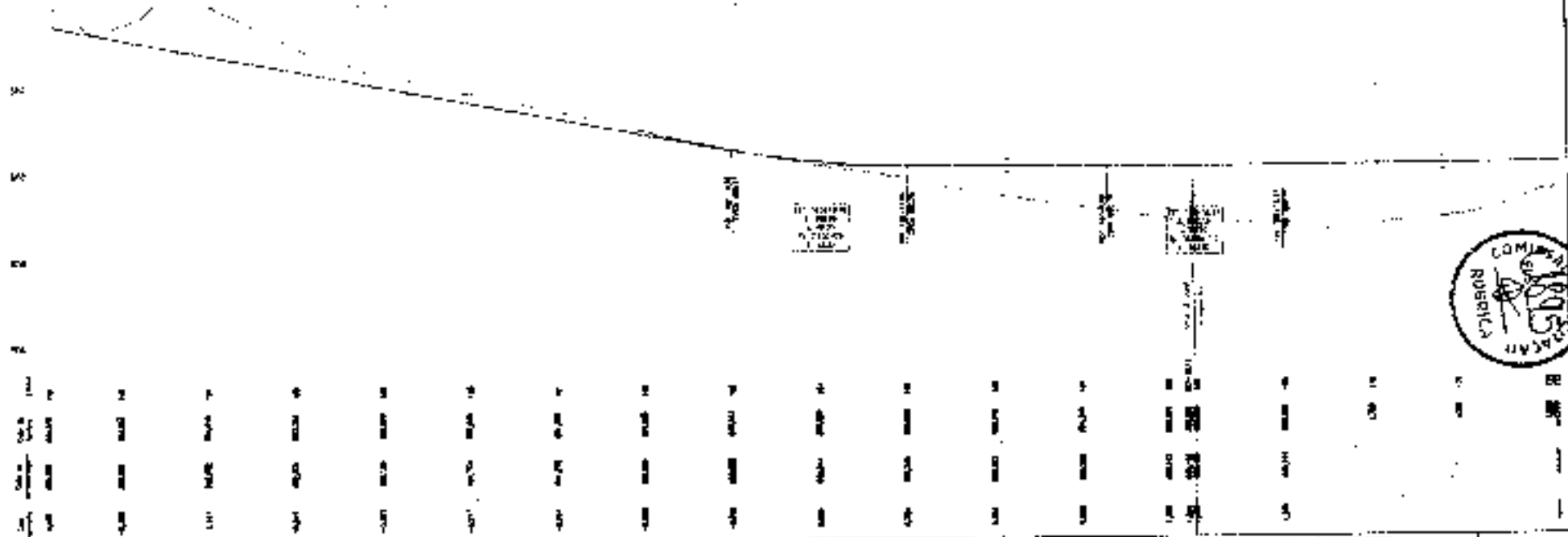
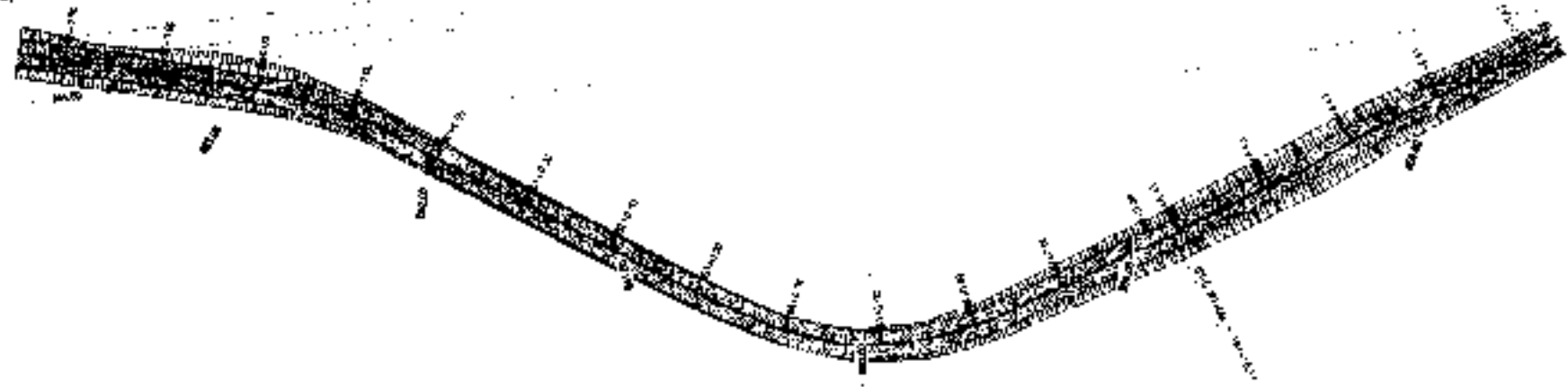

 NOTA BRASIL PROJETEIS	PREFEITURA MUNICIPAL DE GUARACIABA DO NORTE RECUPERAÇÃO DE ESTRADAS VICINAIS NO MUNICÍPIO DE GUARACIABA DO NORTE-CE - PT 188528-03		DATA 10 / 11
	ESTAQUEAMENTO E PERFIL LONGITUDINAL		
PROJETO	LOCAL	ESCALA	NÚMERO



0 1000 2000



0m - 0

1

2

3

4

5

6

7

8



PREFEITURA MUNICIPAL DE GUARACABA DO NORTE		DATA: 11/11
RECUPERAÇÃO DE ESTRADAS VICINAIS NO MUNICÍPIO DE GUARACABA DO NORTE-CE Nº 1086270-03		ESCALA: H 1:1000 V 1:100
ESTAGUAMENTO E PERFIL LONGITUDINAL		
PROJETO: []	LOCAL: []	
FEITO POR: []	APROVADO: []	

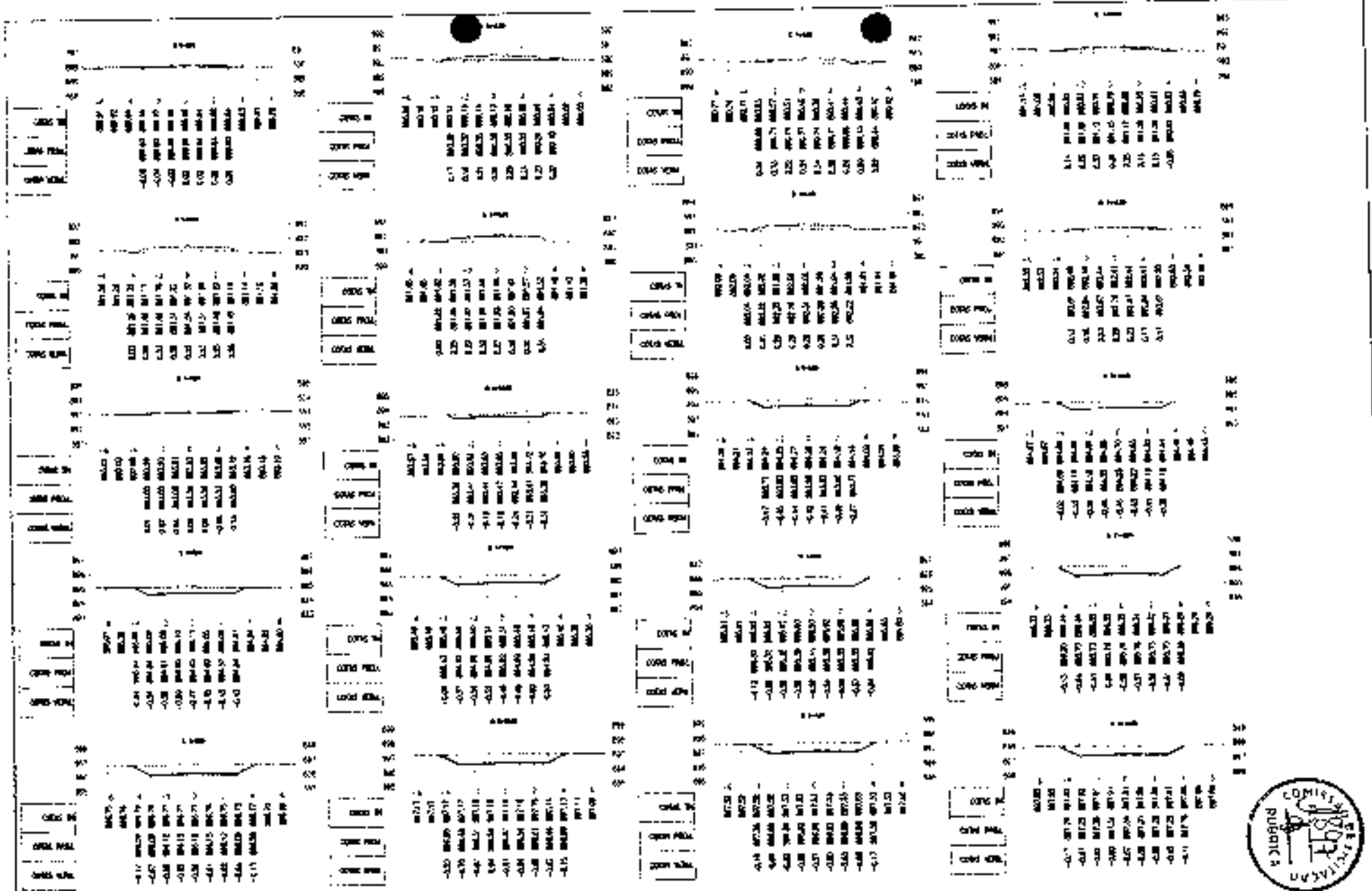

ATERRO
 CORTES



PREFEITURA MUNICIPAL DE GUARACIABA DO NORTE:
RECUPERAÇÃO DE ESTRADAS VICINAIS NO MUNICÍPIO DE GUARACIABA DO NORTE-CE - P1 1086270-03
SEÇÕES TRANSVERSAIS
 ESCALA: 1:250
 DATA: 10/05/2017
 LOCAL: MUNICÍPIO DE GUARACIABA DO NORTE, ESTADO DO CEARÁ

FOLHA Nº
1 / 20
 DATA
 1/250



LEGENDA

-  ALERHO
-  CORTE

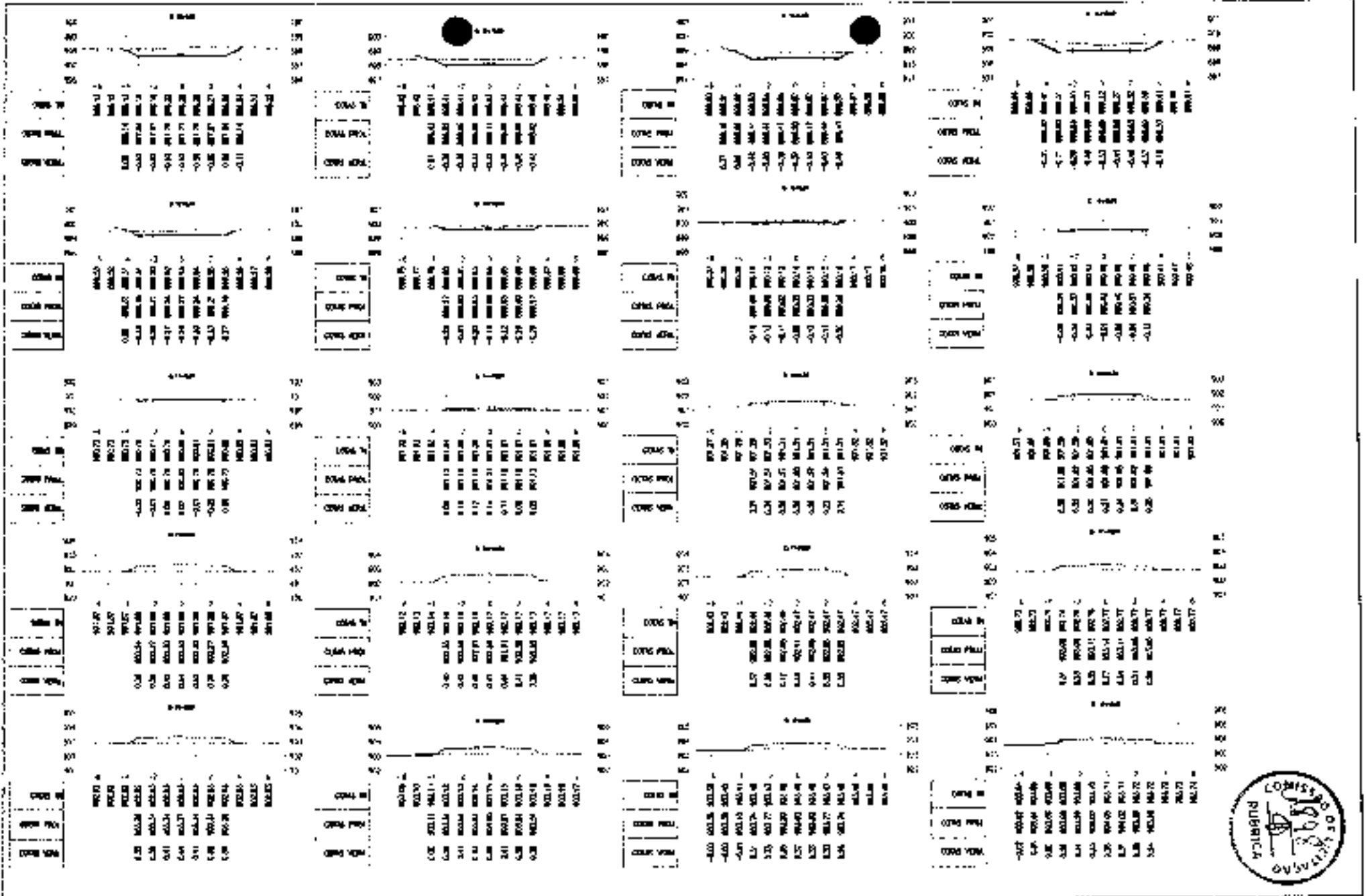



	PREFEITURA MUNICIPAL DE GUARACIABA DO NORTE RECUPERAÇÃO DE ESTRADAS VICINAIS NO MUNICÍPIO DE GUARACIABA DO NORTE-CE - PT 10862701-00		Folha nº 2 / 20
	SEÇÕES TRANSVERSAIS		Escala 1:250
	Data:	10/05/2011	Projeto:

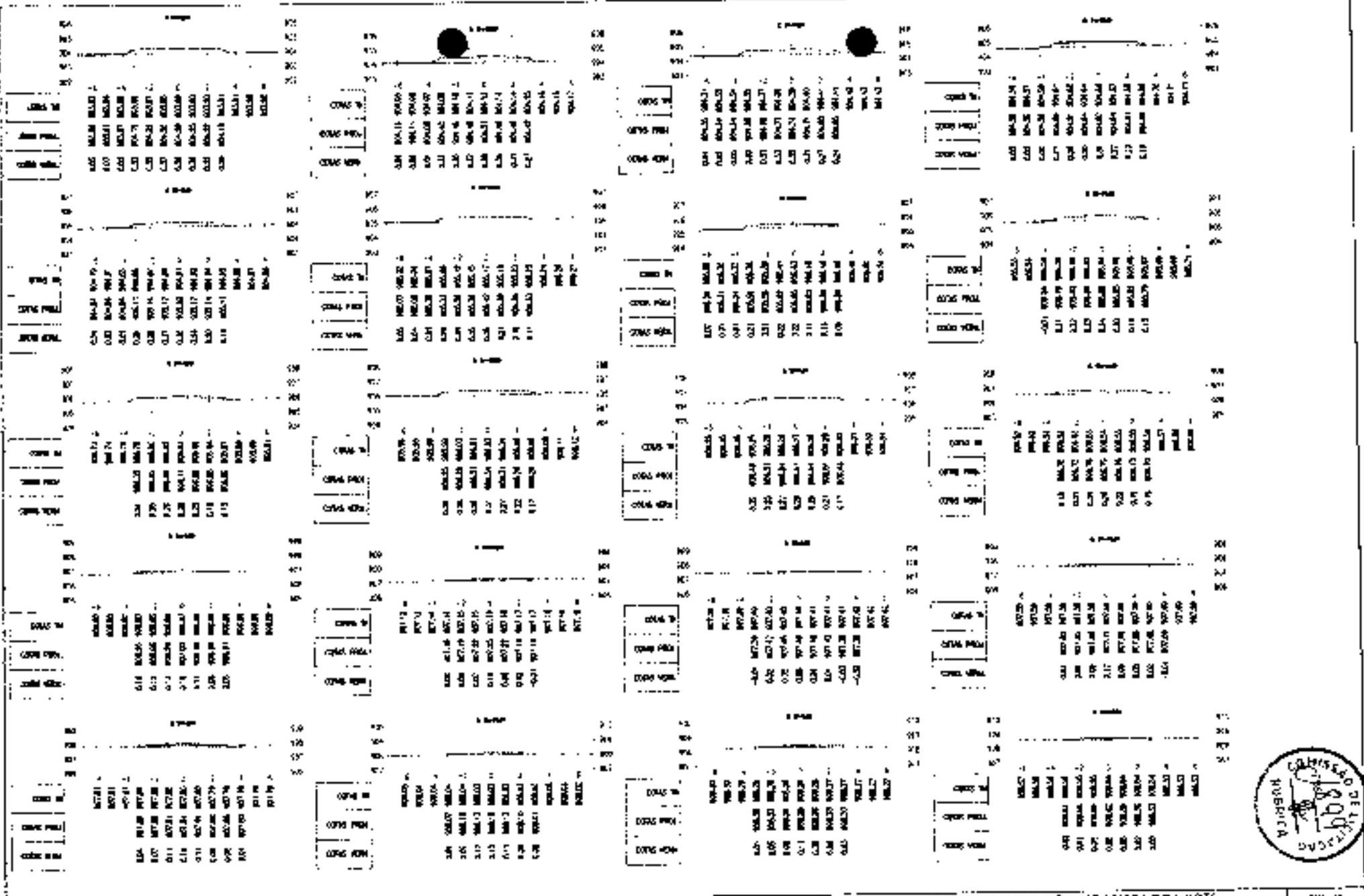

LEGENDA

-  ATERRÓ
-  CORTE



	PREFEITURA MUNICIPAL DE GUARACIABA DO NORTE. RECUPERAÇÃO DE ESTRADAS VICINAIS NO MUNICÍPIO DE GUARACIABA DO NORTE-CE - PI 1088270-03		Nº 3 / 20
	SEÇÕES TRANSVERSAIS		
	ESCALA: 1:100	DATA: 10/05/2011	PROJETO: RECONSTRUÇÃO DE ESTRADAS VICINAIS



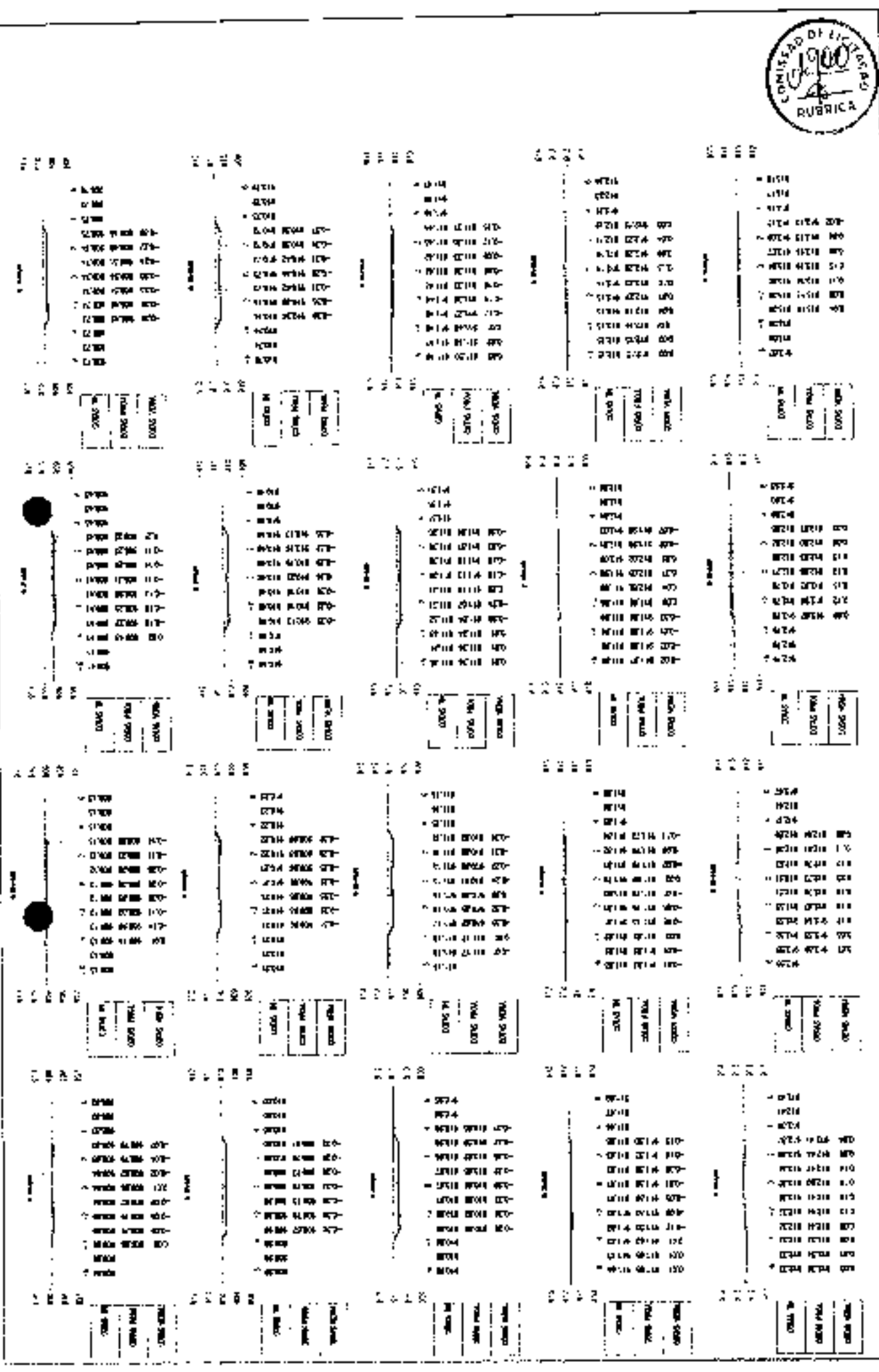

PREFEITURA MUNICIPAL DE GUARACABA DO NORTE
 RECUPERAÇÃO DE ESTRADAS VICINAIS NO MUNICÍPIO DE GUARACABA
 301 NORTE-CE - PI 4888270-001

SEÇÕES TRANSVERSAIS

Nº 100
 1/200



LEGENDA

ATERRO

CORTE

LEGENDA

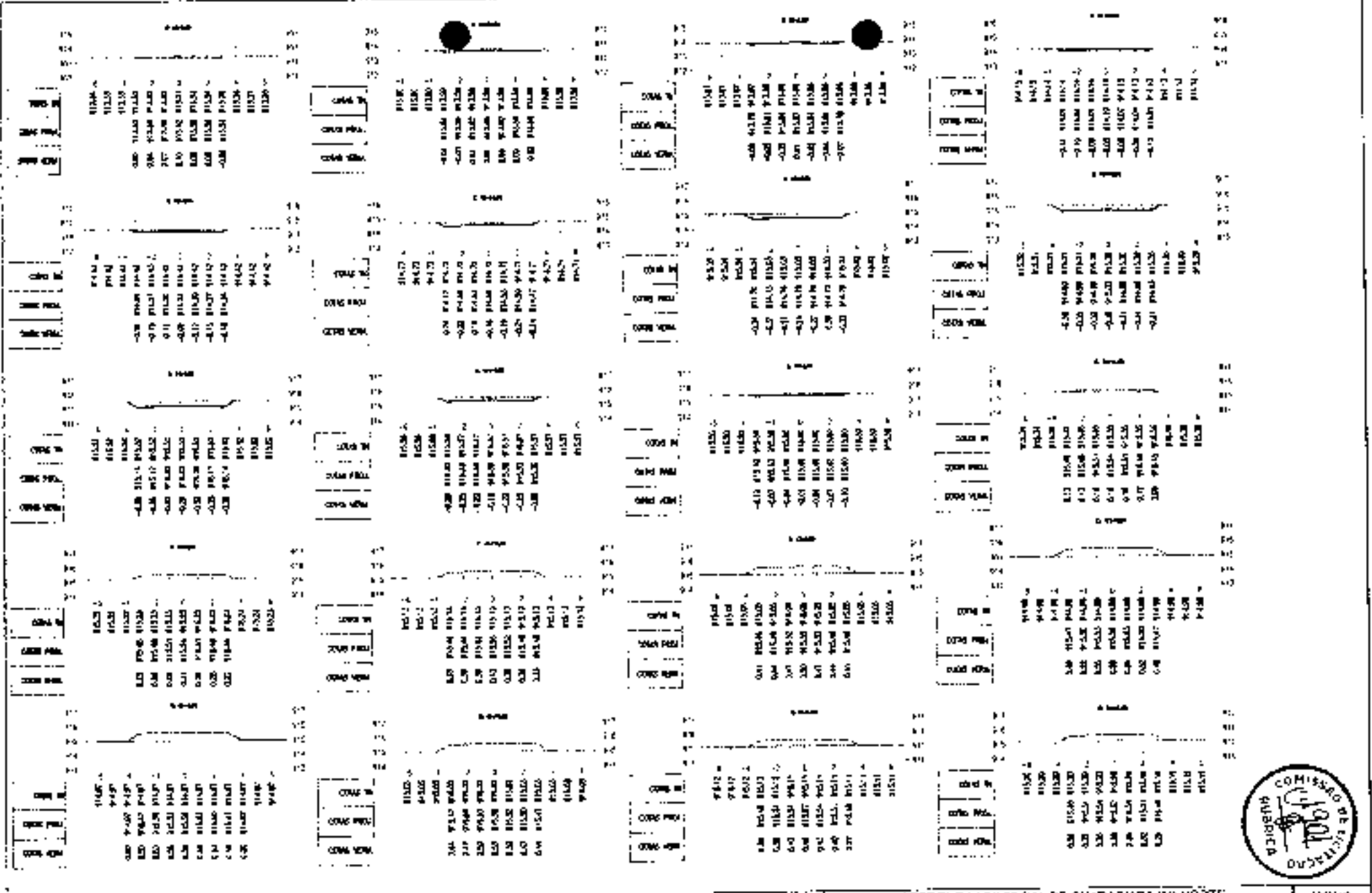

PREFEITURA MUNICIPAL DE GUARACIABA DO NORTE
 RECUPERAÇÃO DE ESTRADAS VICINAS AO MUNICÍPIO DE GUARACIABA
 DO NORTE-CE - PT 10R5270-00
 SEÇÕES TRANSVERSAIS

5 / 20
 1/250



LEGENDA

- ATERRO
- CURVA

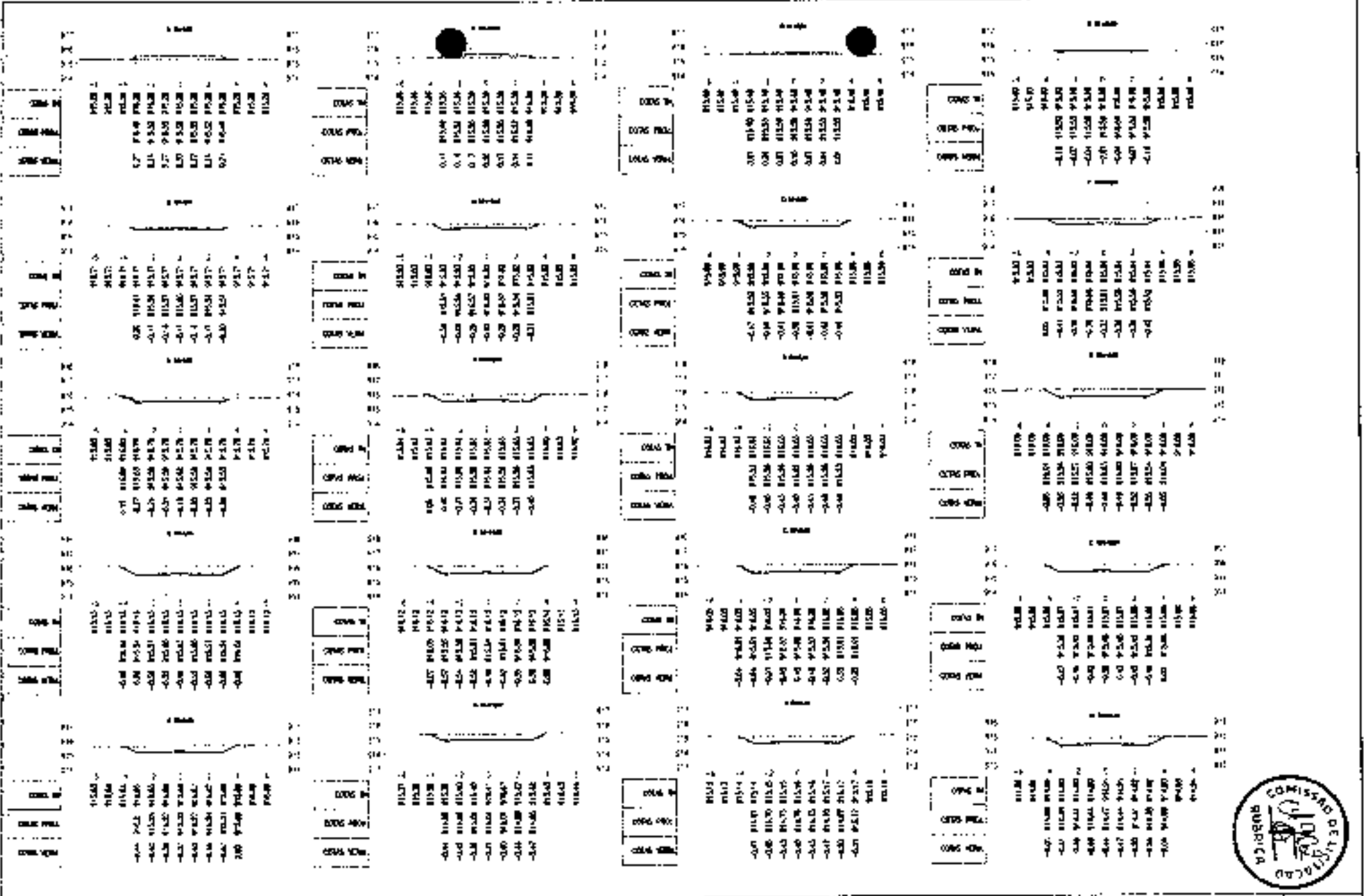

	PREFEITURA MUNICIPAL DE GUARACIARA DO NORTE RECUPERAÇÃO DE ESTRADAS VICINAIS NO MUNICÍPIO DE GUARACIARA DO NORTE-CE - PT 1086370-13		Nº 6 / 20 1/250
	SEÇÕES TRANSVERSAIS		
	ESCALA: 1:200 DATA: 10/05/2010		





7 / 20

PREFEITURA MUNICIPAL DE GUARACUBA DO NORTE
 RECUPERAÇÃO DE ESTRADAS VICINAIS NO MUNICÍPIO DE GUARACUBA
 DO NORTE-CE, PT. I (RETIJITO)
 SEÇÕES TRANSVERSAIS



EMPRESA: JOÃO BARROS PAZ & FILHO
 ENDEREÇO: RUA...

DATA: ...

LOCAL: ...

PROJETO: ...

ESCALA: ...

PROJ. CIVIL: ...

PROJ. MEC. E ELÉTRIC.: ...

PROJ. PAVIMENT.: ...

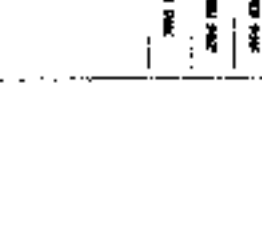
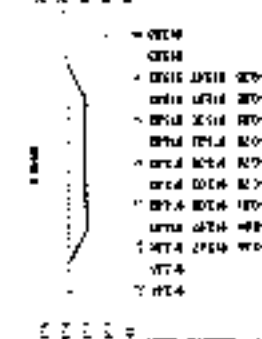
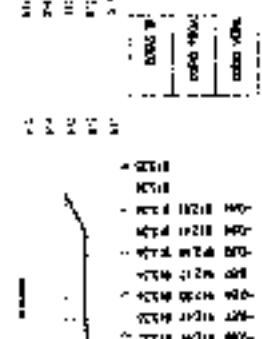
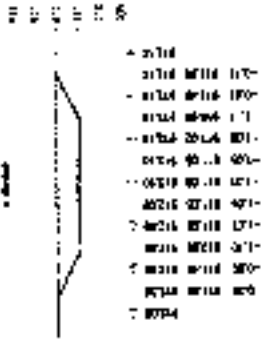
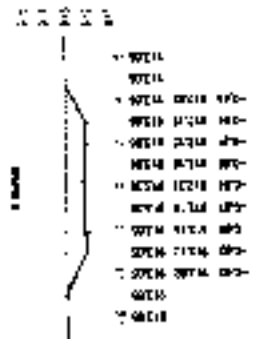
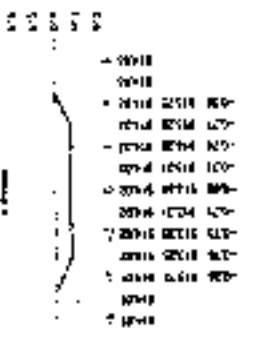

LEGENDA

-  ATERRO
-  CORTE



PREFEITURA MUNICIPAL DE GUARACAMA DO NORTE
 RECUPERAÇÃO DE ESTRADAS VICINAIS NO MUNICÍPIO DE GUARACAMA DO NORTE-CE - PT. 10002/0-03
 SEÇÕES TRANSVERSAIS

10002/0-03
 8 / 20
 1:250

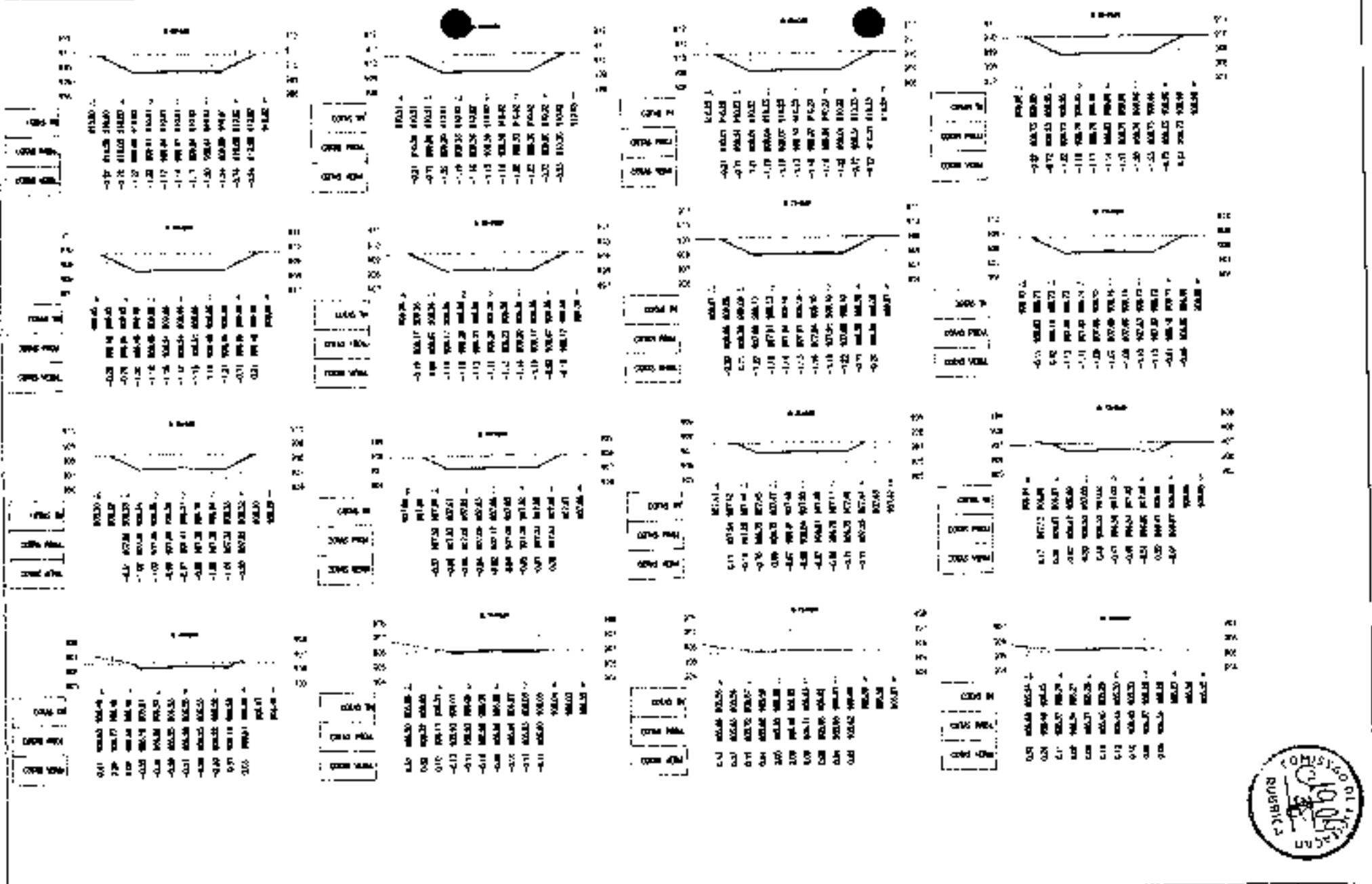

EGFMDA

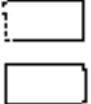

ACPRD

CURTE

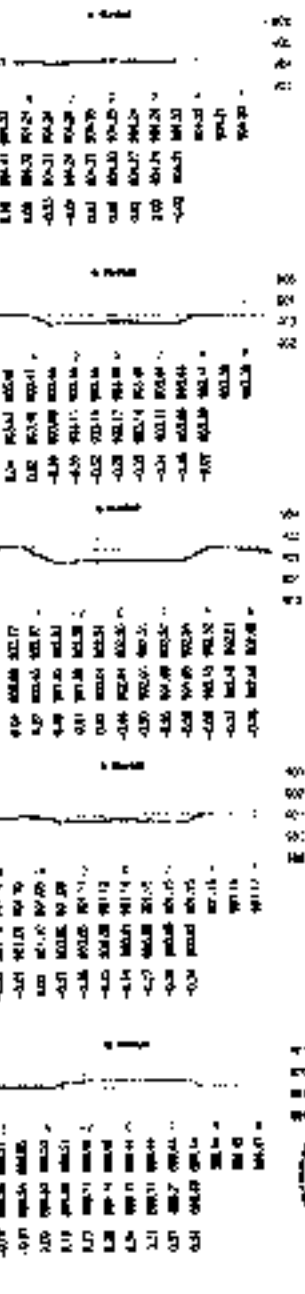
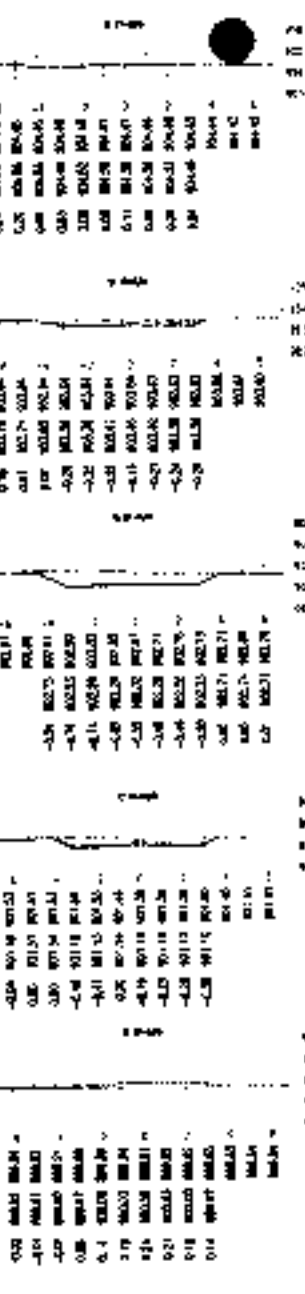
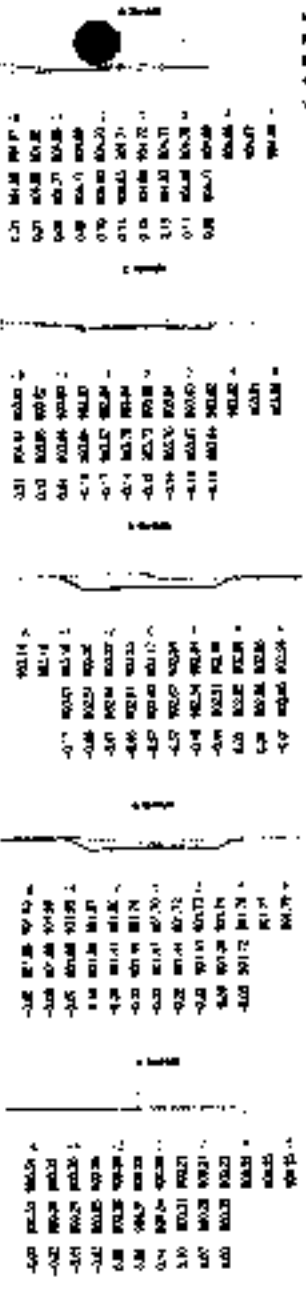
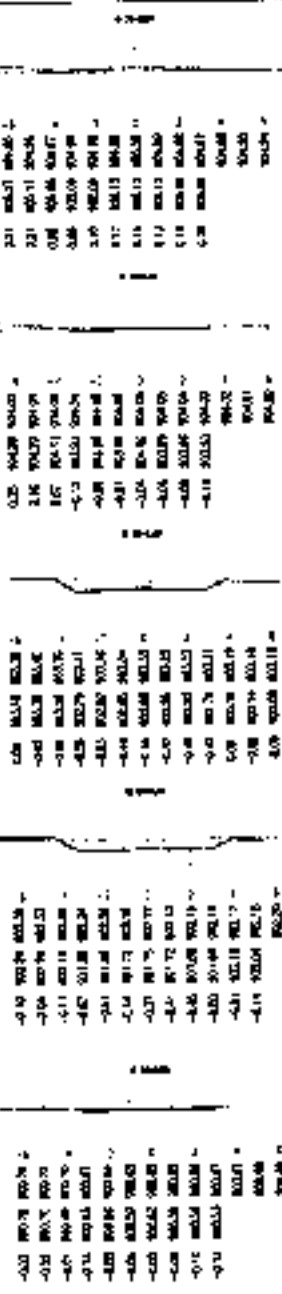

PRÉCATORIA MUNICIPAL DE GUARACIARA DO NORTE.
 RECUPERAÇÃO DE ESTRADAS VICINAIS NO MUNICÍPIO DE GUARACIARA DO NORTE - PE - PT 1006270-03
 SEÇÕES TRANSVERSAIS

1/20
 1/293

LEGENDA

-  ATERRO
-  CORTE



PREFEITURA MUNICIPAL DE GUARACIABA DO NORTE.
 RECUPERAÇÃO DE ESTRADAS VICINAIS NO MUNICÍPIO DE GUARACIABA DO NORTE-CE - PI 1086270-03
 SEÇÕES TRANSVERSAIS

10 / 20
 1:250

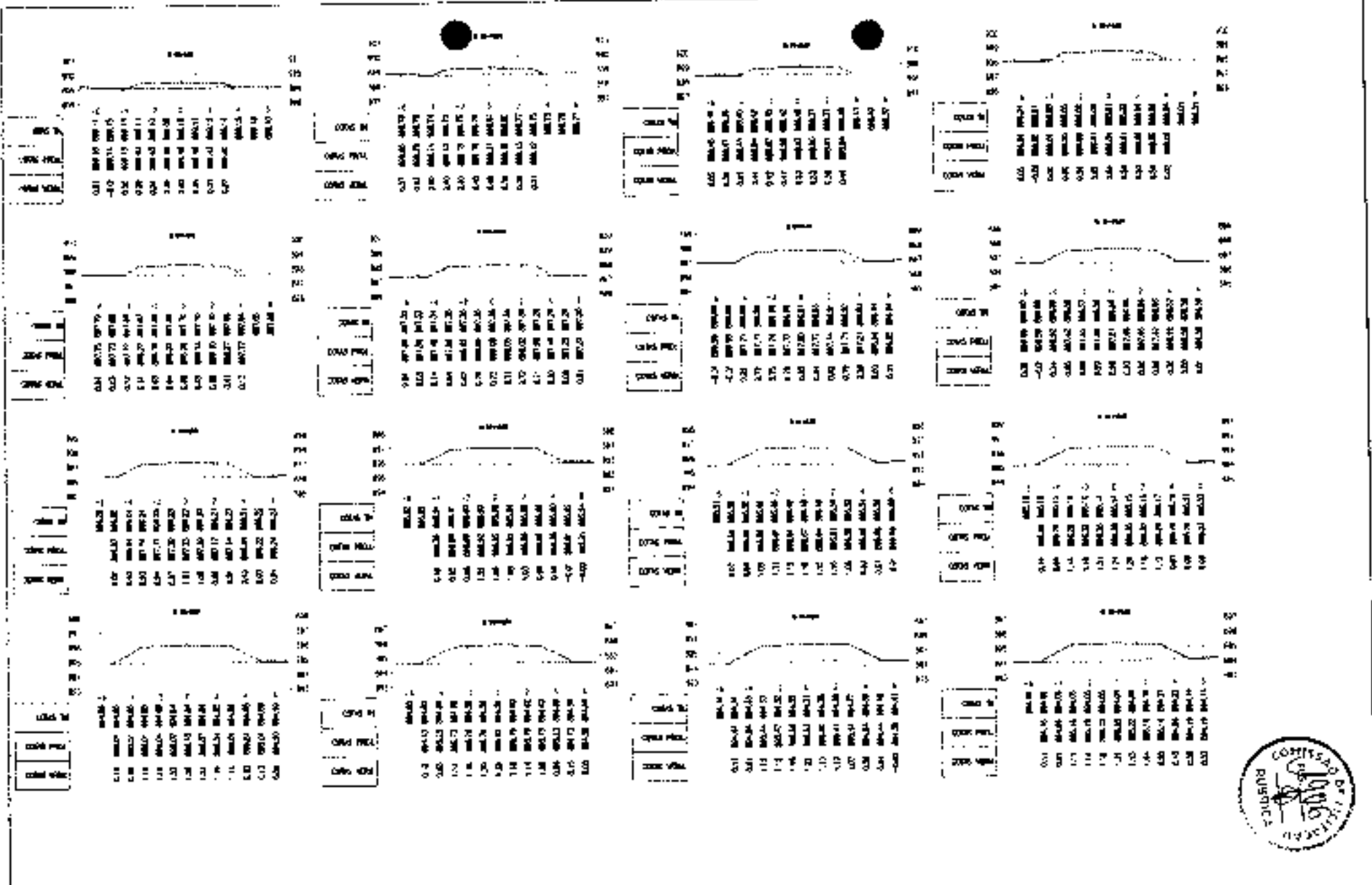

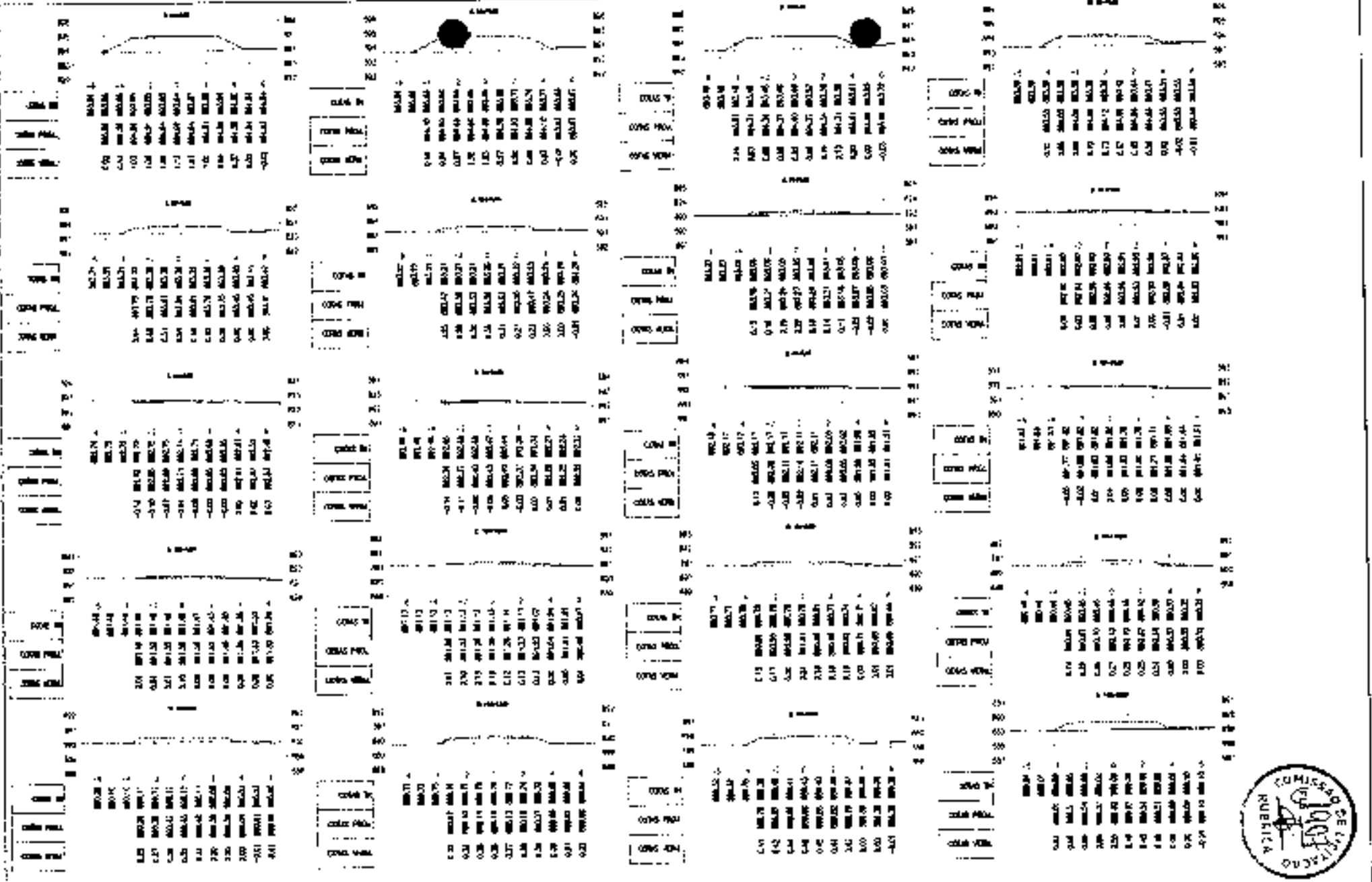

LEGENDA

ATENNO

CORTE



PREFEITURA MUNICIPAL DE GUARACIABA DO NORTE

RECUPERAÇÃO DE ESTRADAS VICINAIS NO MUNICÍPIO DE GUARACIABA DO NORTE-CE - PT 106527003

SEÇÕES TRANSVERSAIS



11 / 20

1:250

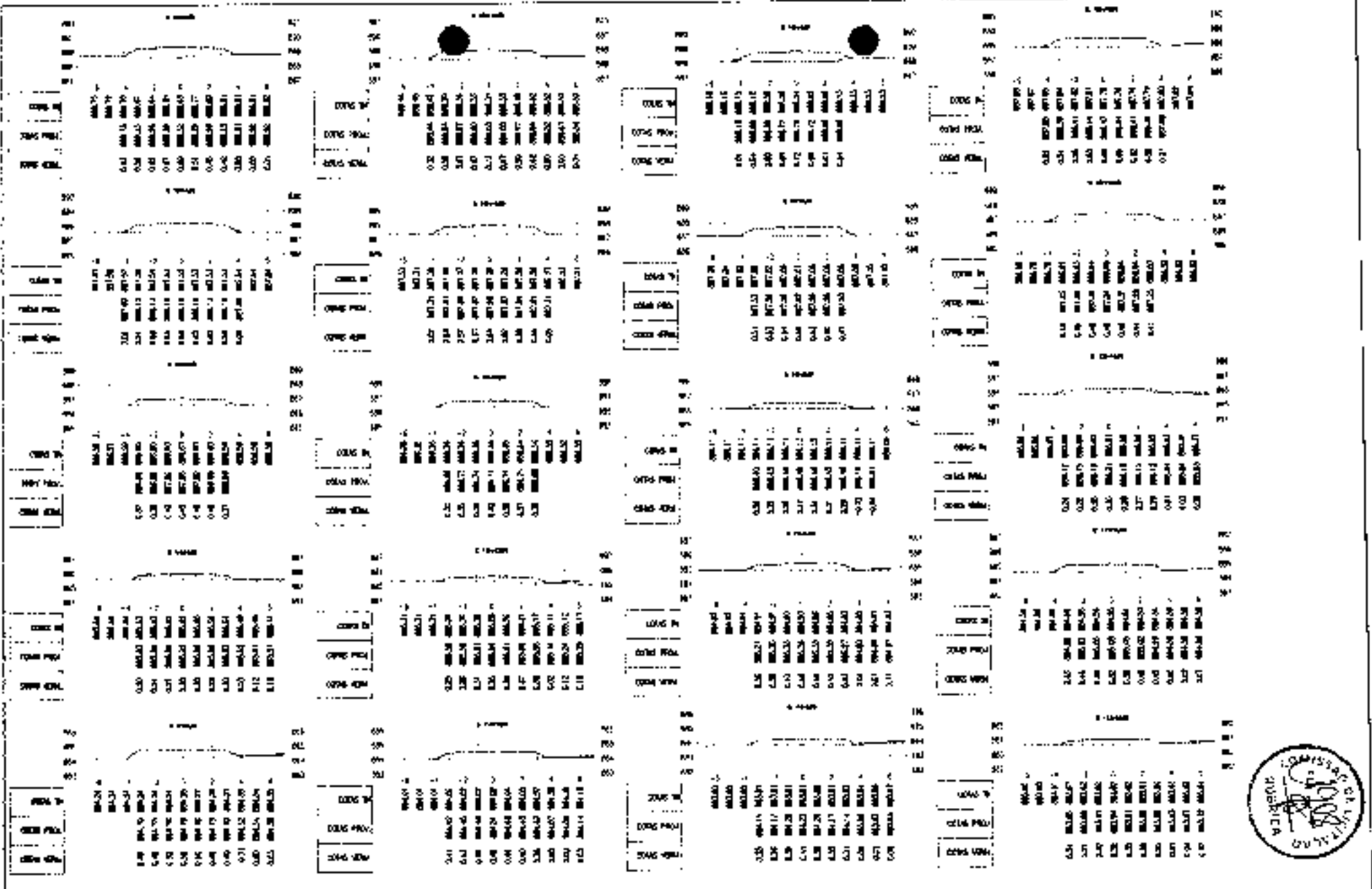

LEGENDA

- ATERRO
- CORTE



PREFEITURA MUNICIPAL DE GUARACIABA DO NORTE
 RECUPERAÇÃO DE ESTRADAS VICINAIS NO MUNICÍPIO DE GUARACIABA DO NORTE-CE - PT 1086270-03
 SEÇÕES TRANSVERSAIS

12 / 20
1:250



LEGENDA:

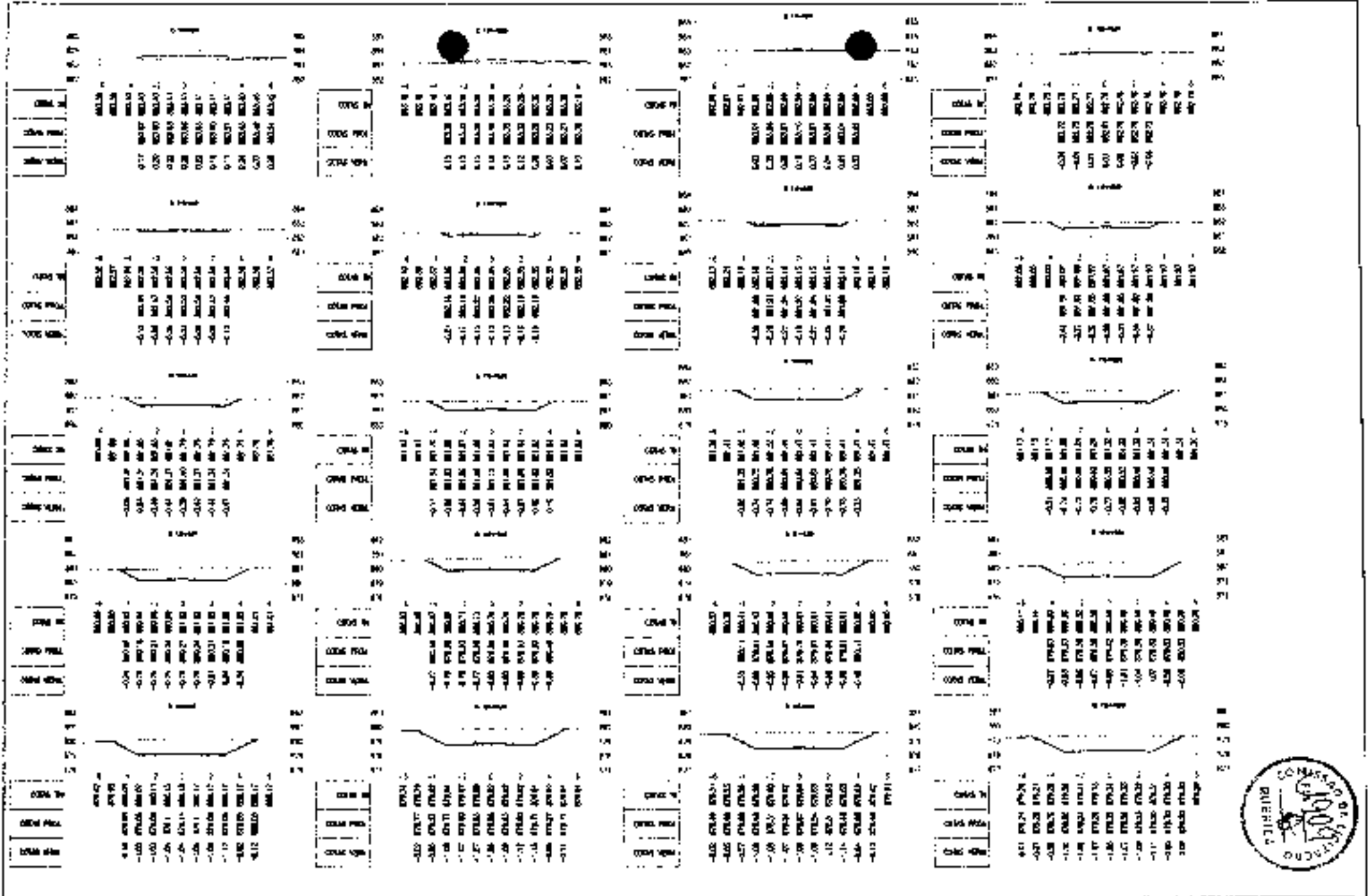

-  ATERRO
-  CORTE



PREFEITURA MUNICIPAL DE GUARACIÃ DO NORTE OCUPAÇÃO DE ESTRADAS VICINAIS NO MUNICÍPIO DE GUARACIÃ DO NORTE-CE - PI 1086270-13 SEÇÕES TRANSVERSAIS		FOLHA Nº 13 / 20
ESCALA: 1:250		DATA: 12/2011



LEGENDA:

-  A"ERRO
-  COMTE

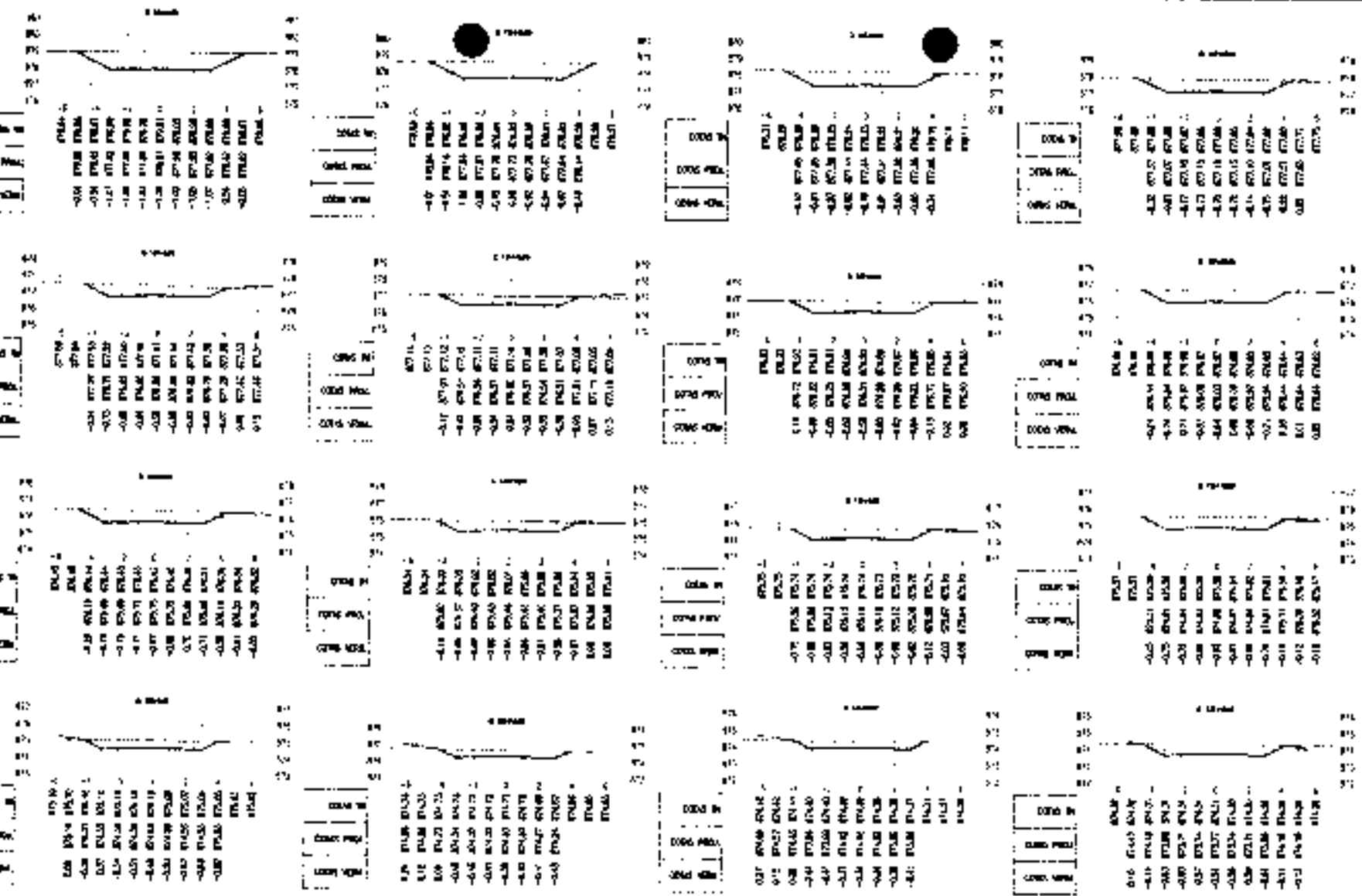



PREFEITURA MUNICIPAL DE GUARACIMBA DO NORTE
 RECUPERAÇÃO DE ESTRADAS VICINAIS NO MUNICÍPIO DE GUARACIMBA DO NORTE-CE - PT 1386270-03
 SEÇÕES TRANSVERSAIS



LEGENDA:

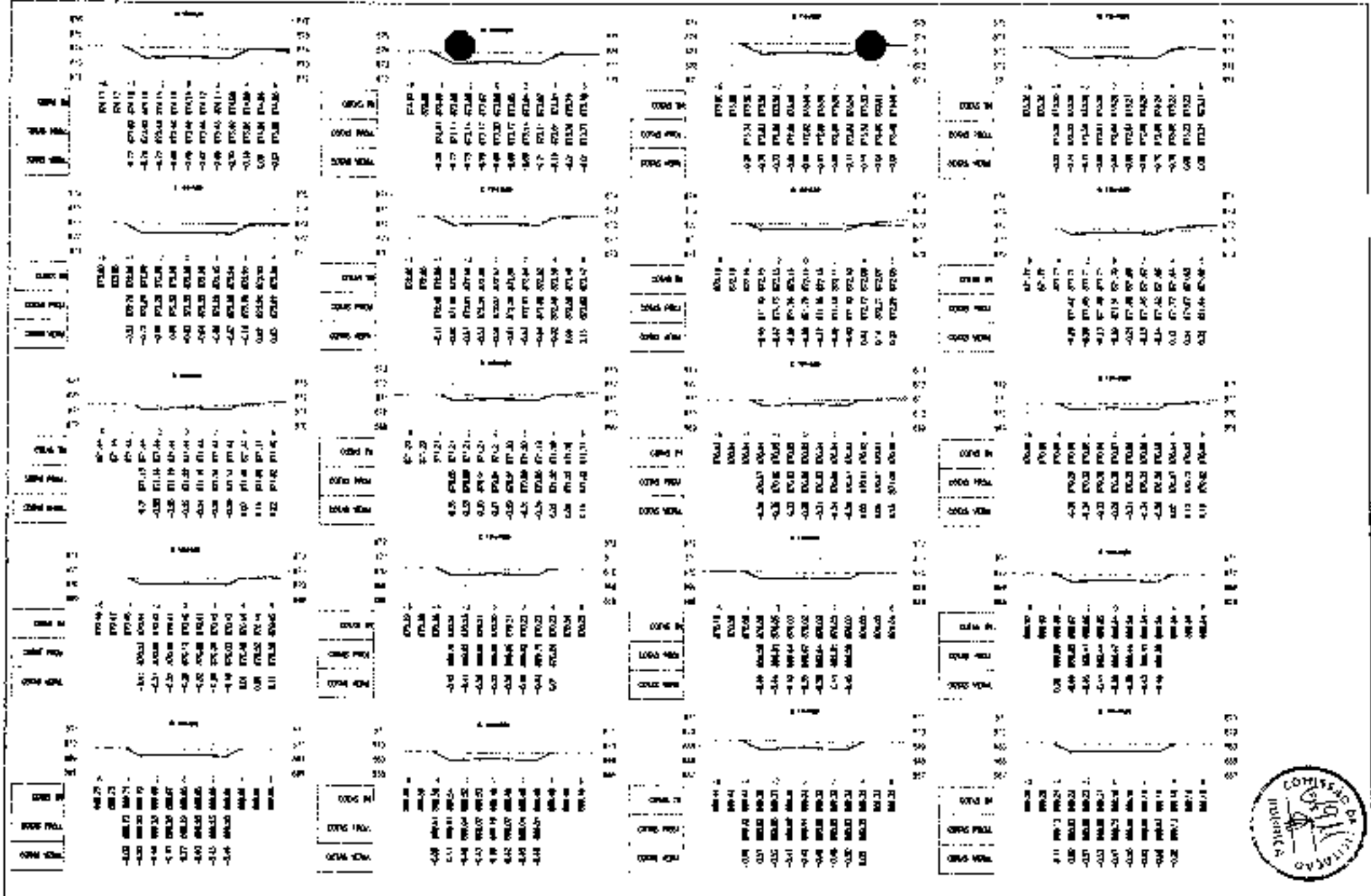

-  ATERRO
-  CONTE



	PREFEITURA MUNICIPAL DE GUARACIABA DO NORTE RECIPIFICAÇÃO DE ESTRADAS VICINAIS NO MUNICÍPIO DE GUARACIABA DO NORTE-CE - PT. 1036270-03		15 / 20
	GEÓMETRIA TRANSVERSAIS		
	PROJETO DE RECIPIFICAÇÃO DE ESTRADAS VICINAIS NO MUNICÍPIO DE GUARACIABA DO NORTE-CE - PT. 1036270-03		1/250



LEGENDA:

-  ATERRO
-  CORTE

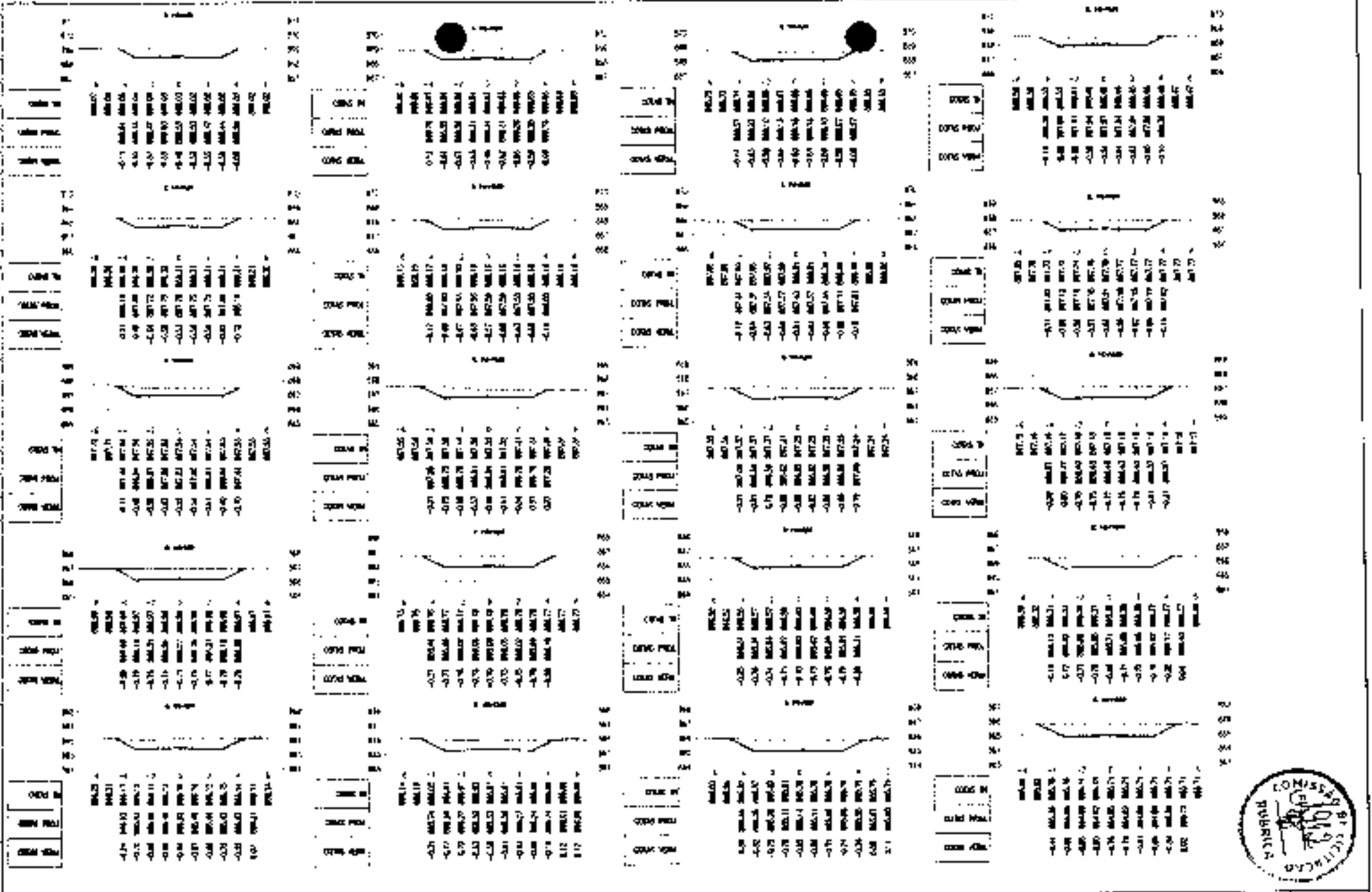

PREFEITURA MUNICIPAL DE GUARACIABA DO NORTE
 RECUPERAÇÃO DE ESTRADAS VICINAIS NO MUNICÍPIO DE GUARACIABA DO NORTE-CE - Nº 1386270-03
 SEÇÕES TRANSVERSAIS



16 / 20
 1:50

LEGENDA

-  ALIENIO
-  CORTE

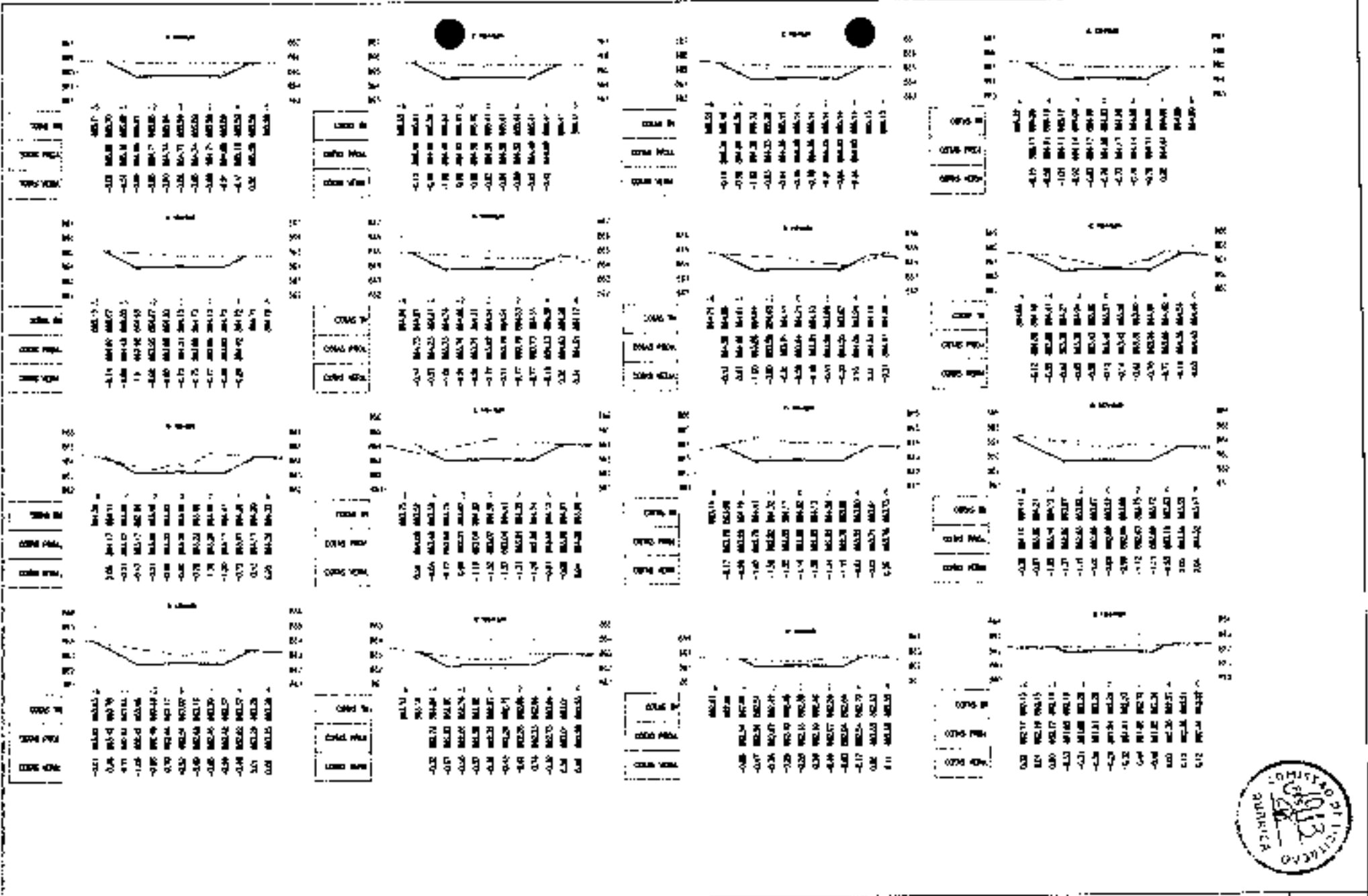



	PREFEITURA MUNICIPAL DE GUARACIABA DO NORTE RECUPERAÇÃO DE ESTRADAS VICINAIS NO MUNICÍPIO DE GUARACIABA DO NORTE - CE - DT. 1086270-03		FOLHA Nº 17 / 20
	SEÇÕES TRANSVERSAIS		DATA _____
	Rua: _____ Nº: _____		ESCALA 1/250

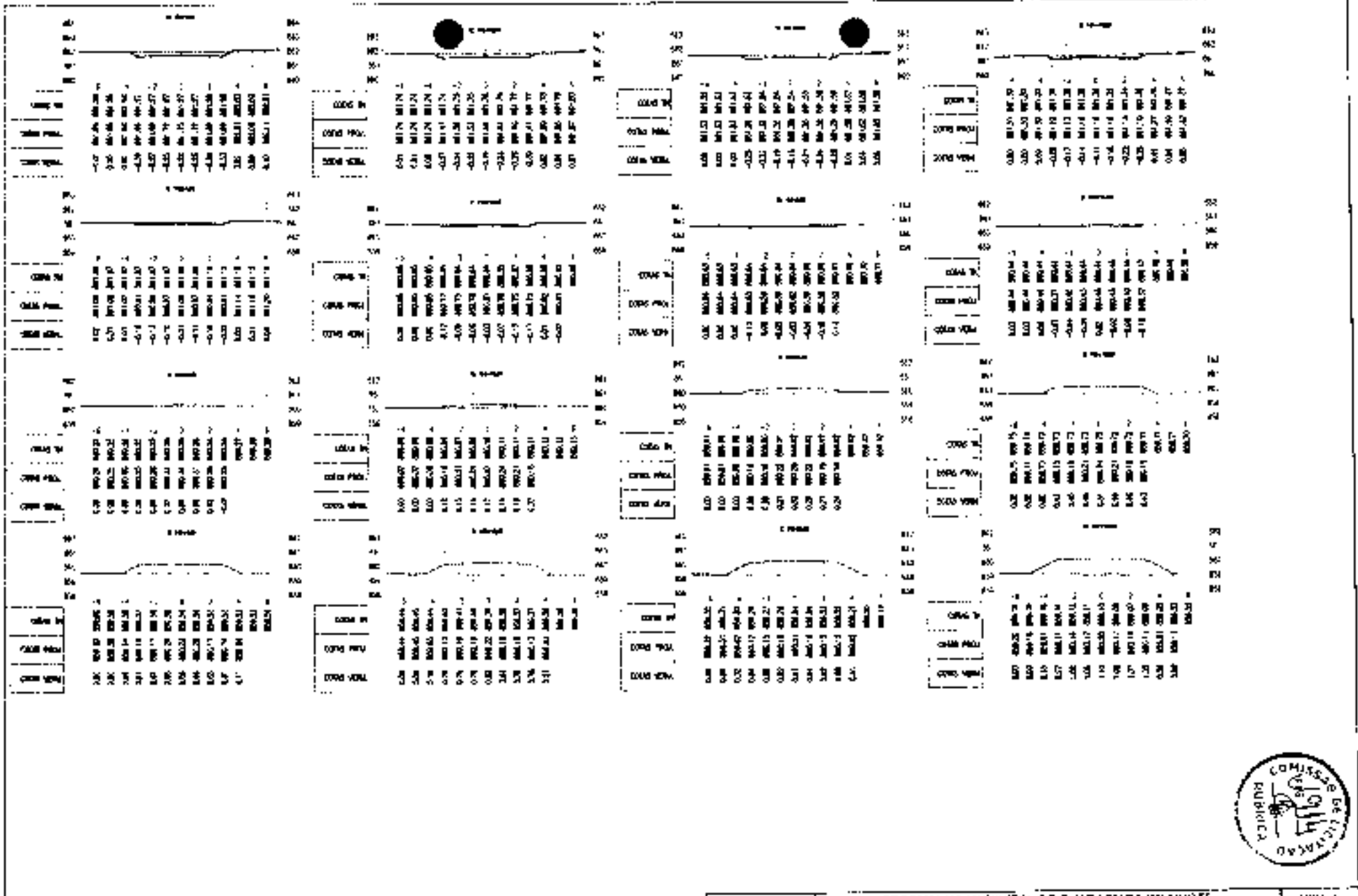

LEGENDA:

- ATERRÇO
- CORTA





JOTA BARROS PROJETS

PREFEITURA MUNICIPAL DE GUARACIABA DO NORTE

RECUPERAÇÃO DE ESTRADAS VICINAIS NO MUNICÍPIO DE GUARACIABA DO NORTE-CE - PT 1086270-00

SEÇÕES TRANSVERSAIS

PROJETO: []

DATA: []

PROJETO: []

DATA: []

PROJETO: []

DATA: []

PROJETO: []

DATA: []

PROJETO: []

DATA: []

PROJETO: []

DATA: []

PROJETO: []

DATA: []

PROJETO: []

DATA: []

PROJETO: []

DATA: []



LEGENDA:

-  ATERRU
-  CORTE

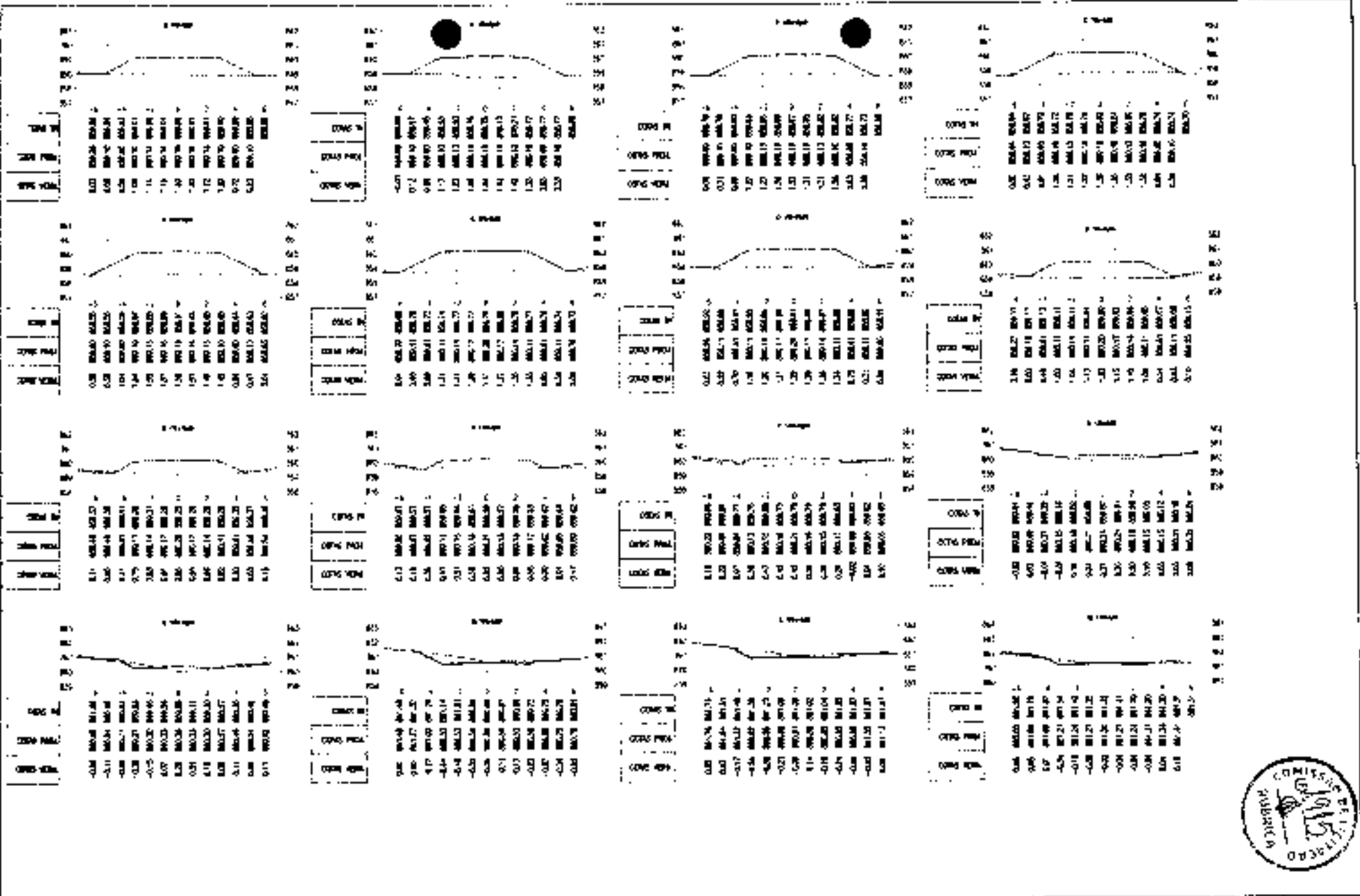

PREFEITURA MUNICIPAL DE GUARACIABA DO NORTE RECUPERAÇÃO DE ESTRADAS VICINIAS NO MUNICÍPIO DE GUARACIABA DO NORTE-CE - PT 1086270-03 SEÇÕES TRANSVERSAIS		19 / 20 1:250
PROJETO	ELABORADO POR	
DATA	APROVADO POR	





0 1000 2000

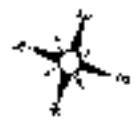

0 1000 2000



PREFEITURA MUNICIPAL DE GUARACIABA DO NORTE

RECUPERAÇÃO DE ESTRADAS VICINAIS NO MUNICÍPIO DE GUARACIABA DO NORTE - R.F. 1385776-33

SINALIZAÇÃO VIÁRIA

PROJETO DE: _____

PROJETO DE: _____

PROJETO DE: _____

1 / 07

1 1000

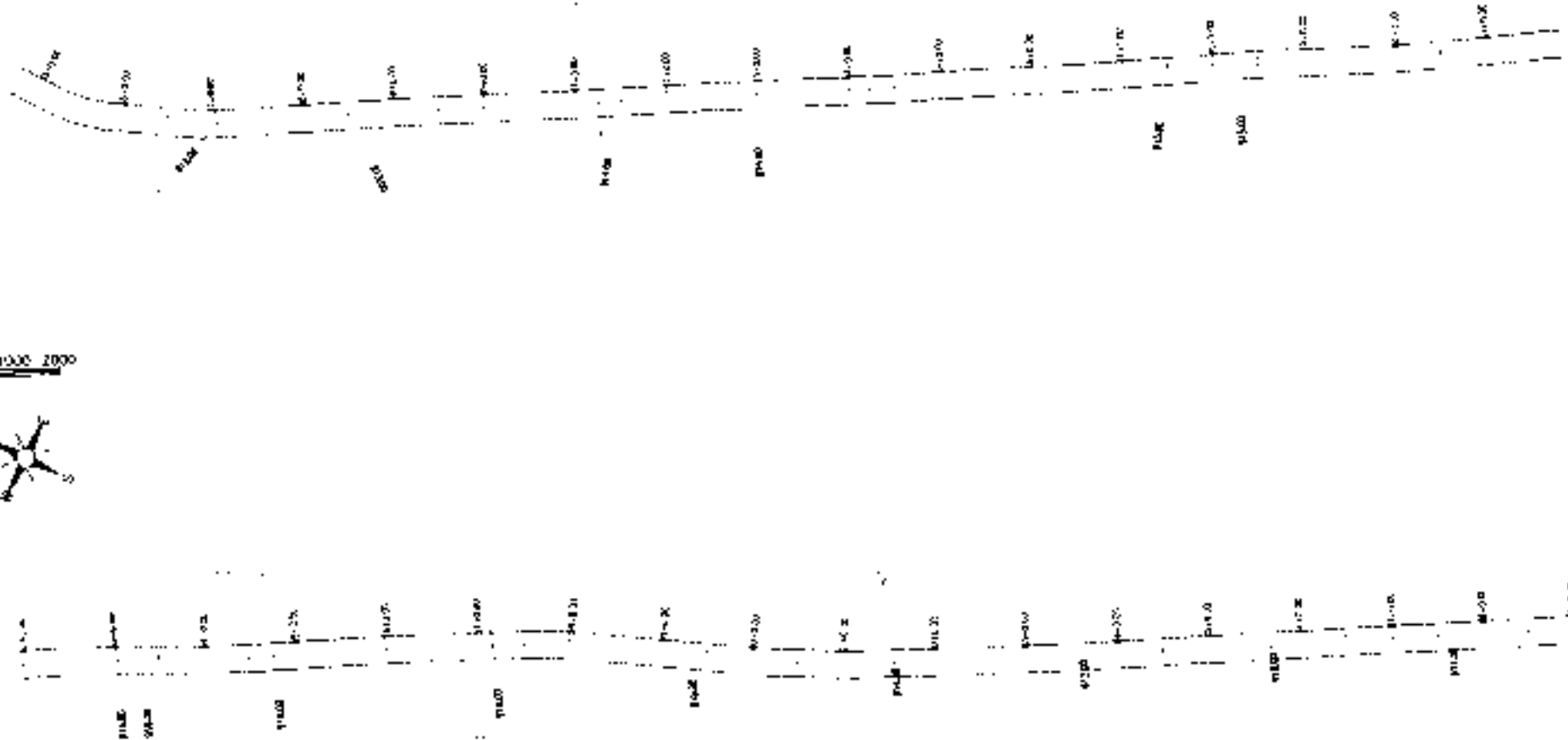
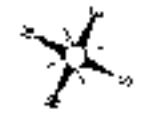
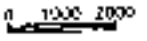

PREFEITURA MUNICIPAL DE GUARACIABA DO NORTE
 RECUPERAÇÃO DE ESTRADAS VICINAIS NO MUNICÍPIO DE GUARACIABA
 DO NORTE-CE - PT 1100270-03
 SINALIZAÇÃO VIÁRIA

PROJETO: SINALIZAÇÃO VIÁRIA DE ESTRADAS VICINAIS
 DATA: 10 de Junho de 2008

2 / 07
 1:1000





0 1000 2000



0 1000 2000

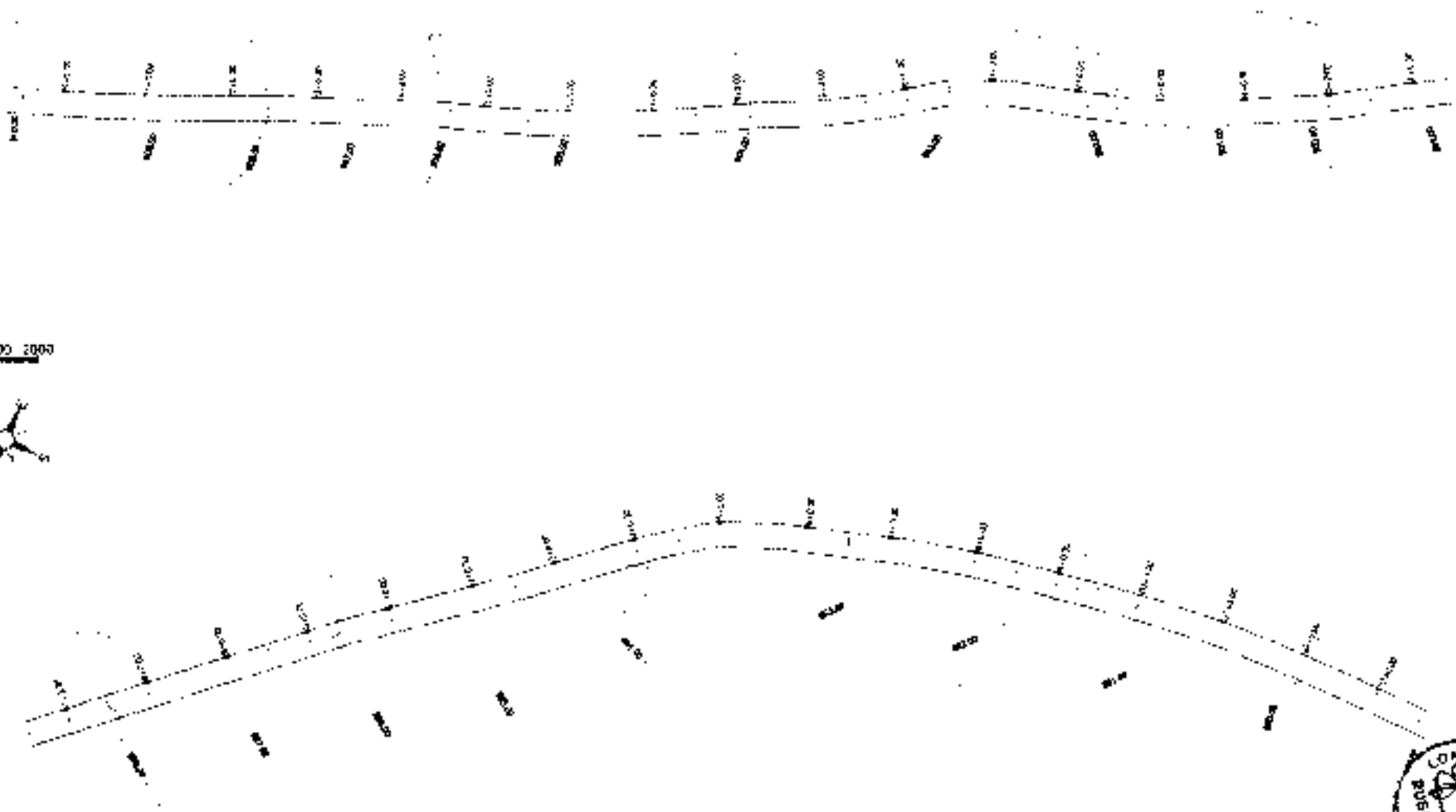

PREFEITURA MUNICIPAL DE GUARACIARA DO NORTE		DATA
RECUPERAÇÃO DE ESTRADAS VICINAIS NO MUNICÍPIO DE GUARACIARA DO NORTE CL - PY 1086270-00		3 / 07
BINALIZAÇÃO VIÁRIA		FOLHA
Nº 01/2007		17/100

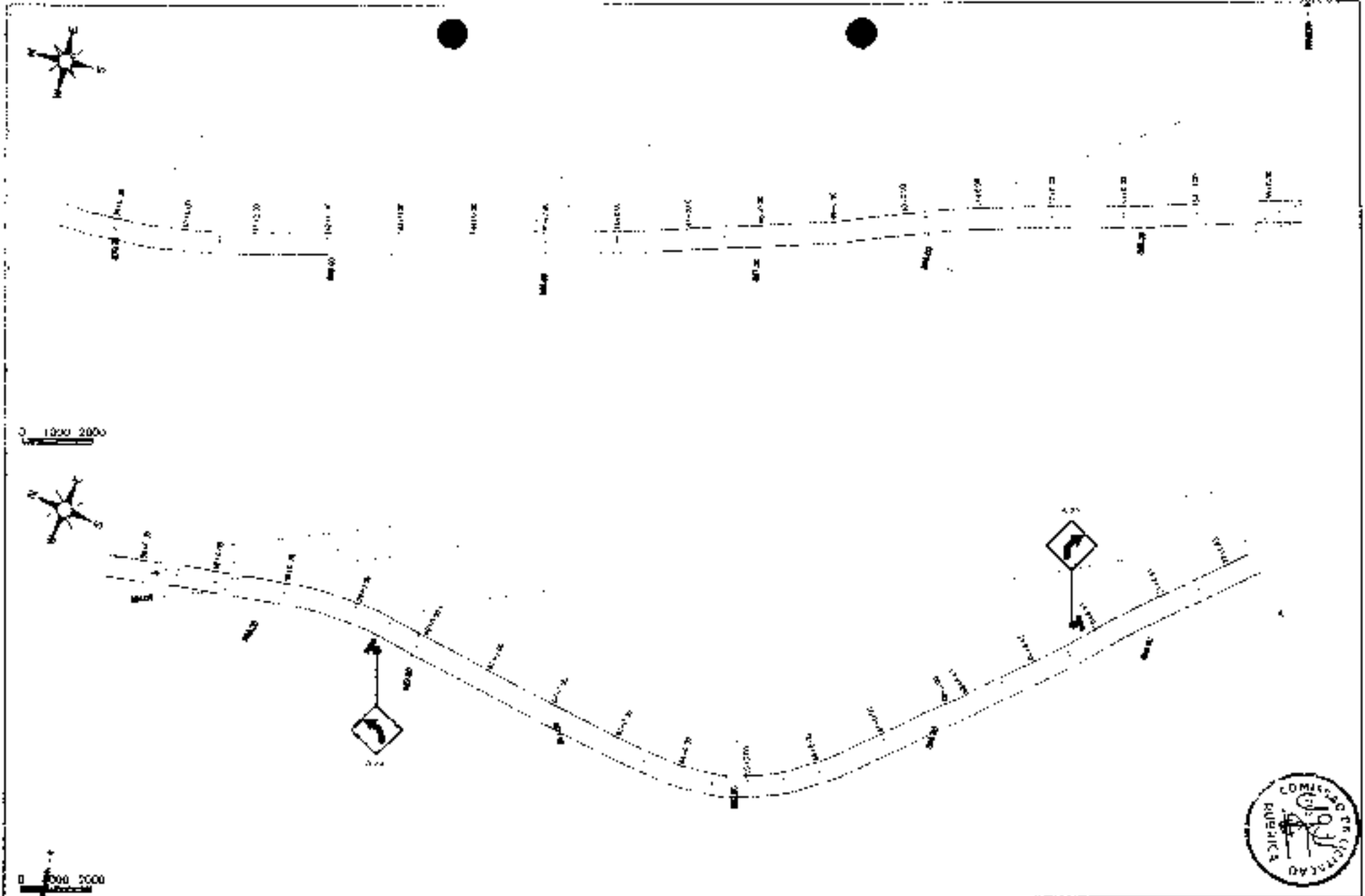

PREFEITURA MUNICIPAL DE GUARACIABA DO NORTE RECUPERAÇÃO DE ESTRADAS VICINAIS NO MUNICÍPIO DE GUARACIABA DO NORTE-CE - PT 158627003		Nº 5 / 07
SINALIZAÇÃO VÁRIA		DATA 1 / 2010
ELABORADO POR PROJETO	ENG. CIVIL JOSÉ BARROS JUNIOR RUA... Nº...	
APROVADO POR PROJETO	ENG. CIVIL JOSÉ BARROS JUNIOR RUA... Nº...	



0 1000 2000

0m - 0



PREFEITURA MUNICIPAL DE GUARACIABA DO NORTE		DATA
RECUPERAÇÃO DE ESTRADAS VICINAIS NO MUNICÍPIO DE GUARACIABA DO NORTE-CE - PT 1086270 03		6 / 07
SINALIZAÇÃO VIÁRIA		ESCALA
AUTORIA: PAULO C. LOPES / ENGENHEIRO RESPONSÁVEL: JOSÉ BARROS		1:1000
PROJETO: LUIZ CARLOS DE MENEZES		

Posicionamento transversal

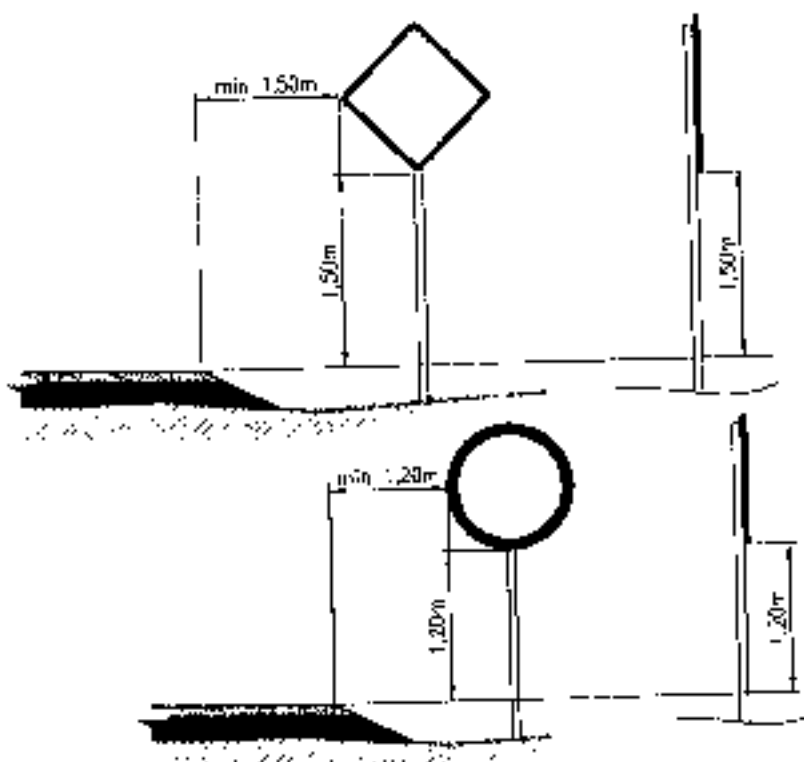

PLACAS DE ADVERTENCIA

PLACAS	CÓDIGO DEBENEFÍCIOS	
	Cal	Top

PLACAS DE ADVERTENCIA

PLACAS	CÓDIGO DEBENEFÍCIOS	
	Cal	Top

As Placas de Advertência têm as seguintes características:

- Tudo - Placa
- Dir. esquerda - Azul
- Dir. direita - Amarelo
- Tudo - Placa
- Dir. esquerda - Azul
- Dir. direita - Amarelo
- Tudo - Placa
- Dir. esquerda - Azul
- Dir. direita - Amarelo



<p>JOTA BARROS FREIRE</p>	PREFEITURA MUNICIPAL DE GUARACIABA DO NORTE RECUPERAÇÃO DE ESTRADAS VICINAIS NO MUNICÍPIO DE GUARACIABA DO NORTE-CE Nº 1986273-13 SINALIZAÇÃO VIÁRIA		7 / 07
	SEM FRC		SEM FRC
	[Empty space for additional details]		

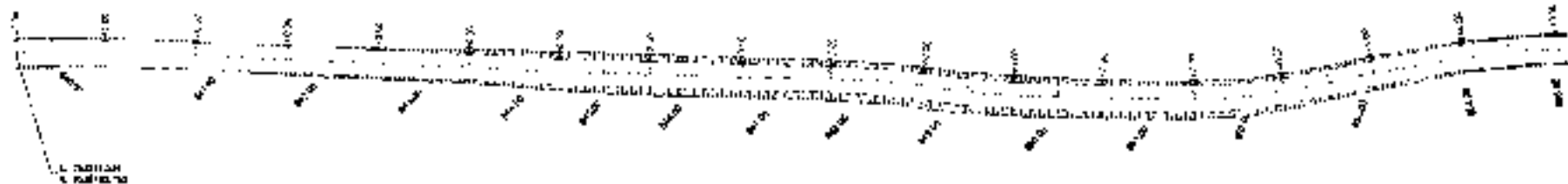
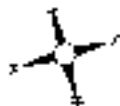

1:200 2000



0+00	0+10	0+20	0+30	0+40	0+50	0+60	0+70	0+80	0+90	1+00
0+00	0+10	0+20	0+30	0+40	0+50	0+60	0+70	0+80	0+90	1+00
0+00	0+10	0+20	0+30	0+40	0+50	0+60	0+70	0+80	0+90	1+00
0+00	0+10	0+20	0+30	0+40	0+50	0+60	0+70	0+80	0+90	1+00

100M	50M	20M	10M	5M	2M	1M	0,5M	0,2M



PREFEITURA MUNICIPAL DE GUARACIABA DO NORTE
 RECUPERAÇÃO DE ESTRADAS VICINAIS NO MUNICÍPIO DE GUARACIABA DO NORTE-CE - PT 138670-03
 ESTAQUEAMENTO E PERFIL LONGITUDINAL



1 / 4
 138670-03

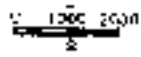
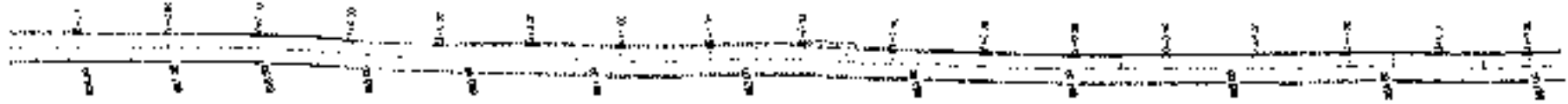

Est.	0+00	0+10	0+20	0+30	0+40	0+50	0+60	0+70	0+80	0+90	1+00
Alt. (m)	11.5	11.0	10.5	10.0	9.5	9.0	8.5	8.0	7.5	7.0	6.5
Proj. (m)	11.5	11.0	10.5	10.0	9.5	9.0	8.5	8.0	7.5	7.0	6.5
Proj. (m)	11.5	11.0	10.5	10.0	9.5	9.0	8.5	8.0	7.5	7.0	6.5



PREFEITURA MUNICIPAL DE GUARACIABA DO NORTE
 RECUPERAÇÃO DE ESTRADAS VICIAIS NO MUNICÍPIO DE GUARACIABA DO NORTE-CE - P.º 1082/063
 ESTAQUEAMENTO E PERFIL LONGITUDINAL

PROJETA: DR. CARLOS EDUARDO MORAES TORRES ALMEIDA
 ARQUIT.: T.º ENG.º CARLOS EDUARDO MORAES TORRES ALMEIDA

2 / 40
 11/10/2006
 11/10/2006

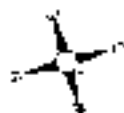

0+00	0+100	0+200	0+300	0+400	0+500	0+600	0+700	0+800	0+900	1+000
0+00	0+100	0+200	0+300	0+400	0+500	0+600	0+700	0+800	0+900	1+000
0+00	0+100	0+200	0+300	0+400	0+500	0+600	0+700	0+800	0+900	1+000
0+00	0+100	0+200	0+300	0+400	0+500	0+600	0+700	0+800	0+900	1+000
0+00	0+100	0+200	0+300	0+400	0+500	0+600	0+700	0+800	0+900	1+000
0+00	0+100	0+200	0+300	0+400	0+500	0+600	0+700	0+800	0+900	1+000
0+00	0+100	0+200	0+300	0+400	0+500	0+600	0+700	0+800	0+900	1+000
0+00	0+100	0+200	0+300	0+400	0+500	0+600	0+700	0+800	0+900	1+000
0+00	0+100	0+200	0+300	0+400	0+500	0+600	0+700	0+800	0+900	1+000
0+00	0+100	0+200	0+300	0+400	0+500	0+600	0+700	0+800	0+900	1+000

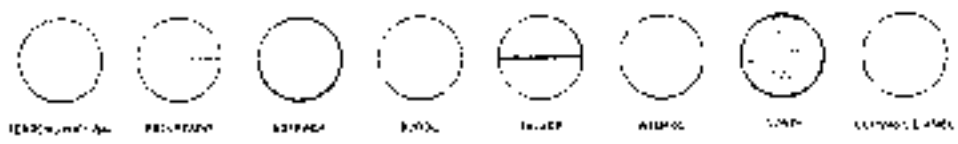

PREFEITURA MUNICIPAL DE GUARACABA DO NORTE
 RECUPERAÇÃO DE ESTRADAS VICINAIS NO MUNICÍPIO DE GUARACABA DO NORTE - CE - PT 1096270-03
 ESTAQUEAMENTO E PERFIL LONGITUDINAL



3140
 2020

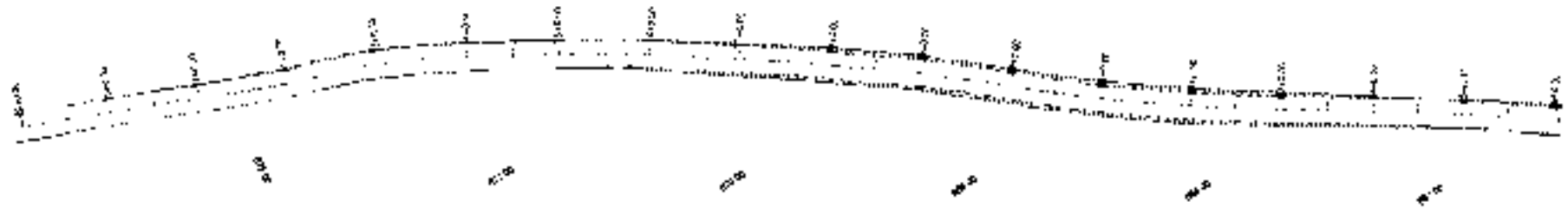

1:1000

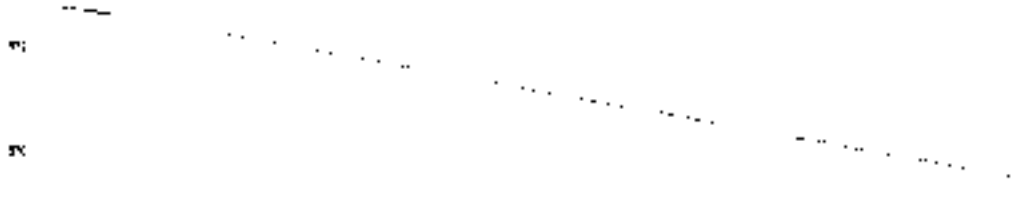

0+00	0+10	0+20	0+30	0+40	0+50	0+60	0+70	0+80	0+90	0+100	0+110	0+120	0+130	0+140	0+150	0+160	0+170	0+180	0+190	0+200
0+00	0+10	0+20	0+30	0+40	0+50	0+60	0+70	0+80	0+90	0+100	0+110	0+120	0+130	0+140	0+150	0+160	0+170	0+180	0+190	0+200
0+00	0+10	0+20	0+30	0+40	0+50	0+60	0+70	0+80	0+90	0+100	0+110	0+120	0+130	0+140	0+150	0+160	0+170	0+180	0+190	0+200
0+00	0+10	0+20	0+30	0+40	0+50	0+60	0+70	0+80	0+90	0+100	0+110	0+120	0+130	0+140	0+150	0+160	0+170	0+180	0+190	0+200

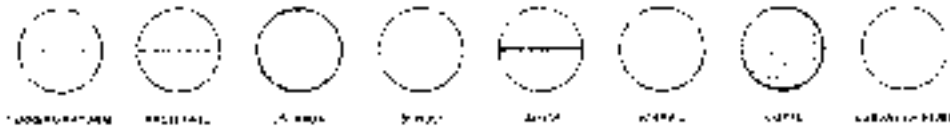

JOTA BARROS
PROJETOS

PREFEITURA MUNICIPAL DE GUARACIABA DO NORTE

RECUPERAÇÃO DE ESTRADAS VICINAIS NO MUNICÍPIO DE GUARACIABA DO NORTE - CE - R1106270-03

ESTAQUEAMENTO E PERFIL LONGITUDINAL

6 / 40



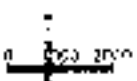
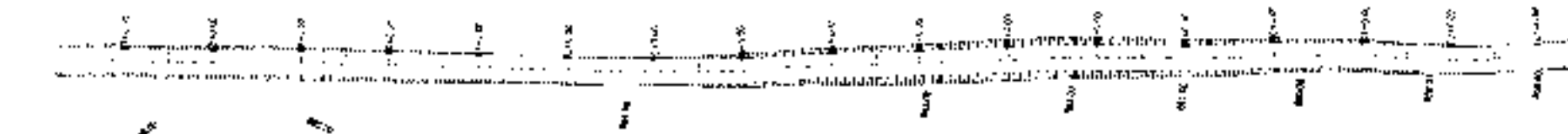

Estação	0+00	0+10	0+20	0+30	0+40	0+50	0+60	0+70	0+80	0+90	1+00
Alt. (m)	100	100	100	100	100	100	100	100	100	100	100
Alt. (m)	100	100	100	100	100	100	100	100	100	100	100
Alt. (m)	100	100	100	100	100	100	100	100	100	100	100



PREFEITURA MUNICIPAL DE GUARACIABA DO NORTE
 RECUPERAÇÃO DE ESTRADAS VICINAIS NO MUNICÍPIO DE GUARACIABA DO NORTE DE - PT 1065270-03
 ESTAQUEAMENTO E PERFIL LONGITUDINAL

PROJETO	PROJETO DE RECUPERAÇÃO DE ESTRADAS VICINAIS
LOCAL	MUNICÍPIO DE GUARACIABA DO NORTE - PERNAMBUCO

Nº 614
 DATA 10/03/2010





1:1000 2010

0+00
0+10
0+20
0+30
0+40
0+50
0+60
0+70
0+80
0+90
1+00

0+00
0+10
0+20
0+30
0+40
0+50
0+60
0+70
0+80
0+90
1+00

0+00
0+10
0+20
0+30
0+40
0+50
0+60
0+70
0+80
0+90
1+00

0+00
0+10
0+20
0+30
0+40
0+50
0+60
0+70
0+80
0+90
1+00

0+00
0+10
0+20
0+30
0+40
0+50
0+60
0+70
0+80
0+90
1+00

0+00
0+10
0+20
0+30
0+40
0+50
0+60
0+70
0+80
0+90
1+00

0+00
0+10
0+20
0+30
0+40
0+50
0+60
0+70
0+80
0+90
1+00

0+00
0+10
0+20
0+30
0+40
0+50
0+60
0+70
0+80
0+90
1+00

0+00
0+10
0+20
0+30
0+40
0+50
0+60
0+70
0+80
0+90
1+00

0+00
0+10
0+20
0+30
0+40
0+50
0+60
0+70
0+80
0+90
1+00

0+00
0+10
0+20
0+30
0+40
0+50
0+60
0+70
0+80
0+90
1+00

0+00
0+10
0+20
0+30
0+40
0+50
0+60
0+70
0+80
0+90
1+00

0+00
0+10
0+20
0+30
0+40
0+50
0+60
0+70
0+80
0+90
1+00

0+00
0+10
0+20
0+30
0+40
0+50
0+60
0+70
0+80
0+90
1+00

0+00
0+10
0+20
0+30
0+40
0+50
0+60
0+70
0+80
0+90
1+00

0+00
0+10
0+20
0+30
0+40
0+50
0+60
0+70
0+80
0+90
1+00

0+00
0+10
0+20
0+30
0+40
0+50
0+60
0+70
0+80
0+90
1+00

0+00
0+10
0+20
0+30
0+40
0+50
0+60
0+70
0+80
0+90
1+00

0+00
0+10
0+20
0+30
0+40
0+50
0+60
0+70
0+80
0+90
1+00

0+00
0+10
0+20
0+30
0+40
0+50
0+60
0+70
0+80
0+90
1+00

0+00
0+10
0+20
0+30
0+40
0+50
0+60
0+70
0+80
0+90
1+00

0+00
0+10
0+20
0+30
0+40
0+50
0+60
0+70
0+80
0+90
1+00



PROJEÇÃO



ALCANTARA



COLETA



ALCANTARA



ALCANTARA



ALCANTARA



ALCANTARA



ALCANTARA



JOTA BARROS
ENGENHARIA

PREFEITURA MUNICIPAL DE GUARACIABA DO NORTE		714
RECUPERAÇÃO DE ESTRADAS VICINAS NO MUNICÍPIO DE GUARACIABA DO NORTE DE - PT 1006270-00		
ESTAQUEAMENTO E PERFIL LONGITUDINAL		
PROJETA	ENGENHEIRO RESPONSÁVEL	714
PROJETA	ENGENHEIRO RESPONSÁVEL	714



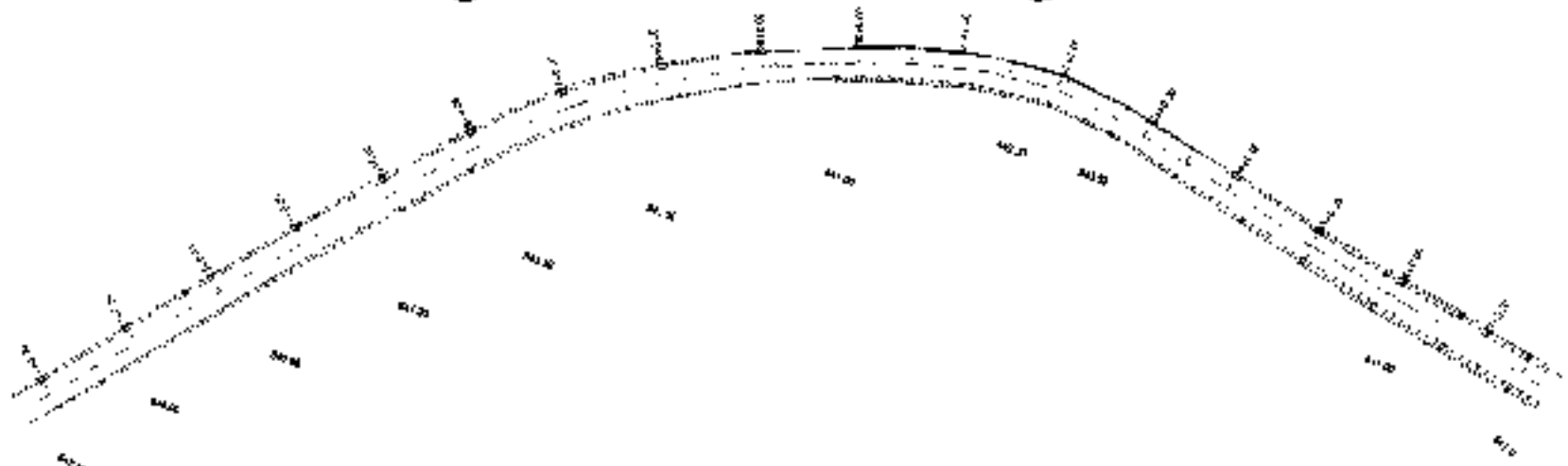
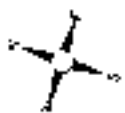

1:000 3000

14
13
12
11
10
9
8
7
6
5
4
3
2
1



PREFEITURA MUNICIPAL DE GUARACAMA DO NORTE

RECUPERAÇÃO DE ESTRADAS VICINAIS NO MUNICÍPIO DE GUARACAMA
DO NORTE - CE - PT 1186273-03

ESTAQUEAMENTO E PERFIL LONGITUDINAL

PROJETO: ENG. CIVIL ANDRÉ CARVALHO TORRES - CARVALHO TORRES

EMPRESA: ENGENHARIA DE PROJETOS, S/A - ENPRO, S/A



8 / 4
11/1008
11/1008

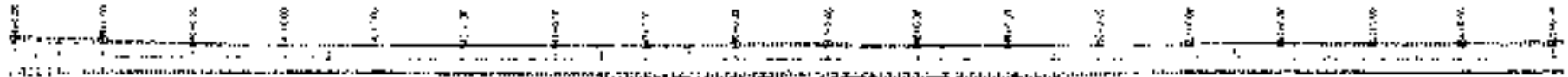

0+00 0+200 0+400 0+600 0+800 1+000

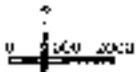

0+00	0+200	0+400	0+600	0+800	1+000
10	10	10	10	10	10
20	20	20	20	20	20
30	30	30	30	30	30
40	40	40	40	40	40
50	50	50	50	50	50



PREFEITURA MUNICIPAL DE GUARACIÁ DO NORTE
 RECUPERAÇÃO DE ESTRADAS VICINAIS NO MUNICÍPIO DE GUARACIÁ DO NORTE - PI 1056210-09
 ESTAQUEAMENTO E PERFIL LONGITUDINAL



9 / 40
 2012

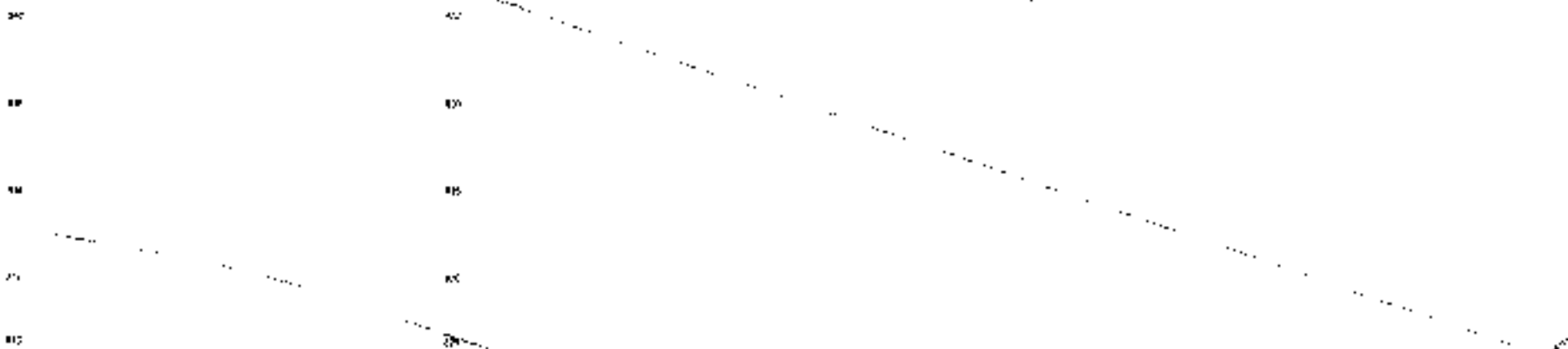
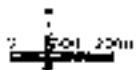
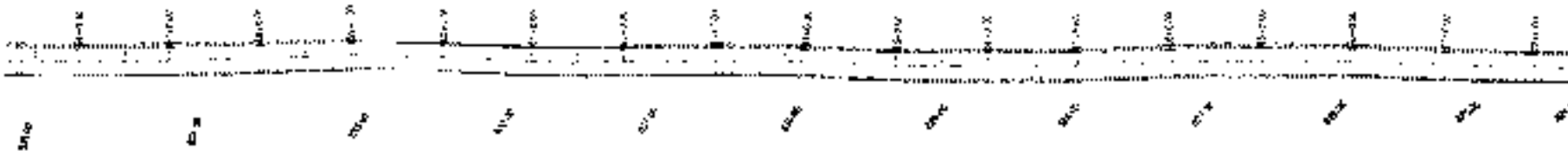
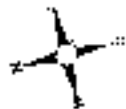

1	2	3	4	5	6	7	8	9	10	11	12	13	14	15	16	17	18	19	20
4	5	6	7	8	9	10	11	12	13	14	15	16	17	18	19	20	21	22	23
1	2	3	4	5	6	7	8	9	10	11	12	13	14	15	16	17	18	19	20
3	4	5	6	7	8	9	10	11	12	13	14	15	16	17	18	19	20	21	22

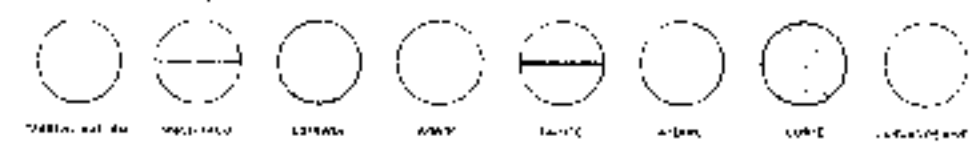



PREFEITURA MUNICIPAL DE GUARACIARA DO NORTE	
RECUPERAÇÃO DE ESTRADAS VICINAIS NO MUNICÍPIO DE GUARACIARA DO NORTE-CE - PT 1066270-01	
ESTAQUEAMENTO E PERFIL LONGITUDINAL	
PROPOSTA	ENCARGOS DE PROJEÇÃO E EXECUÇÃO DE OBRAS
APROVADO	10/10/2011

10/10

10/10



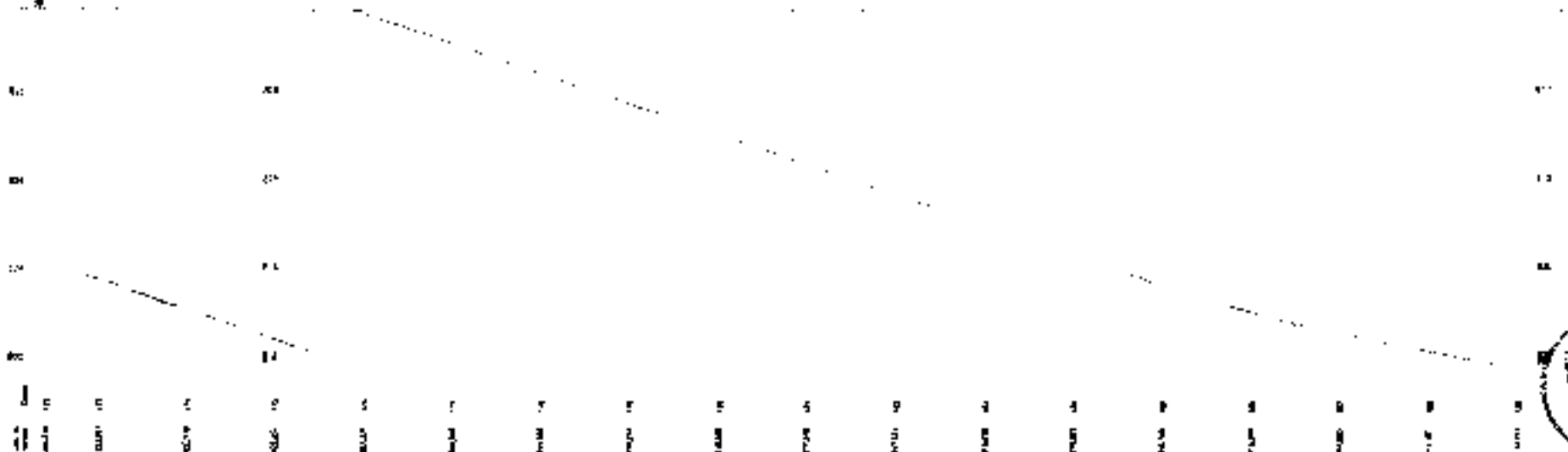
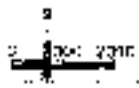
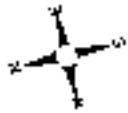

ESTAC.	ALCANTARILHA	DESMO.	DESMO.	DESMO.	DESMO.	DESMO.	DESMO.	DESMO.	DESMO.	DESMO.	DESMO.	DESMO.	DESMO.	DESMO.	DESMO.	DESMO.	DESMO.	DESMO.	DESMO.
0+00																			
0+10																			
0+20																			
0+30																			
0+40																			
0+50																			
0+60																			
0+70																			
0+80																			
0+90																			
0+100																			
0+200																			
0+300																			
0+400																			
0+500																			
0+600																			
0+700																			
0+800																			
0+900																			
0+1000																			
0+1100																			
0+1200																			
0+1300																			

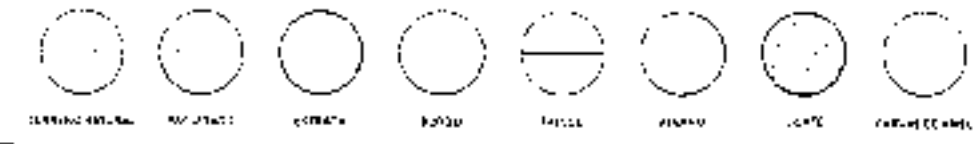

<p>PREFEITURA MUNICIPAL DE GUARACIABA DO NORTE</p> <p>RECUPERAÇÃO DE ESTRADAS VICINAS NO MUNICÍPIO DE GUARACIABA DO NORTE-CE - PT 1086270-03</p> <p>ESTADUEAMENTO E PERFIL LONGITUDINAL</p>	<p>11/0</p>
	<p>PROJETO: PROJ. DE OBRAS DE RECONSTRUÇÃO E RECONSTR. DE OBRAS DE RECONSTR.</p>

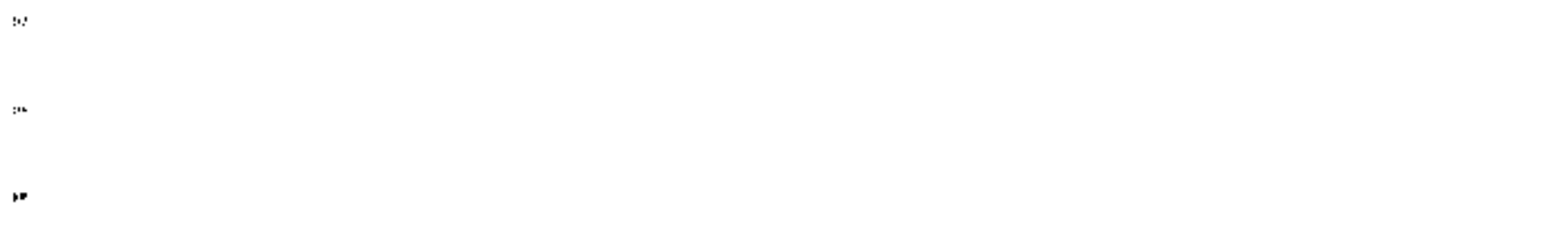
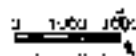
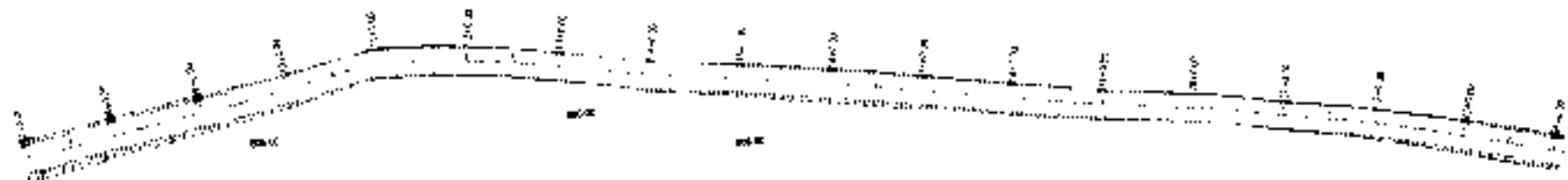

0+00	0+10	0+20	0+30	0+40	0+50	0+60	0+70	0+80	0+90	1+00	1+10	1+20	1+30	1+40	1+50	1+60	1+70	1+80	1+90	2+00
10	10	10	10	10	10	10	10	10	10	10	10	10	10	10	10	10	10	10	10	10
10	10	10	10	10	10	10	10	10	10	10	10	10	10	10	10	10	10	10	10	10
10	10	10	10	10	10	10	10	10	10	10	10	10	10	10	10	10	10	10	10	10

TOPOGRAFIA	PROJETO	SISTEMA	NORTE	EIXO	ATOPOS	CORTE	CALÇADA



PREFEITURA MUNICIPAL DE GUARACIABA DO NORTE RECUPERAÇÃO DE ESTRADAS VICINAIS AO MUNICÍPIO DE GUARACIABA DO NORTE - CE - P1 1086290-00		13/4
EBTAGUEAMENTO E PERFIL LONGITUDINAL		
LOCAL: RUA DA LARANJEIRA, GUARACIABA DO NORTE, CE	PROJETO:	DATA:



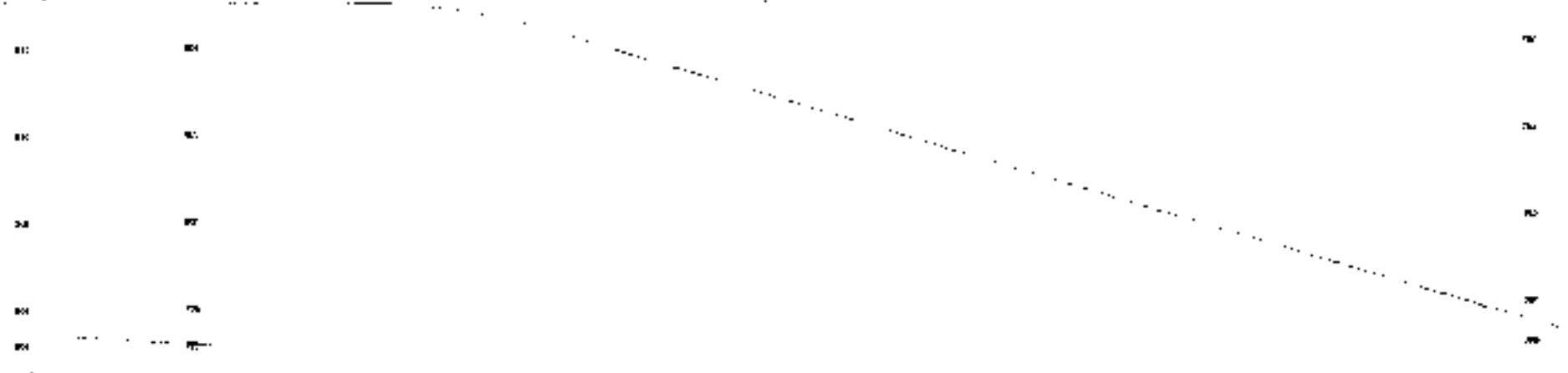

1	2	3	4	5	6	7	8	9	10	11	12	13	14	15	16	17	18	19	20
100	100	100	100	100	100	100	100	100	100	100	100	100	100	100	100	100	100	100	100
100	100	100	100	100	100	100	100	100	100	100	100	100	100	100	100	100	100	100	100
100	100	100	100	100	100	100	100	100	100	100	100	100	100	100	100	100	100	100	100



- TERRELA BRANCA
- FOCINHO
- LIMBO
- SARZO
- TAPETE
- ATRAVO
- LORIL
- CUPULAS TUBO



PREFEITURA MUNICIPAL DE GUARACIABA DO NORTE
RECUPERAÇÃO DE ESTRADAS VICINAIS NO MUNICÍPIO DE GUARACIABA DO NORTE-CE - FT 1086270-03
ESTABOECIMENTO E PERFIL LONGITUDINAL

PROJETO: RECUPERAÇÃO DE ESTRADAS VICINAIS NO MUNICÍPIO DE GUARACIABA DO NORTE-CE - FT 1086270-03
 AUTORA: JOYA BARROS PROJETO

14 / 40
 Nº 100
 2010

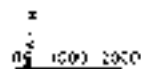

1	2	3	4	5	6	7	8	9	10	11	12	13	14	15	16	17	18
100	100	100	100	100	100	100	100	100	100	100	100	100	100	100	100	100	100
100	100	100	100	100	100	100	100	100	100	100	100	100	100	100	100	100	100
100	100	100	100	100	100	100	100	100	100	100	100	100	100	100	100	100	100



- 
TERRA EN BR
- 
MOISTADO
- 
ZEPEDA
- 
BORDO
- 
FAIXA
- 
CANAL
- 
CTR
- 
VAZÃO DE ÁGUA



PREFEITURA MUNICIPAL DE GUARACIABA DO NORTE
 REQUALIFICAÇÃO DE ESTRADAS VICINAIS NO MUNICÍPIO DE GUARACIABA DO NORTE-CE - PT 1085273-03
 ESTACQUEAMENTO E PERFIL LONGITUDINAL
 PROJETO: JOTA BARROS ENGENHEIRO
 DATA: 10/09/2010

15/43

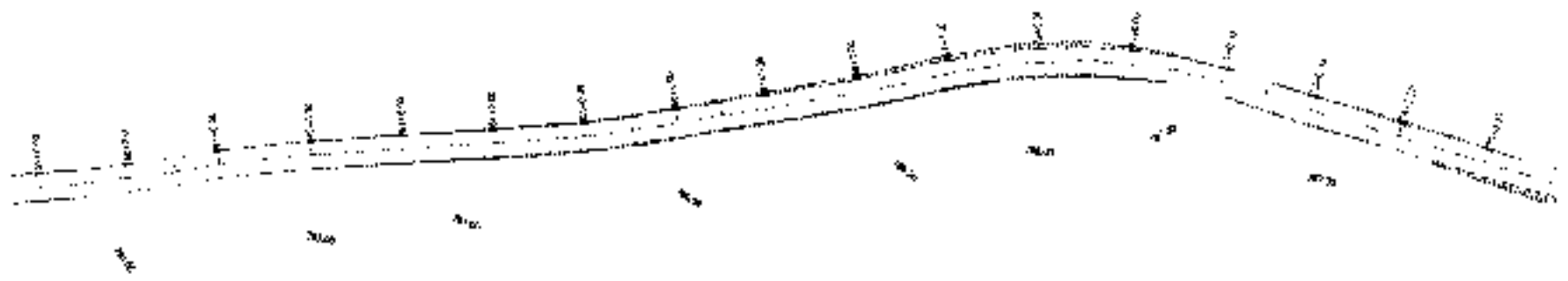

1:1000 2000

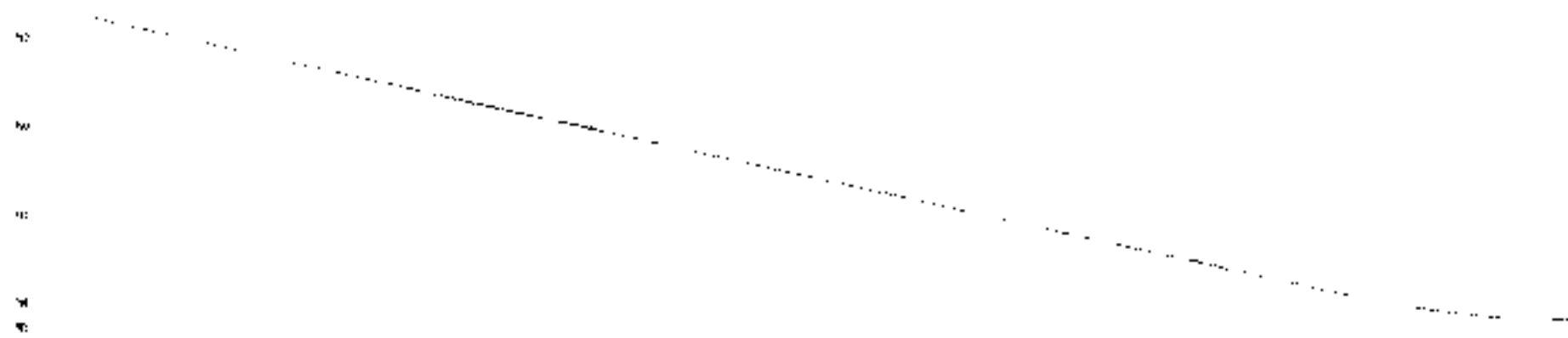

0+00	0+10	0+20	0+30	0+40	0+50	0+60	0+70	0+80	0+90	1+00
10	10	10	10	10	10	10	10	10	10	10
20	20	20	20	20	20	20	20	20	20	20
30	30	30	30	30	30	30	30	30	30	30
40	40	40	40	40	40	40	40	40	40	40
50	50	50	50	50	50	50	50	50	50	50

TUBO PLASTICO	ALCANTARA	LATERAL	BOTO	TALUZO	MURTO	CANTO	CORTA D'ÁGUA

	PREFEITURA MUNICIPAL DE GUARACIABA DO NORTE		16 / 40
	RECUPERAÇÃO DE ESTRADAS VICINAIS NO MUNICÍPIO DE GUARACIABA DO NORTE - CE - RT 1086270-02		
ESTAQUEAMENTO E PERFIL LONGITUDINAL			
ESCALA: 1:1000	DATA: 10/05/2011		1:1000
PROJETO: 1086270-02			



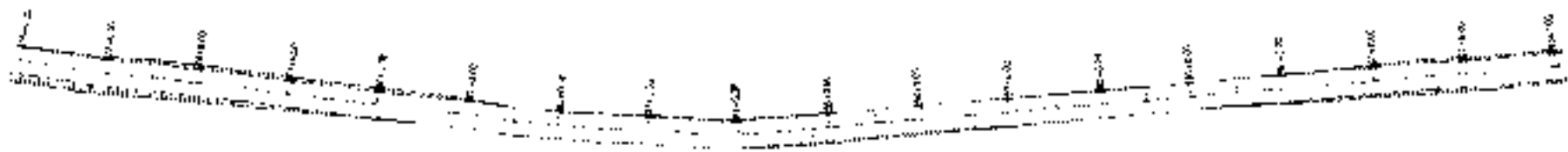

1:500 CAD

1	2	3	4	5	6	7	8	9	10	11	12	13	14	15	16	17	18
11.33	11.34	11.35	11.36	11.37	11.38	11.39	11.40	11.41	11.42	11.43	11.44	11.45	11.46	11.47	11.48	11.49	11.50
11.33	11.34	11.35	11.36	11.37	11.38	11.39	11.40	11.41	11.42	11.43	11.44	11.45	11.46	11.47	11.48	11.49	11.50
11.33	11.34	11.35	11.36	11.37	11.38	11.39	11.40	11.41	11.42	11.43	11.44	11.45	11.46	11.47	11.48	11.49	11.50



	PREFEITURA MUNICIPAL DE GUARACIABA DO NORTE		171
	RECUPERAÇÃO DE ESTRADAS MUNICIPAIS NO MUNICÍPIO DE GUARACIABA DO NORTE DE - PT 1385270-03		
ESTAQUEAMENTO E PERFIL LONGITUDINAL			
PROJETA	RUI CARLOS MOURA FERREIRA		
PROJETO	ESTRADA MUNICIPAL DE RUA - LONGETUDINAL - 1.000		

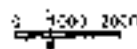
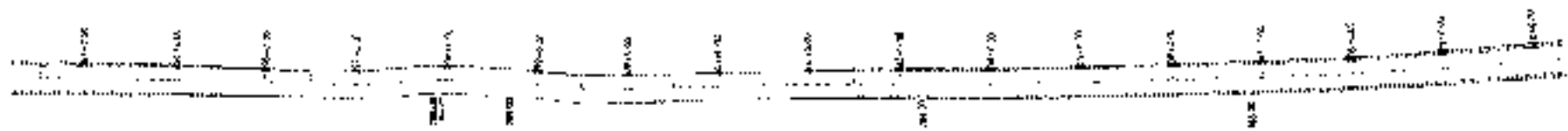

Estacão	0+00	0+10	0+20	0+30	0+40	0+50	0+60	0+70	0+80	0+90	1+00
Alt. (m)	10.00	10.50	11.00	11.50	12.00	12.50	13.00	13.50	14.00	14.50	15.00
Alt. (m)	10.00	10.50	11.00	11.50	12.00	12.50	13.00	13.50	14.00	14.50	15.00
Alt. (m)	10.00	10.50	11.00	11.50	12.00	12.50	13.00	13.50	14.00	14.50	15.00

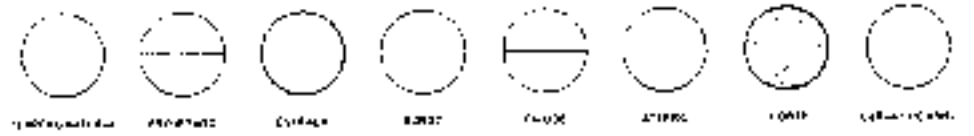

PREFEITURA MUNICIPAL DE GUARACIABA DO NORTE
RECUPERAÇÃO DE ESTRADAS VICINAIS NO MUNICÍPIO DE GUARACIABA DO NORTE-CE - PT 109627063
ESTAQUEAMENTO E PERFIL LONGITUDINAL

PROJETO: []
 ARQUIVO: []

18/11/2010
 11:00
 11:00

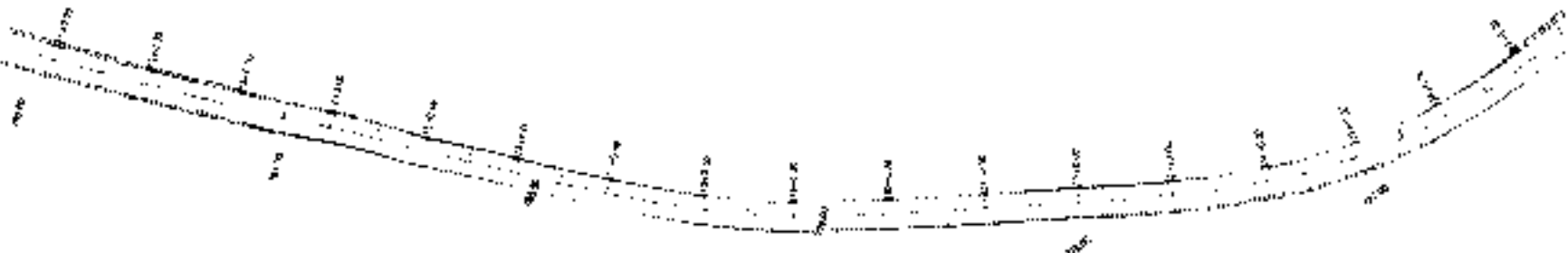

0 500 1000

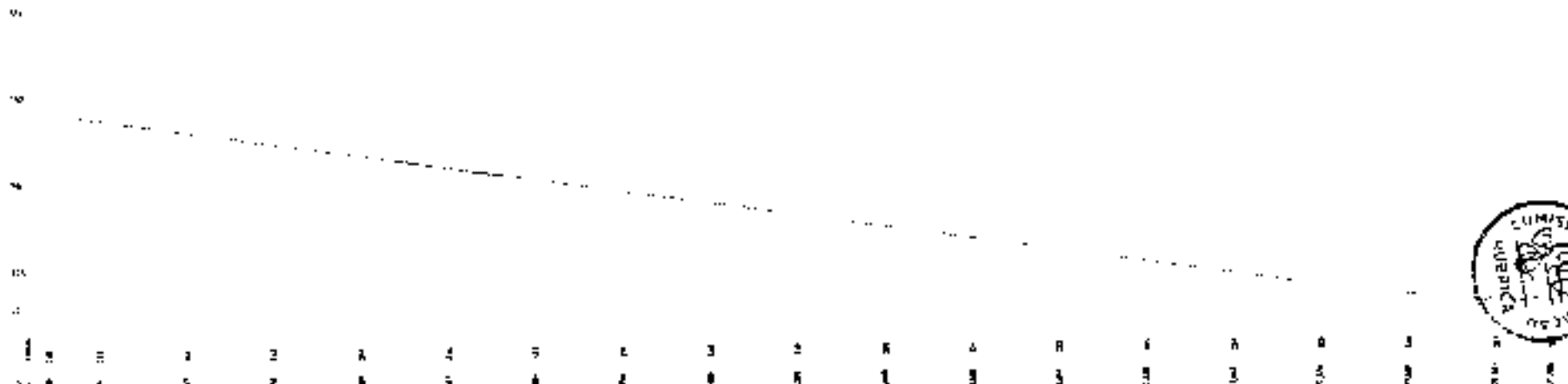

10	11	12	13	14	15	16	17	18	19	20	21	22	23	24	25	26	27	28	29	30	31	32	33	34	35	36	37	38	39	40	41	42	43	44	45	46	47	48	49	50	51	52	53	54	55	56	57	58	59	60	61	62	63	64	65	66	67	68	69	70	71	72	73	74	75	76	77	78	79	80	81	82	83	84	85	86	87	88	89	90	91	92	93	94	95	96	97	98	99	100
----	----	----	----	----	----	----	----	----	----	----	----	----	----	----	----	----	----	----	----	----	----	----	----	----	----	----	----	----	----	----	----	----	----	----	----	----	----	----	----	----	----	----	----	----	----	----	----	----	----	----	----	----	----	----	----	----	----	----	----	----	----	----	----	----	----	----	----	----	----	----	----	----	----	----	----	----	----	----	----	----	----	----	----	----	----	----	----	----	----	-----

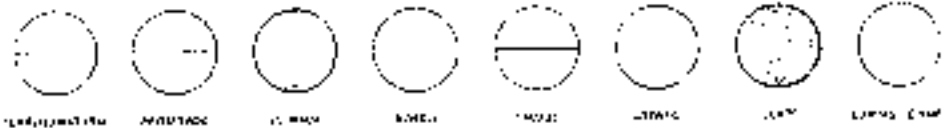

JOTA BARRAS
CONSULTORES

PREFEITURA MUNICIPAL DE GUARACIABA DO NORTE

RECUPERAÇÃO DE ESTRADAS VICINAIS NO MUNICÍPIO DE GUARACIABA DO NORTE-GE - PI 1086270/13

ESTAQUEAMENTO E PERFIL LONGITUDINAL

PROJETO: []

DATA: []

LOCAL: []

19 / 04

1:100



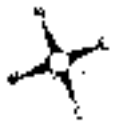

0 1000 2000

4
7
10
13
16

1	2	3	4	5	6	7	8	9	10	11	12	13	14	15	16	17	18	19	20
100	100	100	100	100	100	100	100	100	100	100	100	100	100	100	100	100	100	100	100
100	100	100	100	100	100	100	100	100	100	100	100	100	100	100	100	100	100	100	100
100	100	100	100	100	100	100	100	100	100	100	100	100	100	100	100	100	100	100	100

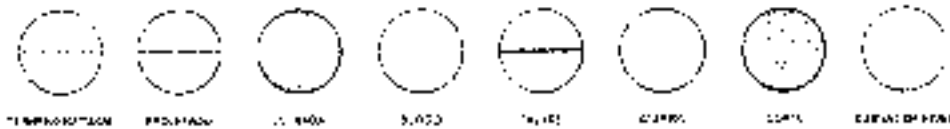

PREFEITURA MUNICIPAL DE GUARACABA DO NORTE
 RECUPERAÇÃO DE ESTRADAS VICINAIS NO MUNICÍPIO DE GUARACABA DO NORTE DE Nº 1066270-03
 ESTAQUEAMENTO E PERFIL LONGITUDINAL

PROPOSTA	UPR LINDA ESTRADEIRA RONDONIA - GUARACABA DO NORTE
PROJETO	PROJETO DE ESTAQUEAMENTO E PERFIL LONGITUDINAL



20/40
 12/10/2020
 10:00



1:2000 1000

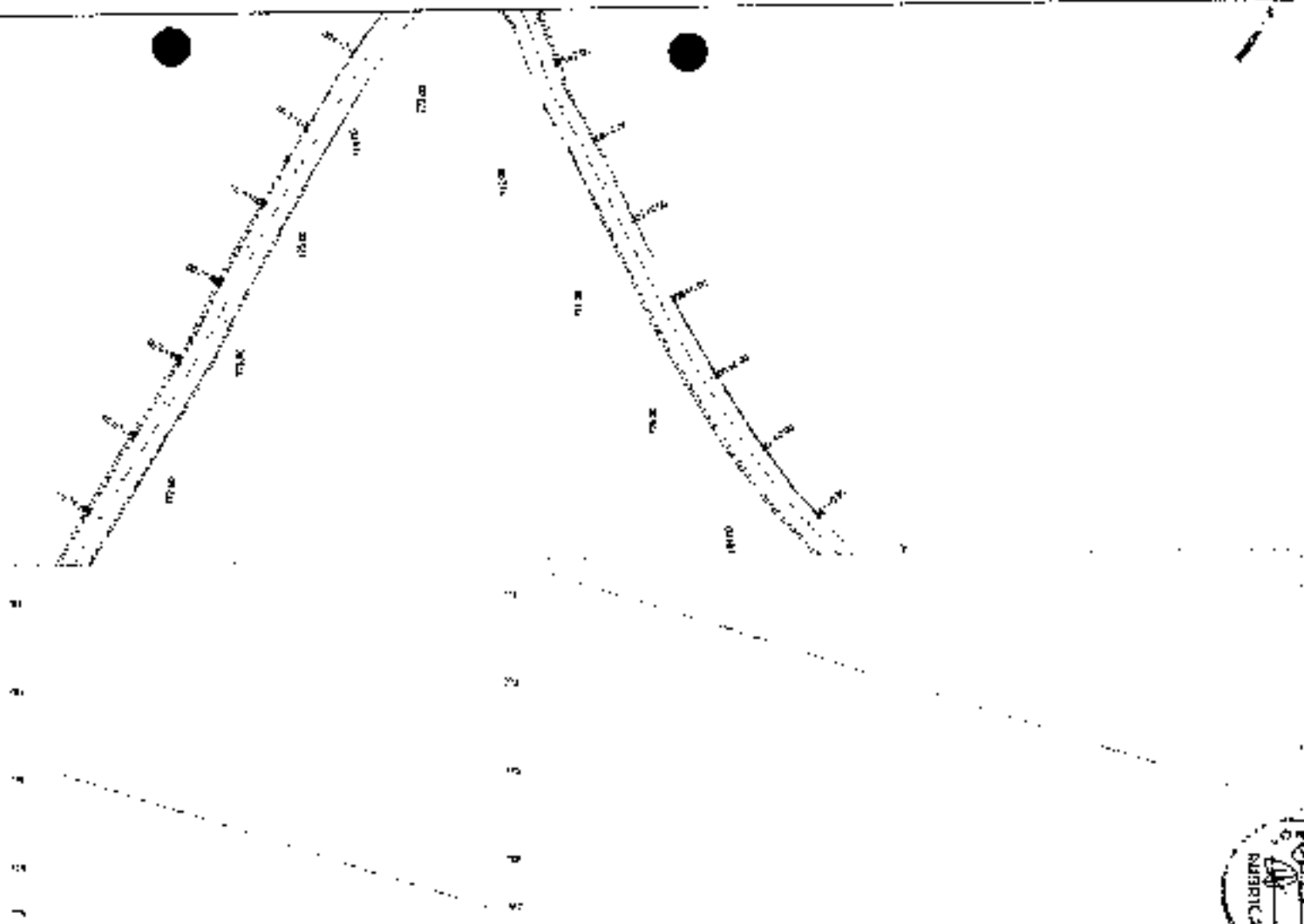

Estação	Alt. (m)	Gravidade (%)	Compr. (m)	Alt. (m)	Estação	Alt. (m)	Gravidade (%)	Compr. (m)	Alt. (m)	Estação	Alt. (m)	Gravidade (%)	Compr. (m)	Alt. (m)	Estação	Alt. (m)	Gravidade (%)	Compr. (m)	Alt. (m)
0+00	100.00	0.00	0.00	100.00	0+100	100.00	0.00	0.00	100.00	0+200	100.00	0.00	0.00	100.00	0+300	100.00	0.00	0.00	100.00



PREFEITURA MUNICIPAL DE GUARACIEMA DO NORTE
 RECUPERAÇÃO DE ESTRADAS VICINAIS NO MUNICÍPIO DE GUARACIEMA DO NORTE-CE - PI 1006270-03
ESTAQUEAMENTO E PERFIL LONGITUDINAL
 PROPOSTA: []
 RESUMO: []



21 / 40



1:200 20m

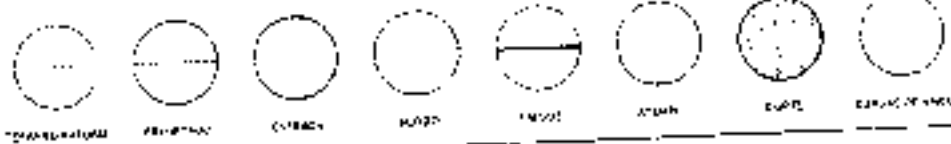
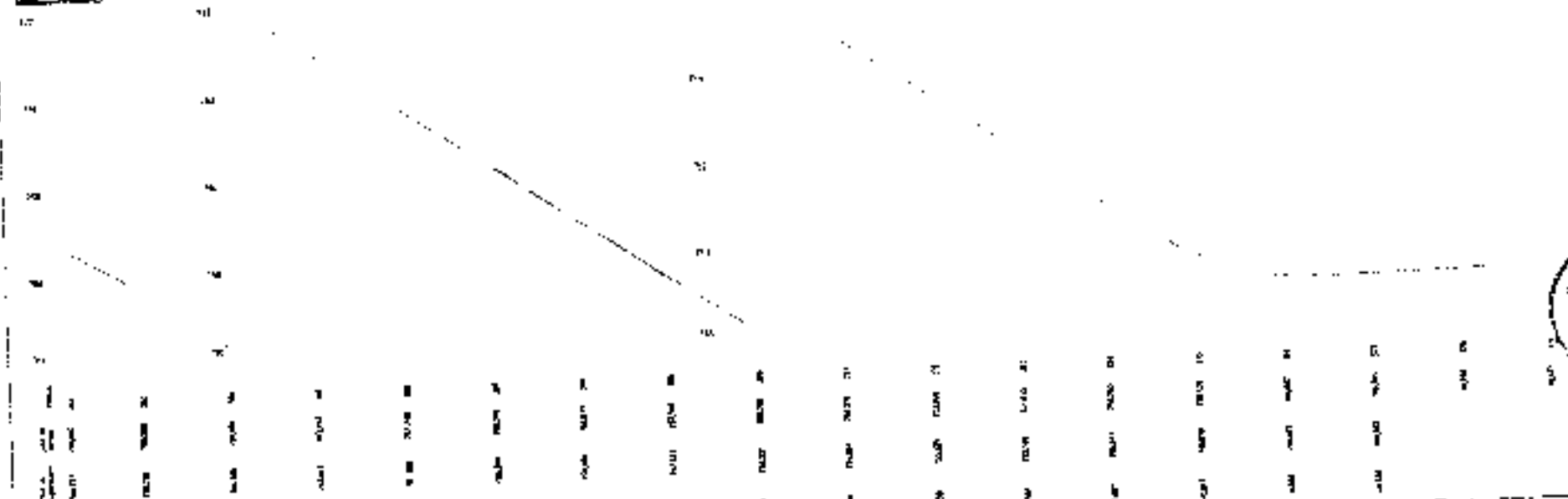

PREFEITURA MUNICIPAL DE GUARACABA DO NORTE
 RECUPERAÇÃO DE ESTRADAS VICINAIS NO MUNICÍPIO DE GUARACABA DO NORTE - PI 10627003
 ESTACQUEAMENTO E PERFIL LONGITUDINAL

22140
 PAVIMENTO
 H 1111000
 V 11110





1:2000 20.10

0
10
20
30
40
50

0+00	0+05	0+10	0+15	0+20	0+25	0+30	0+35	0+40	0+45	0+50
0+00	0+05	0+10	0+15	0+20	0+25	0+30	0+35	0+40	0+45	0+50
0+00	0+05	0+10	0+15	0+20	0+25	0+30	0+35	0+40	0+45	0+50
0+00	0+05	0+10	0+15	0+20	0+25	0+30	0+35	0+40	0+45	0+50



PREFEITURA MUNICIPAL DE GUARUJABA DO NORTE
 RECUPERAÇÃO DE ESTRADAS VICINAIS NO MUNICÍPIO DE GUARUJABA DO NORTE-UF - RJ - ORETOH03
 ESTAQUEAMENTO E PERFIL LONGITUDINAL

PROJETA	DR. VILMAR AGUIAR FERREIRA
ABOADA	ARQUITETO CARLOS FERREIRA DE SOUZA



23 / 40
 2010
 14/11/10

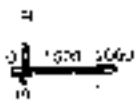

1	2	3	4	5	6	7	8	9	10	11	12	13	14	15	16	17	18	19	20
0+00	0+20	0+40	0+60	0+80	1+00	1+20	1+40	1+60	1+80	2+00	2+20	2+40	2+60	2+80	3+00	3+20	3+40	3+60	3+80
100	100	100	100	100	100	100	100	100	100	100	100	100	100	100	100	100	100	100	100
100	100	100	100	100	100	100	100	100	100	100	100	100	100	100	100	100	100	100	100



PREFEITURA MUNICIPAL DE GUARACABA DO NORTE
 RECUPERAÇÃO DE ESTRADAS VICINAIS NO MUNICÍPIO DE GUARACABA DO NORTE-CE - PT 1088276-03
 ESTAQUEAMENTO E PERFIL LONGITUDINAL



24 / 40
 ESCALA
 1:1000
 1/11/10

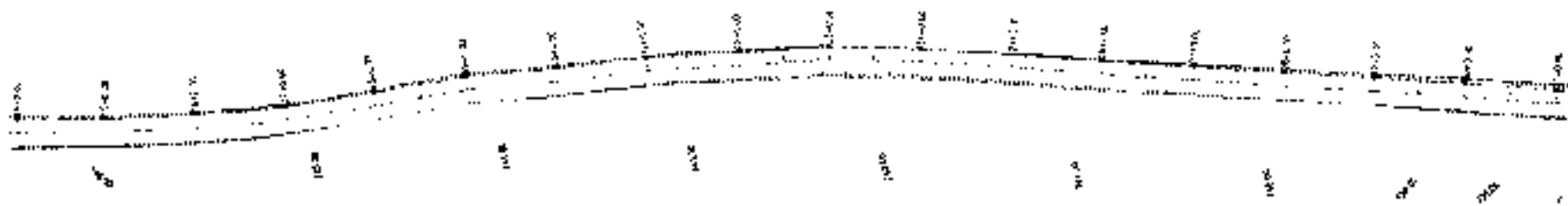

0 1000 2000

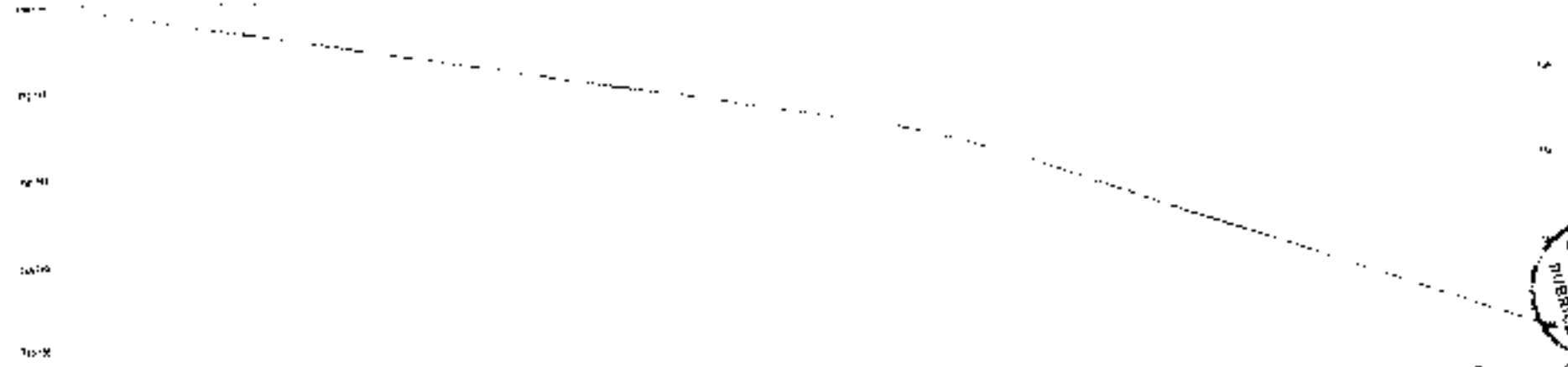

10	11	12	13	14	15	16	17	18	19	20	21	22	23	24	25	26	27	28	29	30
10	11	12	13	14	15	16	17	18	19	20	21	22	23	24	25	26	27	28	29	30
10	11	12	13	14	15	16	17	18	19	20	21	22	23	24	25	26	27	28	29	30
10	11	12	13	14	15	16	17	18	19	20	21	22	23	24	25	26	27	28	29	30



PREFEITURA MUNICIPAL DE GUARACIABA DO NORTE
 RECUPERAÇÃO DE ESTRADAS VICINAIS NO MUNICÍPIO DE GUARACIABA DO NORTE - CE - PT 108627003
 ESTAQUEAMENTO E PERFIL LONGITUDINAL

PROJETO: []
 LOCAL: []
 ESCALA: []

25/10

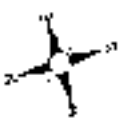

1:500 2000

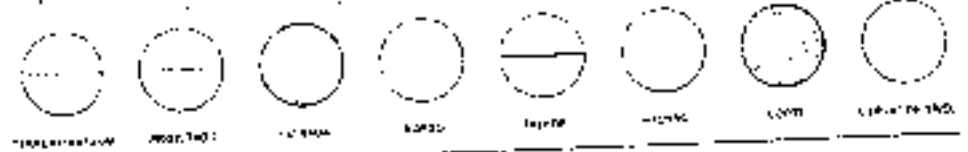
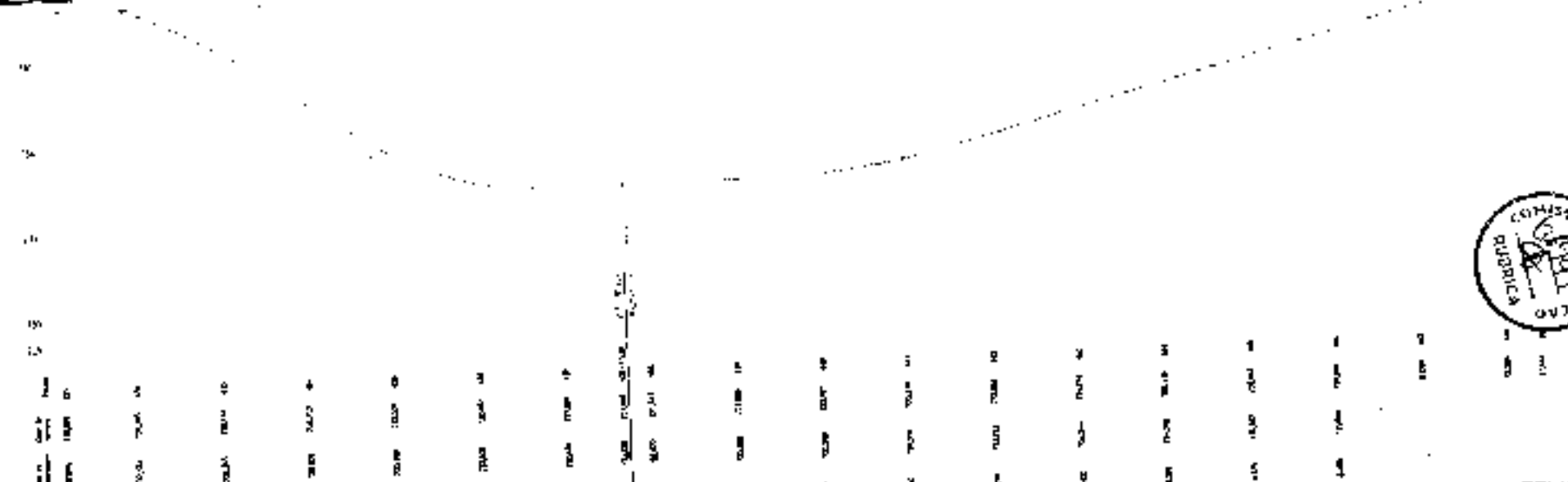

PREFEITURA MUNICIPAL DE GUARACIABA DO NORTE
 RECUPERAÇÃO DE ESTRADAS VICINAIS NO MUNICÍPIO DE GUARACIABA DO NORTE - CE - PT 10862/0-33
 ESTAQUEAMENTO E PERFIL LONGITUDINAL
 PROJETO DE RECUPERAÇÃO DE ESTRADAS VICINAIS
 ESTACIONAMENTO E PERFIL LONGITUDINAL

26 / 40
DATA: 11/11/13



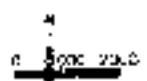
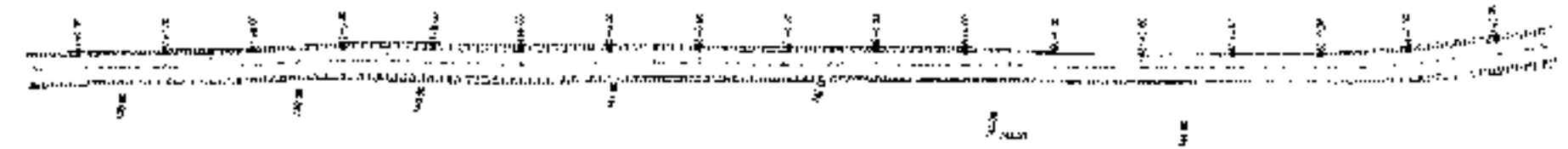
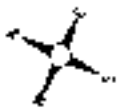

Est.	1	2	3	4	5	6	7	8	9	10	11	12	13	14	15	16	17	18	19	20
Alt. (m)	15.5	15.0	14.5	14.0	13.5	13.0	12.5	12.0	11.5	11.0	10.5	10.0	9.5	9.0	8.5	8.0	7.5	7.0	6.5	6.0
Proj. (m)	0	10	20	30	40	50	60	70	80	90	100	110	120	130	140	150	160	170	180	190

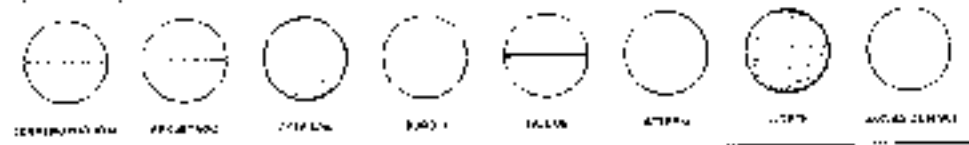

PREFEITURA MUNICIPAL DE GUARACIARA DO NORTE
 RECUPERAÇÃO DE ESTRADAS VICINAIS NO MUNICÍPIO DE GUARACIARA DO NORTE - CE - PT 1085270-03
 ESTAQUEAMENTO E PERFIL LONGITUDINAL
 PROJETO: []
 EXECUÇÃO: []
 ESCALA: []



27 / 40
 11/2012

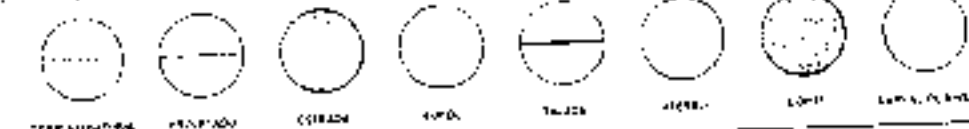
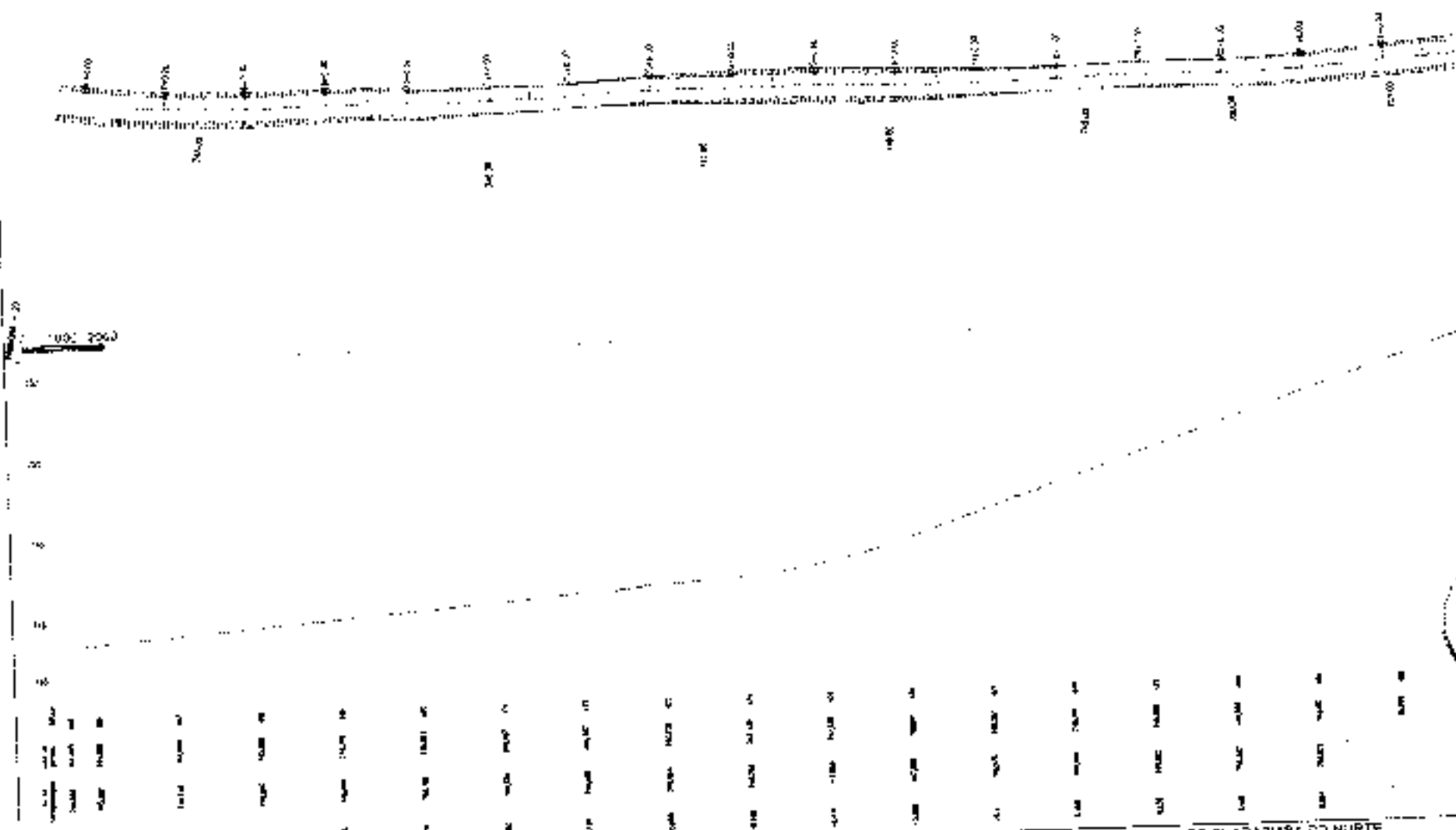

PREFEITURA MUNICIPAL DE GUARACIABA DO NORTE	
RECUPERAÇÃO DE ESTRADAS VICINAIS NO MUNICÍPIO DE GUARACIABA DO NORTE-CE - PT 1085/74-03	
ESTAQUEAMENTO E PERFIL LONGITUDINAL	
PROJETA	DIV. DE OBRAS E MANUTENÇÃO DE OBRAS PÚBLICAS
APROVADO	13/2012 IMPRETA LAY FARMILL + ESQUEMA DE PROJETO
MAPA Nº	28 / 40
FECHA	11/11/02
Nº	1116



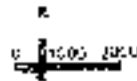
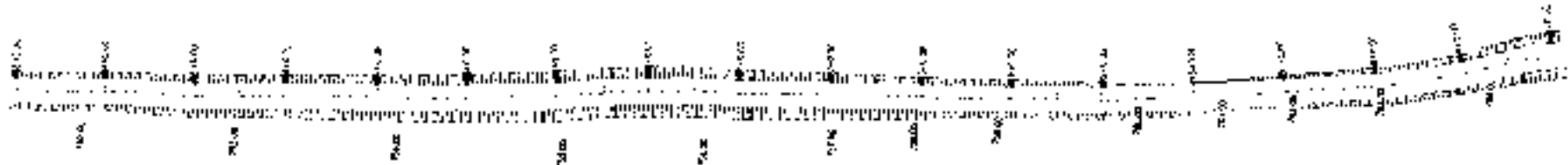

Estacão	0+00	0+20	0+40	0+60	0+80	1+00	1+20	1+40	1+60	1+80	2+00
Alt. (m)	100	105	110	115	120	125	130	135	140	145	150
Alt. Proj. (m)	100	105	110	115	120	125	130	135	140	145	150
Alt. (m)	100	105	110	115	120	125	130	135	140	145	150
Alt. Proj. (m)	100	105	110	115	120	125	130	135	140	145	150

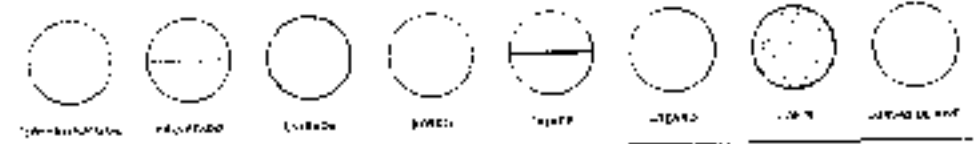

PREFEITURA MUNICIPAL DE GUARACABA DO NORTE

RECUPERAÇÃO DE ESTRADAS VICINAIS NO MUNICÍPIO DE GUARACABA DO NORTE-CE - OT 1036270-00

ESTACQUEAMENTO E PERFIL LONGITUDINAL

PROJETO: []
 ANEXO: []



29 / 0

11/0000

01/11/00

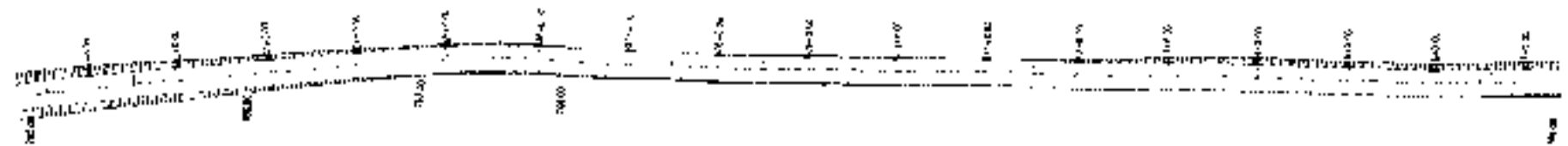

1:1000 A3000

10
5
0
-5
-10
-15
-20



0+00	0+10	0+20	0+30	0+40	0+50	0+60	0+70	0+80	0+90	1+00	1+10	1+20	1+30	1+40	1+50	1+60	1+70	1+80	1+90	2+00
0+00	0+10	0+20	0+30	0+40	0+50	0+60	0+70	0+80	0+90	1+00	1+10	1+20	1+30	1+40	1+50	1+60	1+70	1+80	1+90	2+00
0+00	0+10	0+20	0+30	0+40	0+50	0+60	0+70	0+80	0+90	1+00	1+10	1+20	1+30	1+40	1+50	1+60	1+70	1+80	1+90	2+00
0+00	0+10	0+20	0+30	0+40	0+50	0+60	0+70	0+80	0+90	1+00	1+10	1+20	1+30	1+40	1+50	1+60	1+70	1+80	1+90	2+00



CONCRETO, PAVIMENTO, CIMENTO, ASPHALTO, GRAVILHA, CIMENTO, CIMENTO, CIMENTO



PREFEITURA MUNICIPAL DE GUARACIABA DO NORTE
 REGENERAÇÃO DE ESTRADAS VICINAIS NO MUNICÍPIO DE GUARACIABA DO NORTE-CE - PT 1095270-03
 ESTACQUEAMENTO E PERFIL LONGITUDINAL

PROJETO: REGENERAÇÃO DE ESTRADAS VICINAIS NO MUNICÍPIO DE GUARACIABA DO NORTE-CE
 ARQUITETO: [Nome do Arquiteto]



30 / 40
02/04/2010
14:11:00

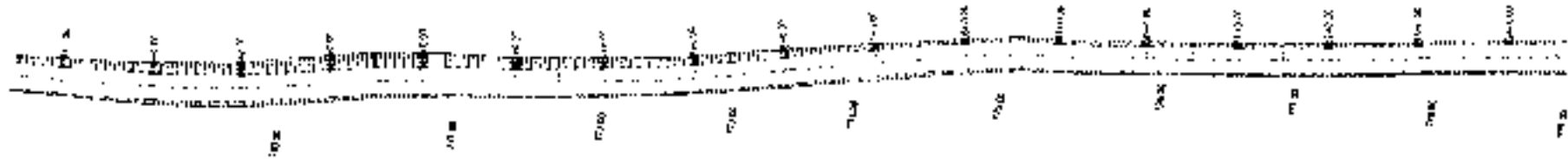
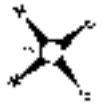

1:1000
10m



Estacão	0+00	0+10	0+20	0+30	0+40	0+50	0+60	0+70	0+80	0+90	1+00
Alt. Ex.	10.00	10.50	11.00	11.50	12.00	12.50	13.00	13.50	14.00	14.50	15.00
Alt. Proj.	10.00	10.50	11.00	11.50	12.00	12.50	13.00	13.50	14.00	14.50	15.00
Alt. Proj. (m)	10.00	10.50	11.00	11.50	12.00	12.50	13.00	13.50	14.00	14.50	15.00

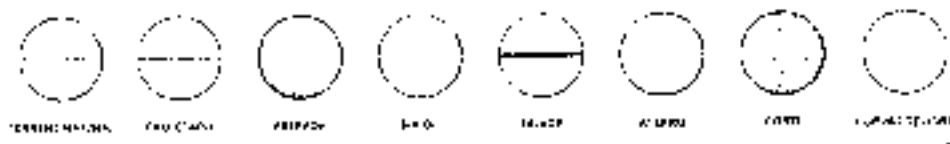

PREFEITURA MUNICIPAL DE GUARACIABA DO NORTE

RECUPERAÇÃO DE ESTRADAS VILANAS NO MUNICÍPIO DE GUARACIABA DO NORTE-CE - PT 1088270-03

ESTACQUEAMENTO E PERFIL LONGITUDINAL

PROJETO: DR. CARLOS EDUARDO MOURA LIMA - CARLOS EDUARDO MOURA LIMA

DATA: 10/05/2011

31/40

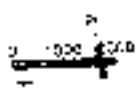
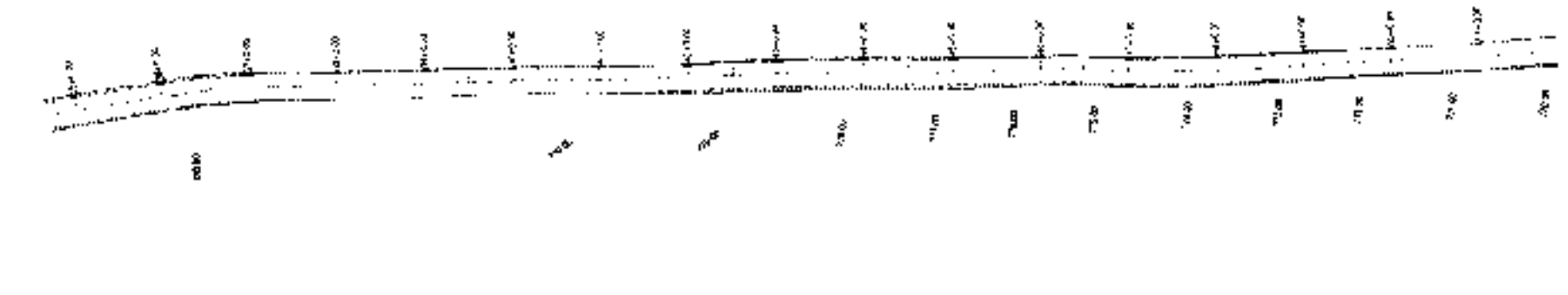

Estação	0+00	0+20	0+40	0+60	0+80	1+00	1+20	1+40	1+60	1+80	2+00
Alt. (m)	100.00	100.00	100.00	100.00	100.00	100.00	100.00	100.00	100.00	100.00	100.00
Alt. (m)	100.00	100.00	100.00	100.00	100.00	100.00	100.00	100.00	100.00	100.00	100.00
Alt. (m)	100.00	100.00	100.00	100.00	100.00	100.00	100.00	100.00	100.00	100.00	100.00
Alt. (m)	100.00	100.00	100.00	100.00	100.00	100.00	100.00	100.00	100.00	100.00	100.00
Alt. (m)	100.00	100.00	100.00	100.00	100.00	100.00	100.00	100.00	100.00	100.00	100.00
Alt. (m)	100.00	100.00	100.00	100.00	100.00	100.00	100.00	100.00	100.00	100.00	100.00
Alt. (m)	100.00	100.00	100.00	100.00	100.00	100.00	100.00	100.00	100.00	100.00	100.00
Alt. (m)	100.00	100.00	100.00	100.00	100.00	100.00	100.00	100.00	100.00	100.00	100.00
Alt. (m)	100.00	100.00	100.00	100.00	100.00	100.00	100.00	100.00	100.00	100.00	100.00
Alt. (m)	100.00	100.00	100.00	100.00	100.00	100.00	100.00	100.00	100.00	100.00	100.00



 JOSA LEMOS ENGENHARIA	PREFEITURA MUNICIPAL DE GUARACIABA DO NORTE RECUPERAÇÃO DE ESTRADAS VIARIAS NO MUNICÍPIO DE GUARACIABA DO NORTE-CE - PT 1005276-03		32 / 40
	ESTAQUEAMENTO E PERFIL LONGITUDINAL		1005276-03
PROJETO:	PROJETO DE RECUPERAÇÃO DE ESTRADAS VIARIAS		1005276-03
DATA:	10/05/2010		1005276-03

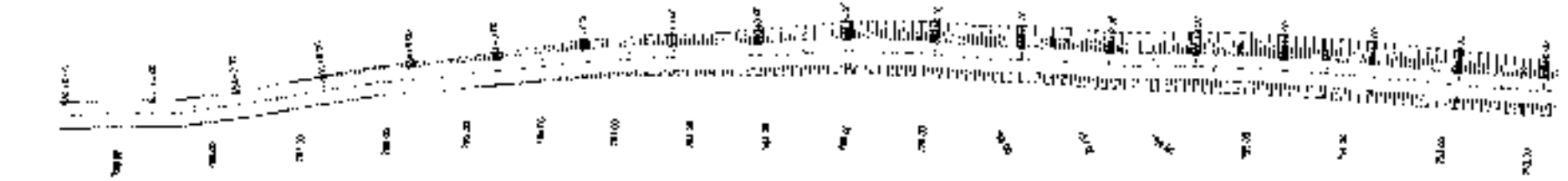
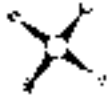

1:2000

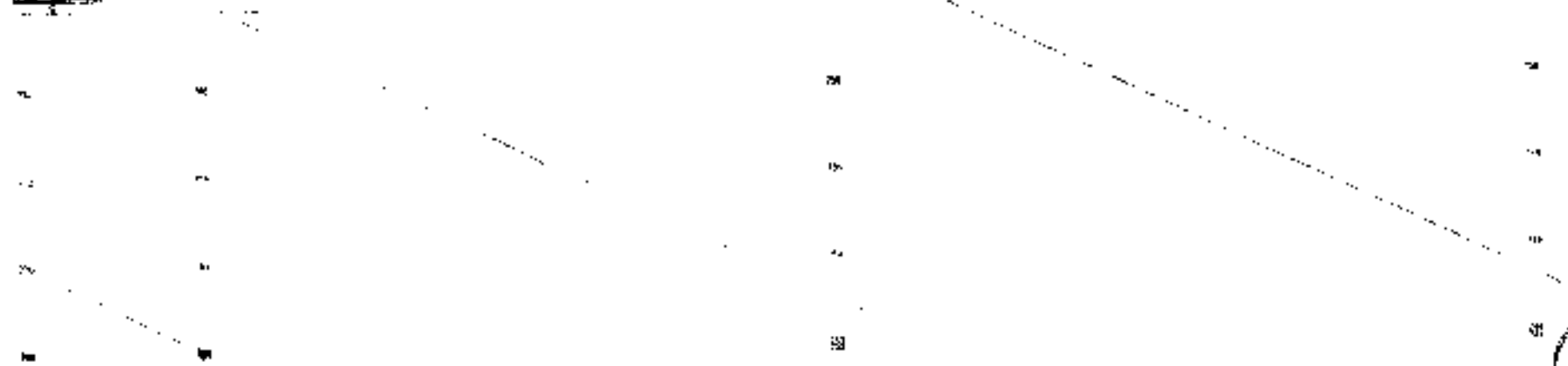

0+00	0+10	0+20	0+30	0+40	0+50	0+60	0+70	0+80	0+90	0+100	0+110	0+120	0+130	0+140	0+150	0+160	0+170	0+180	0+190	0+200
------	------	------	------	------	------	------	------	------	------	-------	-------	-------	-------	-------	-------	-------	-------	-------	-------	-------

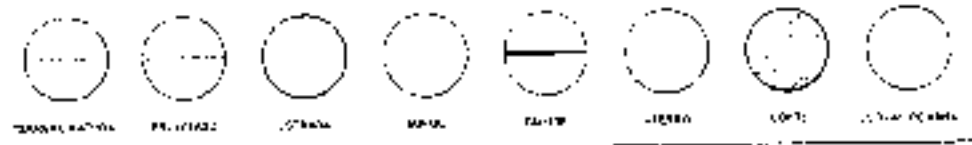

PREFEITURA MUNICIPAL DE GUARACIABA DO NORTE
 RECUPERAÇÃO DE ESTRADAS VICINAIS NO MUNICÍPIO DE GUARACIABA DO NORTE-CE - P.I. 1006270-03
 ESTACQUEAMENTO E PERFIL LONGITUDINAL

PROJETO: DR. ENG. CIVIL MARIO AUGUSTO DE SOUZA
 LOCAL: RUA JOSÉ DE SOUZA, S/N, BARRIO DE SÃO CARLOS

33 / 40
 11/10/2008

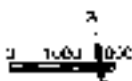

0+00	0+05	0+10	0+15	0+20	0+25	0+30	0+35	0+40	0+45	0+50	0+55	0+60	0+65	0+70	0+75	0+80	0+85	0+90	0+95	1+00
------	------	------	------	------	------	------	------	------	------	------	------	------	------	------	------	------	------	------	------	------

MANHOLE	CURB	GUTTER	SLOPE	DRAINAGE	DRAINAGE	DRAINAGE	DRAINAGE



PREFEITURA MUNICIPAL DE GUARACIABA DO NORTE
 RECUPERAÇÃO DE ESTRADAS VICINAIS NO MUNICÍPIO DE GUARACIABA DO NORTE-CE - PT 108270-03
 ESTACAMENTO E PERFIL LONGITUDINAL

PROJETO	100% DE PROJETO EXECUTIVO
EMPRESA	JOTA BARROS PEREIRA



34 / 40
 DATA: 11/02/2018

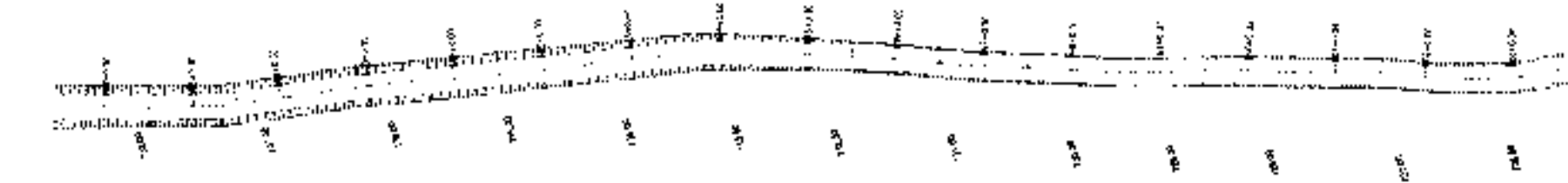

1:1000



Estacão	Alt. Ex.	Alt. Proj.	Alt. Ex.	Alt. Proj.	Alt. Ex.	Alt. Proj.	Alt. Ex.	Alt. Proj.	Alt. Ex.	Alt. Proj.	Alt. Ex.	Alt. Proj.	Alt. Ex.	Alt. Proj.	Alt. Ex.	Alt. Proj.	Alt. Ex.	Alt. Proj.
10+00	105.00	105.00	105.00	105.00	105.00	105.00	105.00	105.00	105.00	105.00	105.00	105.00	105.00	105.00	105.00	105.00	105.00	105.00
10+20	105.50	105.50	105.50	105.50	105.50	105.50	105.50	105.50	105.50	105.50	105.50	105.50	105.50	105.50	105.50	105.50	105.50	105.50
10+40	106.00	106.00	106.00	106.00	106.00	106.00	106.00	106.00	106.00	106.00	106.00	106.00	106.00	106.00	106.00	106.00	106.00	106.00
10+60	106.50	106.50	106.50	106.50	106.50	106.50	106.50	106.50	106.50	106.50	106.50	106.50	106.50	106.50	106.50	106.50	106.50	106.50
10+80	107.00	107.00	107.00	107.00	107.00	107.00	107.00	107.00	107.00	107.00	107.00	107.00	107.00	107.00	107.00	107.00	107.00	107.00
11+00	107.50	107.50	107.50	107.50	107.50	107.50	107.50	107.50	107.50	107.50	107.50	107.50	107.50	107.50	107.50	107.50	107.50	107.50
11+20	108.00	108.00	108.00	108.00	108.00	108.00	108.00	108.00	108.00	108.00	108.00	108.00	108.00	108.00	108.00	108.00	108.00	108.00
11+40	108.50	108.50	108.50	108.50	108.50	108.50	108.50	108.50	108.50	108.50	108.50	108.50	108.50	108.50	108.50	108.50	108.50	108.50
11+60	109.00	109.00	109.00	109.00	109.00	109.00	109.00	109.00	109.00	109.00	109.00	109.00	109.00	109.00	109.00	109.00	109.00	109.00
11+80	109.50	109.50	109.50	109.50	109.50	109.50	109.50	109.50	109.50	109.50	109.50	109.50	109.50	109.50	109.50	109.50	109.50	109.50
12+00	110.00	110.00	110.00	110.00	110.00	110.00	110.00	110.00	110.00	110.00	110.00	110.00	110.00	110.00	110.00	110.00	110.00	110.00

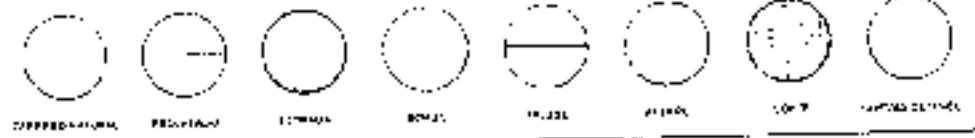

PREFEITURA MUNICIPAL DE GUARACIABA DO NORTE
 RECUPERAÇÃO DE ESTRADAS VICINAIS NO MUNICÍPIO DE GUARACIABA DO NORTE-CE - PT 108270-00
 ESTACQUEAMENTO E PERFIL LONGITUDINAL
 PROJETO: []
 DATA: []



35 / 40
 DATA: []
 HORA: []
 LOCAL: []

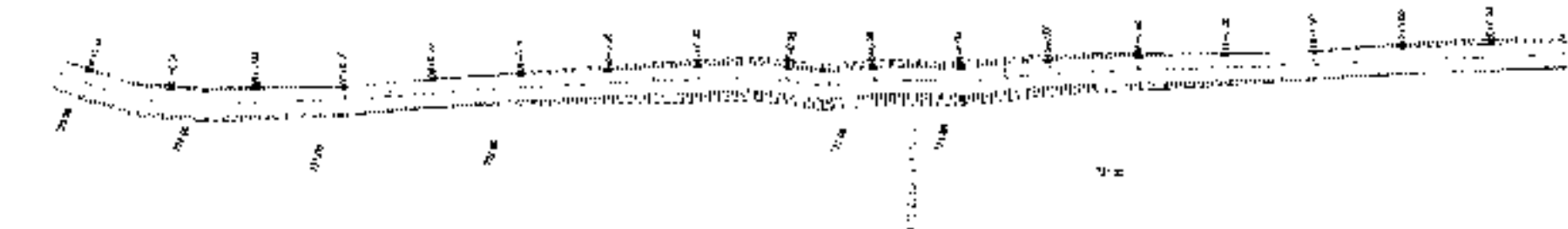

1:1000 2000

0+00
0+20
0+40
0+60
0+80
1+00

EST. 1
EST. 2
EST. 3
EST. 4
EST. 5
EST. 6
EST. 7
EST. 8

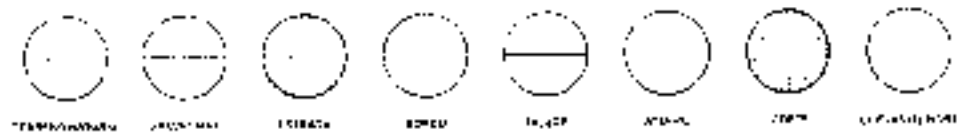

1:1000 2000

EST. 9
EST. 10
EST. 11
EST. 12
EST. 13
EST. 14
EST. 15
EST. 16



PREFEITURA MUNICIPAL DE GUARACIABA DO NORTE
 RECUPERAÇÃO DE ESTRADAS VICINAIS NO MUNICÍPIO DE GUARACIABA DO NORTE, CE - PT 1086270-03
 ESTAQUEAMENTO E PERFIL LONGITUDINAL

PROJETO DE ARRAZAMENTO E BARRAS DE CORTA E BORDO
 ELABORADO POR: JOTA BARRAS



36 / 42
1:1000
1:1000



Estação	0+00	0+10	0+20	0+30	0+40	0+50	0+60	0+70	0+80	0+90	1+00
Alt. Terreno	10,5	11,5	12,5	13,5	14,5	15,5	16,5	17,5	18,5	19,5	20,5
Alt. Projeto	10,5	11,5	12,5	13,5	14,5	15,5	16,5	17,5	18,5	19,5	20,5
Alt. Pavim.	10,5	11,5	12,5	13,5	14,5	15,5	16,5	17,5	18,5	19,5	20,5



PREFEITURA MUNICIPAL DE GUARACIABA DO NORTE
 RECUPERAÇÃO DE ESTRADAS VICINAIS NO MUNICÍPIO DE GUARACIABA DO NORTE-CE - PT 1386270-03
 ESTAQUEAMENTO E PERFIL LONGITUDINAL
 PROPOSTA: ENG. JOTA BARROS ENGENHARIA E ARQUITETURA
 RUA SCS, 100 - JARDIM DE SÃO DOMINGOS - RECIFE - PE
 51.100-000



38 / 42
 Escala: 1:100
 15/08/2023

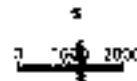
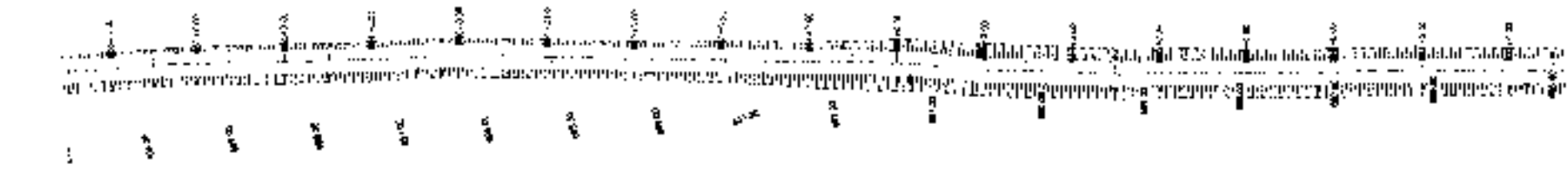
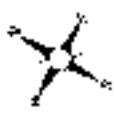

1	2	3	4	5	6	7	8	9	10	11	12	13	14	15	16	17	18	19	20
1	2	3	4	5	6	7	8	9	10	11	12	13	14	15	16	17	18	19	20
1	2	3	4	5	6	7	8	9	10	11	12	13	14	15	16	17	18	19	20
1	2	3	4	5	6	7	8	9	10	11	12	13	14	15	16	17	18	19	20

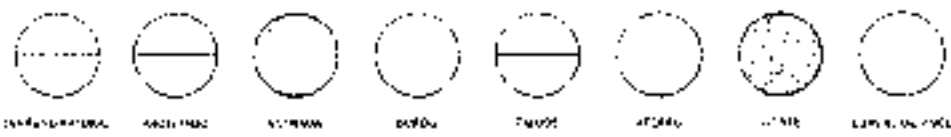

PREFEITURA MUNICIPAL DE GUARACIABA DO NORTE
 RECUPERAÇÃO DE ESTRADAS VICINAIS NO MUNICÍPIO DE GUARACIABA DO NORTE-CE - FT. 1066273-03
 ESTAKEAMENTO E PERFIL LONGITUDINAL

PROJETA	PROF. DR. ARNALDO BORGES LIMA JUNIOR
PROJ. ARQ.	LEI. DE GUARACIABA DO NORTE - CE, LEI. Nº 1066273-03

39 / 40



0 1000 2000

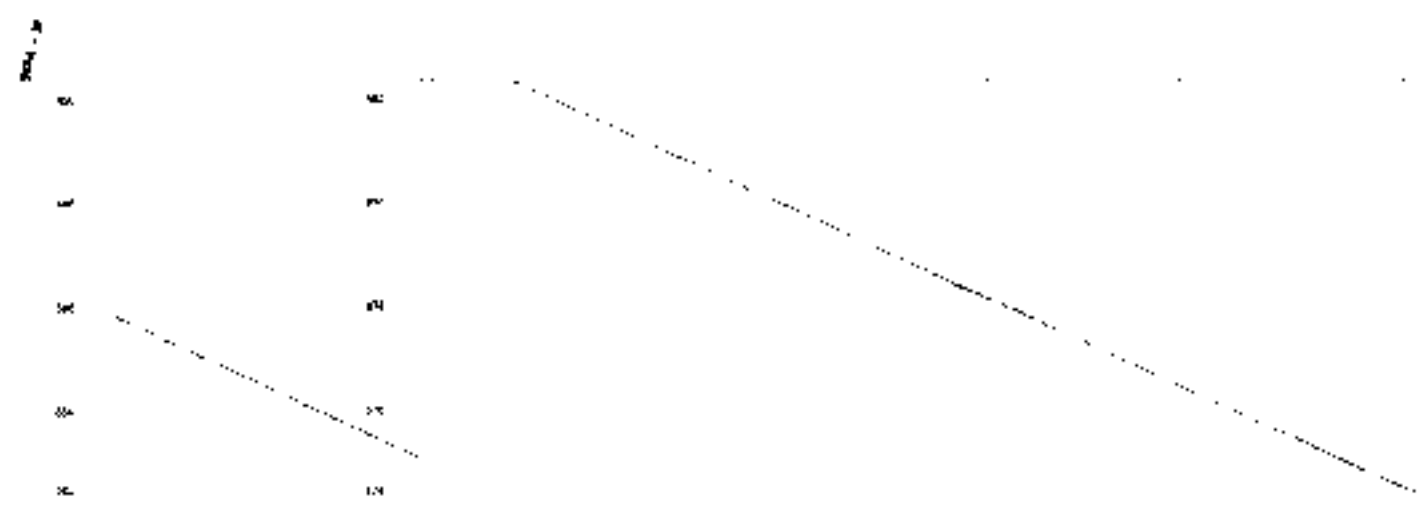

Estacão	0+00	0+10	0+20	0+30	0+40	0+50	0+60	0+70	0+80	0+90	1+00
Alt. Proj.	12.00	11.80	11.60	11.40	11.20	11.00	10.80	10.60	10.40	10.20	10.00
Alt. Ter.	12.00	11.80	11.60	11.40	11.20	11.00	10.80	10.60	10.40	10.20	10.00
Alt. Proj. (m)	12.00	11.80	11.60	11.40	11.20	11.00	10.80	10.60	10.40	10.20	10.00
Alt. Ter. (m)	12.00	11.80	11.60	11.40	11.20	11.00	10.80	10.60	10.40	10.20	10.00

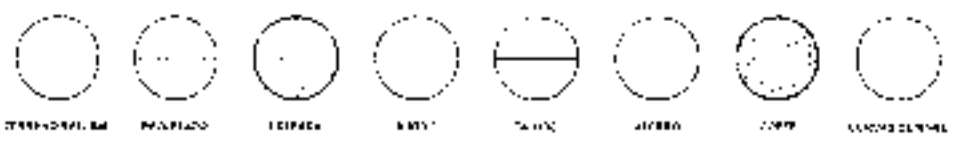



PREFEITURA MUNICIPAL DE GUARACIABA DO NORTE

RECUPERAÇÃO DE ESTRADAS VICINAS NO MUNICÍPIO DE GUARACIABA DO NORTE-CE - AT 10852/001

ESTAQUEAMENTO E PERFIL LONGITUDINAL

PROJETO: ENG.º JOSÉ CARLOS DE ALMEIDA PEREIRA JUNIOR

REVISÃO: 1 - 20/08/2010 - 10852/001

055

GUERREIRA

LEGENDA

AERRO
CURTE



PREFEITURA MUNICIPAL DE GUARACABA DO NORTE
RECLPERAÇÃO DE ESTRADAS VIZINAIS NO MUNICIPIO DE GUARACIARA
DO NORTE-CE - PT - 085210-03
SEÇÃO TRANSVERSAL



PROJETO DE
RECLPERAÇÃO DE ESTRADAS VIZINAIS

177

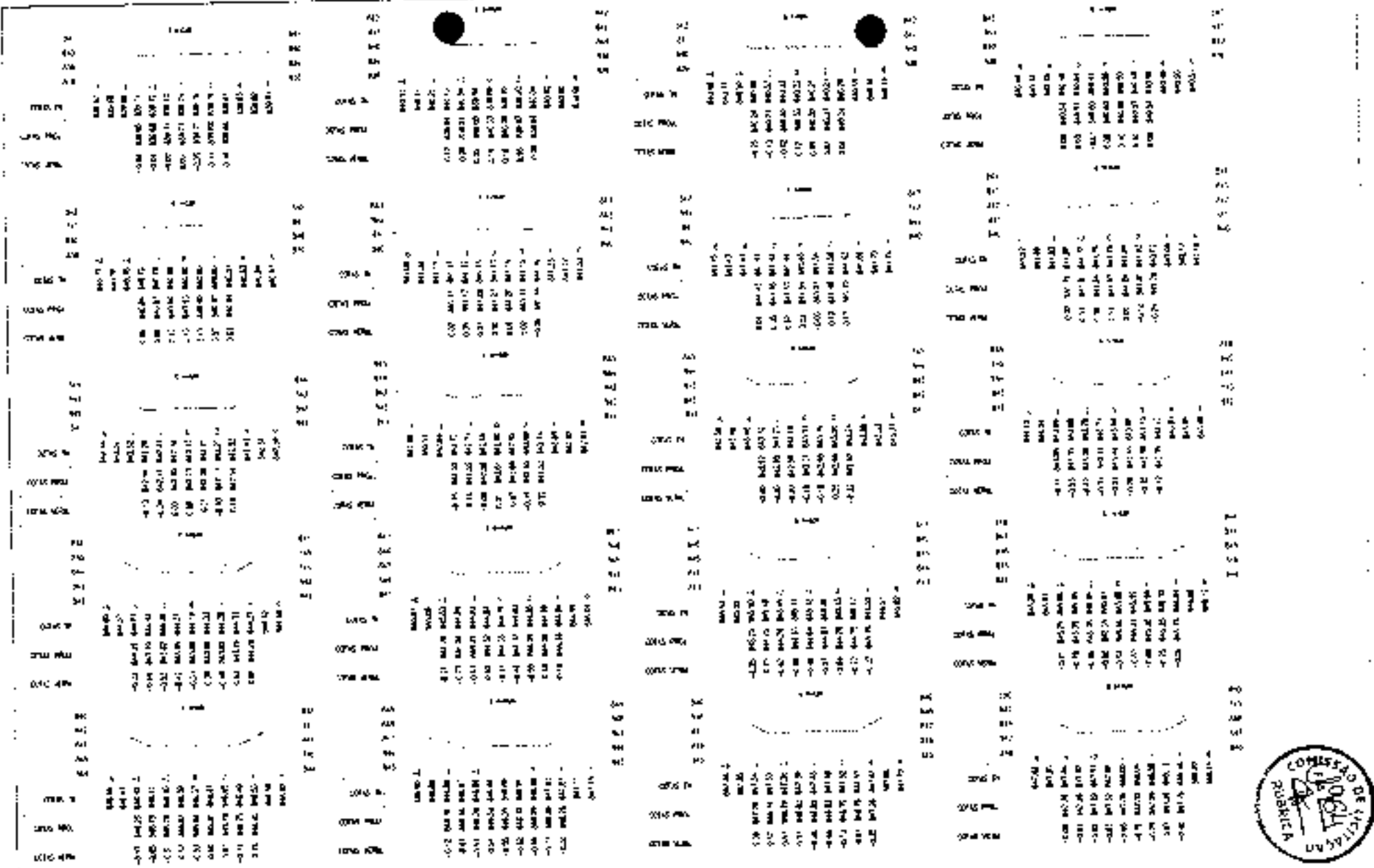
1982



LEGENDA

-  ATERRO
-  CORTE

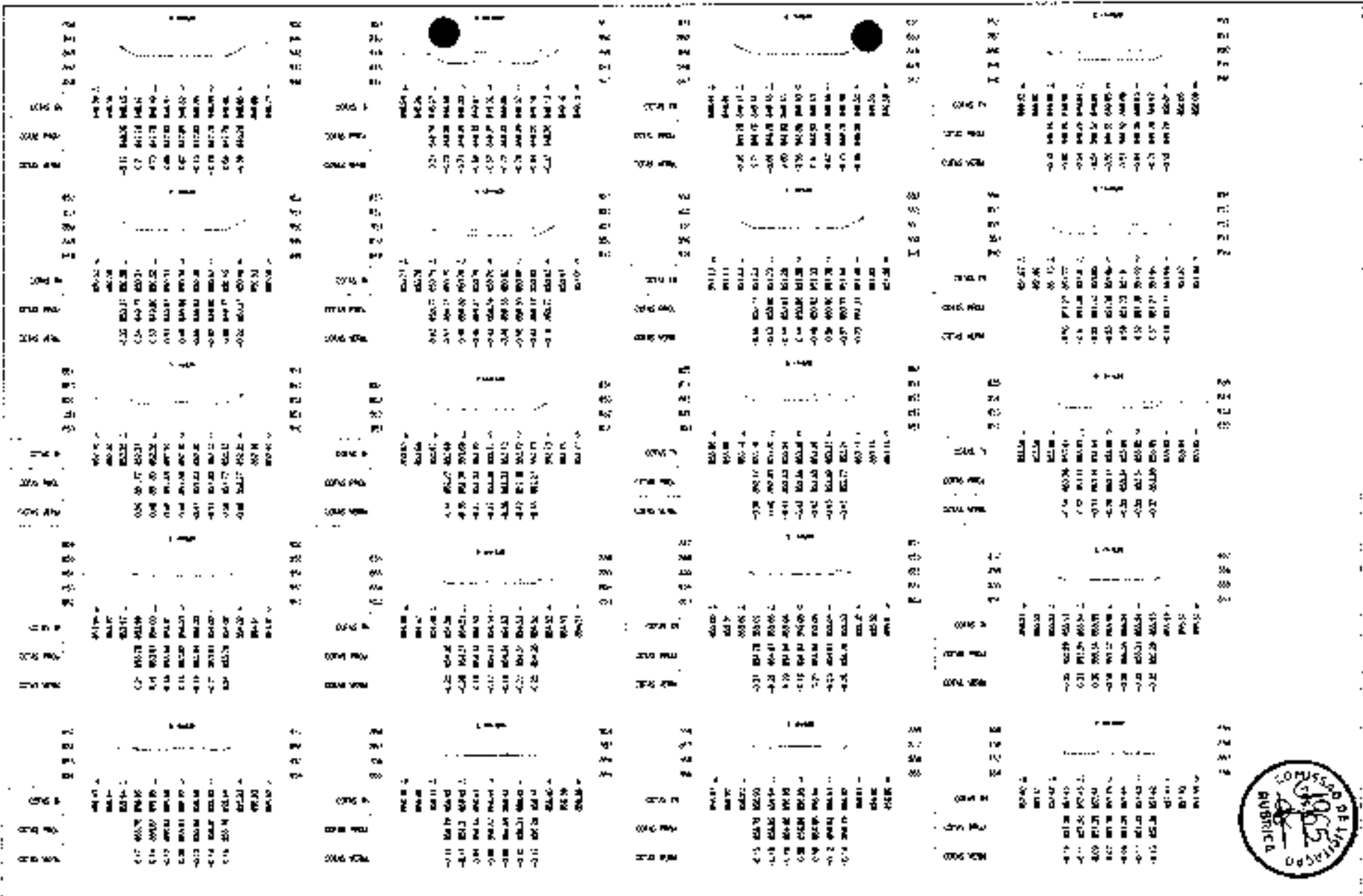

	PREFEITURA MUNICIPAL DE GUARAJABA DO NORTE RECUPERAÇÃO DE ESTRADAS VICINAIS NO MUNICÍPIO DE GUARAJABA DO NORTE-DE-PI (008270603)		Nº 2 / 72
	SEÇÕES TRANSVERSAIS		
	PROJETO: _____	ESCALA: _____	DATA: _____





PREFEITURA MUNICIPAL DE GUARACIARA DO NORTE
 REGISTRAÇÃO DE ESTRAÇAS VICINAIS NO MUNICÍPIO DE GUARACIARA DO NORTE - SC - PT 1086270-03
 SEÇÕES TRANSVERSAIS

3 / 73

PROJ. DEB. Nº 004/2014 - 1ª FASE - 1ª ETAPA - 1ª SUB-ETAPA
 PROJ. DEB. Nº 004/2014 - 1ª FASE - 1ª ETAPA - 1ª SUB-ETAPA



LEGENDA

	ATEHNC
	COME

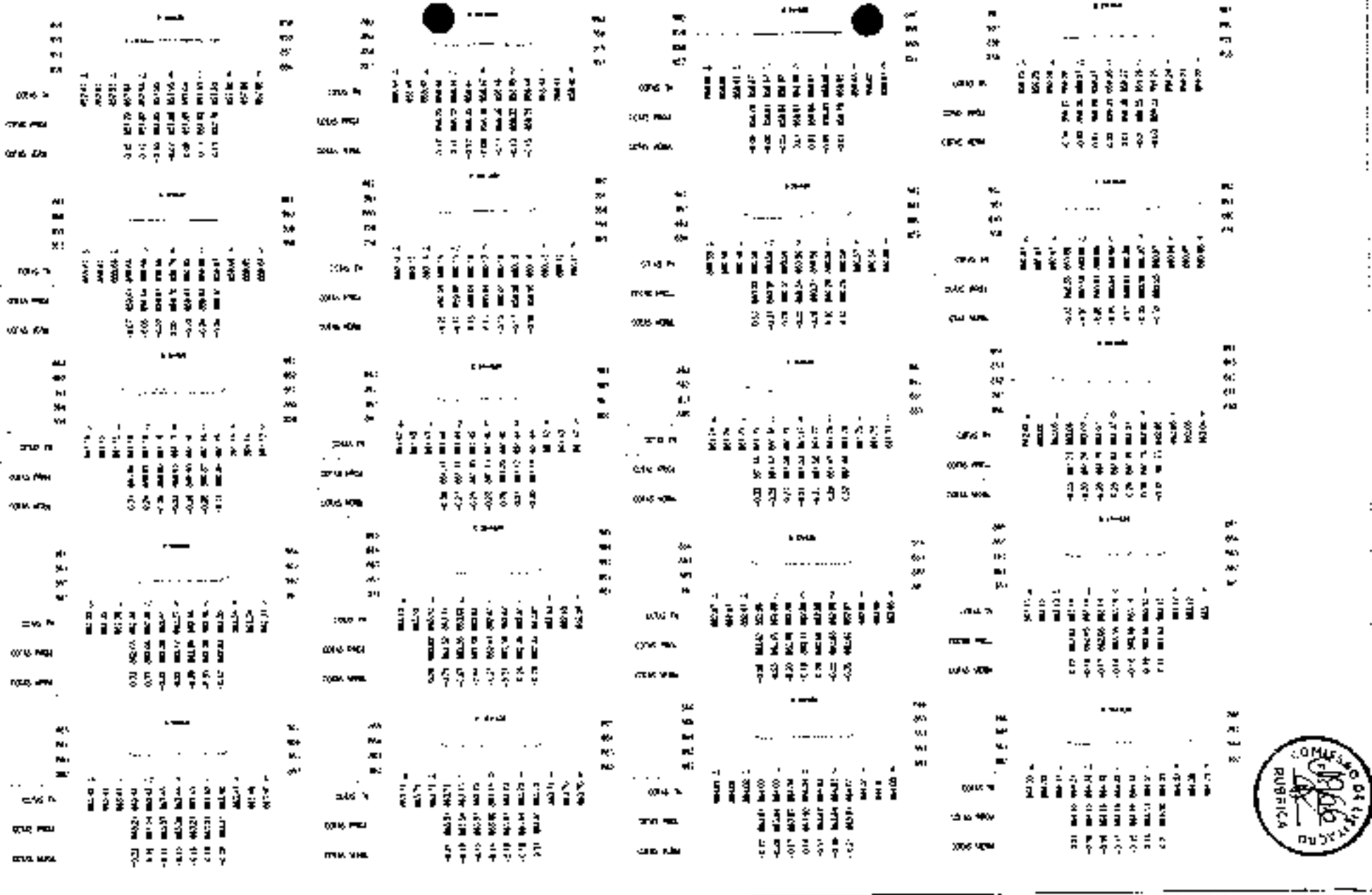

LEGENDA

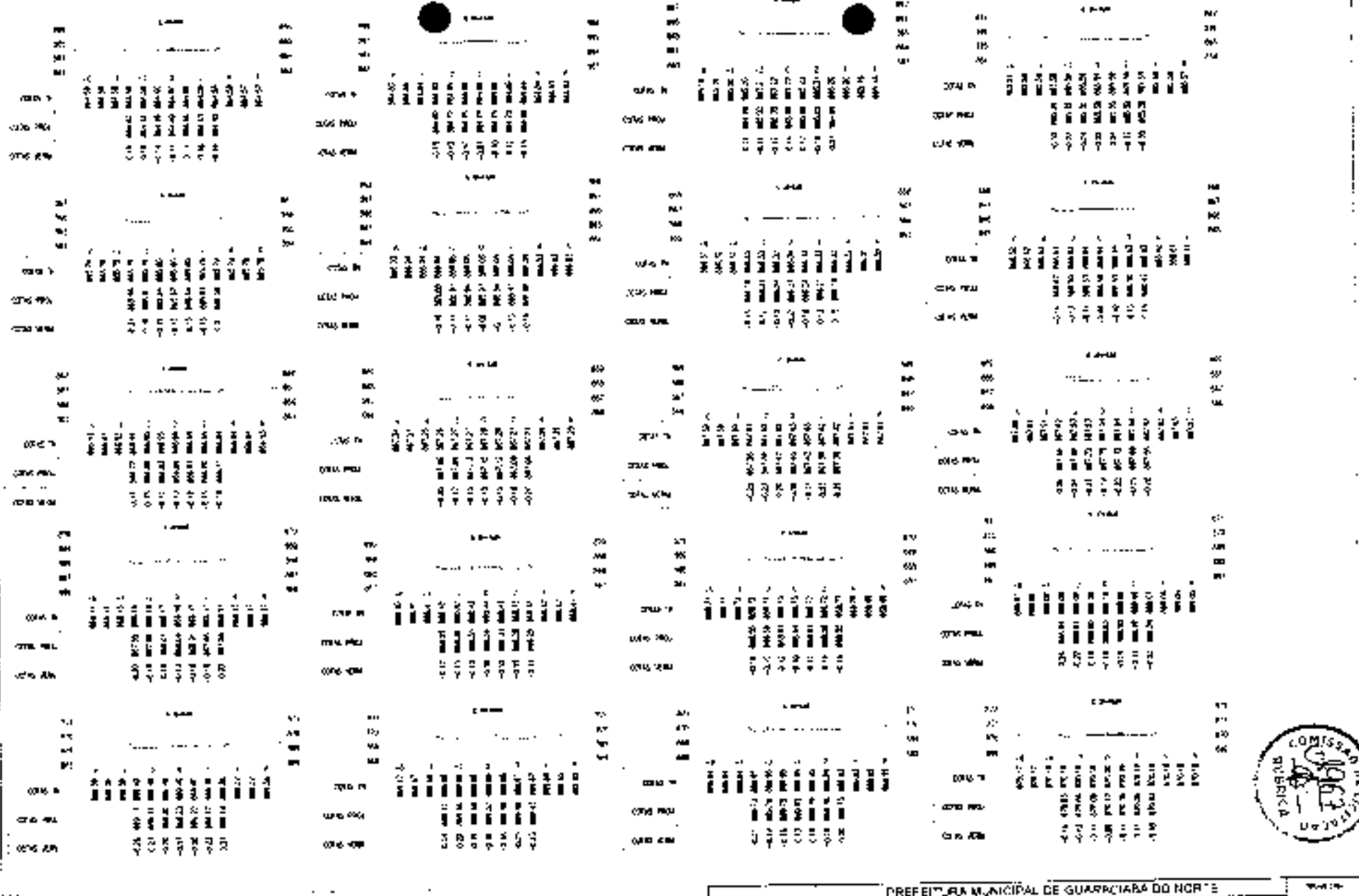

 <p>JOTA BARROS ENGENHARIA</p>	PREFEITURA MUNICIPAL DE GUARACIABA DO NORTE RECUPERAÇÃO DE ESTRADAS VICINAIS NO MUNICÍPIO DE GUARACIABA DO NORTE CE - RT 1066270-00		473
	SEÇÕES TRANSVERSAIS		
	Projeto: RT 1066270-00 Execução:	Rua:	



Item	Descrição	Valor	Item	Descrição	Valor	Item	Descrição	Valor	Item	Descrição	Valor
01	01	01	01
02	02	02	02
03	03	03	03
04	04	04	04
05	05	05	05
06	06	06	06
07	07	07	07
08	08	08	08
09	09	09	09
10	10	10	10
11	11	11	11
12	12	12	12
13	13	13	13
14	14	14	14
15	15	15	15
16	16	16	16
17	17	17	17
18	18	18	18
19	19	19	19
20	20	20	20
21	21	21	21
22	22	22	22
23	23	23	23
24	24	24	24
25	25	25	25
26	26	26	26
27	27	27	27
28	28	28	28
29	29	29	29
30	30	30	30
31	31	31	31
32	32	32	32
33	33	33	33
34	34	34	34
35	35	35	35
36	36	36	36
37	37	37	37
38	38	38	38
39	39	39	39
40	40	40	40
41	41	41	41
42	42	42	42
43	43	43	43
44	44	44	44
45	45	45	45
46	46	46	46
47	47	47	47
48	48	48	48
49	49	49	49
50	50	50	50
51	51	51	51
52	52	52	52
53	53	53	53
54	54	54	54
55	55	55	55
56	56	56	56
57	57	57	57
58	58	58	58
59	59	59	59
60	60	60	60
61	61	61	61
62	62	62	62
63	63	63	63
64	64	64	64
65	65	65	65
66	66	66	66
67	67	67	67
68	68	68	68
69	69	69	69
70	70	70	70
71	71	71	71
72	72	72	72
73	73	73	73
74	74	74	74
75	75	75	75
76	76	76	76
77	77	77	77
78	78	78	78
79	79	79	79
80	80	80	80
81	81	81	81
82	82	82	82
83	83	83	83
84	84	84	84
85	85	85	85
86	86	86	86
87	87	87	87
88	88	88	88
89	89	89	89
90	90	90	90
91	91	91	91
92	92	92	92
93	93	93	93
94	94	94	94
95	95	95	95
96	96	96	96
97	97	97	97
98	98	98	98
99	99	99	99
100	100	100	100



ECOMUNDA

A. ERROG

CORTE



MUNICÍPIO MUNICIPAL DE GUARANÁ DO NORTE
 RECLAMAÇÃO DE ESTRADAS VICIADAS NO MUNICÍPIO DE GUARANÁ DO NORTE - SE - PT 10667000
 SEÇÃO TRANVERSAL

5 / 73

ASC

Município		Município		Município		Município		Município		Município	
Item	Descrição	Item	Descrição	Item	Descrição	Item	Descrição	Item	Descrição	Item	Descrição
01	...	01	...	01	...	01	...	01	...	01	...
02	...	02	...	02	...	02	...	02	...	02	...
03	...	03	...	03	...	03	...	03	...	03	...
04	...	04	...	04	...	04	...	04	...	04	...
05	...	05	...	05	...	05	...	05	...	05	...
06	...	06	...	06	...	06	...	06	...	06	...
07	...	07	...	07	...	07	...	07	...	07	...
08	...	08	...	08	...	08	...	08	...	08	...
09	...	09	...	09	...	09	...	09	...	09	...
10	...	10	...	10	...	10	...	10	...	10	...
11	...	11	...	11	...	11	...	11	...	11	...
12	...	12	...	12	...	12	...	12	...	12	...
13	...	13	...	13	...	13	...	13	...	13	...
14	...	14	...	14	...	14	...	14	...	14	...
15	...	15	...	15	...	15	...	15	...	15	...
16	...	16	...	16	...	16	...	16	...	16	...
17	...	17	...	17	...	17	...	17	...	17	...
18	...	18	...	18	...	18	...	18	...	18	...
19	...	19	...	19	...	19	...	19	...	19	...
20	...	20	...	20	...	20	...	20	...	20	...
21	...	21	...	21	...	21	...	21	...	21	...
22	...	22	...	22	...	22	...	22	...	22	...
23	...	23	...	23	...	23	...	23	...	23	...
24	...	24	...	24	...	24	...	24	...	24	...
25	...	25	...	25	...	25	...	25	...	25	...
26	...	26	...	26	...	26	...	26	...	26	...
27	...	27	...	27	...	27	...	27	...	27	...
28	...	28	...	28	...	28	...	28	...	28	...
29	...	29	...	29	...	29	...	29	...	29	...
30	...	30	...	30	...	30	...	30	...	30	...
31	...	31	...	31	...	31	...	31	...	31	...
32	...	32	...	32	...	32	...	32	...	32	...
33	...	33	...	33	...	33	...	33	...	33	...
34	...	34	...	34	...	34	...	34	...	34	...
35	...	35	...	35	...	35	...	35	...	35	...
36	...	36	...	36	...	36	...	36	...	36	...
37	...	37	...	37	...	37	...	37	...	37	...
38	...	38	...	38	...	38	...	38	...	38	...
39	...	39	...	39	...	39	...	39	...	39	...
40	...	40	...	40	...	40	...	40	...	40	...
41	...	41	...	41	...	41	...	41	...	41	...
42	...	42	...	42	...	42	...	42	...	42	...
43	...	43	...	43	...	43	...	43	...	43	...
44	...	44	...	44	...	44	...	44	...	44	...
45	...	45	...	45	...	45	...	45	...	45	...
46	...	46	...	46	...	46	...	46	...	46	...
47	...	47	...	47	...	47	...	47	...	47	...
48	...	48	...	48	...	48	...	48	...	48	...
49	...	49	...	49	...	49	...	49	...	49	...
50	...	50	...	50	...	50	...	50	...	50	...
51	...	51	...	51	...	51	...	51	...	51	...
52	...	52	...	52	...	52	...	52	...	52	...
53	...	53	...	53	...	53	...	53	...	53	...
54	...	54	...	54	...	54	...	54	...	54	...
55	...	55	...	55	...	55	...	55	...	55	...
56	...	56	...	56	...	56	...	56	...	56	...
57	...	57	...	57	...	57	...	57	...	57	...
58	...	58	...	58	...	58	...	58	...	58	...
59	...	59	...	59	...	59	...	59	...	59	...
60	...	60	...	60	...	60	...	60	...	60	...
61	...	61	...	61	...	61	...	61	...	61	...
62	...	62	...	62	...	62	...	62	...	62	...
63	...	63	...	63	...	63	...	63	...	63	...
64	...	64	...	64	...	64	...	64	...	64	...
65	...	65	...	65	...	65	...	65	...	65	...
66	...	66	...	66	...	66	...	66	...	66	...
67	...	67	...	67	...	67	...	67	...	67	...
68	...	68	...	68	...	68	...	68	...	68	...
69	...	69	...	69	...	69	...	69	...	69	...
70	...	70	...	70	...	70	...	70	...	70	...
71	...	71	...	71	...	71	...	71	...	71	...
72	...	72	...	72	...	72	...	72	...	72	...
73	...	73	...	73	...	73	...	73	...	73	...
74	...	74	...	74	...	74	...	74	...	74	...
75	...	75	...	75	...	75	...	75	...	75	...
76	...	76	...	76	...	76	...	76	...	76	...
77	...	77	...	77	...	77	...	77	...	77	...
78	...	78	...	78	...	78	...	78	...	78	...
79	...	79	...	79	...	79	...	79	...	79	...
80	...	80	...	80	...	80	...	80	...	80	...
81	...	81	...	81	...	81	...	81	...	81	...
82	...	82	...	82	...	82	...	82	...	82	...
83	...	83	...	83	...	83	...	83	...	83	...
84	...	84	...	84	...	84	...	84	...	84	...
85	...	85	...	85	...	85	...	85	...	85	...
86	...	86	...	86	...	86	...	86	...	86	...
87	...	87	...	87	...	87	...	87	...	87	...
88	...	88	...	88	...	88	...	88	...	88	...
89	...	89	...	89	...	89	...	89	...	89	...
90	...	90	...	90	...	90	...	90	...	90	...
91	...	91	...	91	...	91	...	91	...	91	...
92	...	92	...	92	...	92	...	92	...	92	...
93	...	93	...	93	...	93	...	93	...	93	...
94	...	94	...	94	...	94	...	94	...	94	...
95	...	95	...	95	...	95	...	95	...	95	...
96	...	96	...	96	...	96	...	96	...	96	...
97	...	97	...	97	...	97	...	97	...	97	...
98	...	98	...	98	...	98	...	98	...	98	...
99	...	99	...	99	...	99	...	99	...	99	...
100	...	100	...	100	...	100	...	100	...	100	...



SECRETARIA MUNICIPAL DE ADMINISTRAÇÃO

PREFEITURA MUNICIPAL DE GUARANÁ DO NORTE

RECURSOS DE ESTRAÇAS VICINAIS NO MUNICÍPIO DE GUARANÁ DO NORTE - PI 10827-03

SEÇÃO DE TRANSPORTES

ALUGUELO DE VEÍCULO

ATA Nº 13

6 / 13

2008

ATA Nº 13

6 / 13

2008

ALTERADO

CORTE

LEGENDA

MUNICÍPIO		MUNICÍPIO		MUNICÍPIO		MUNICÍPIO		MUNICÍPIO		MUNICÍPIO		MUNICÍPIO		MUNICÍPIO	
ANO	VALOR	ANO	VALOR	ANO	VALOR	ANO	VALOR	ANO	VALOR	ANO	VALOR	ANO	VALOR	ANO	VALOR
2000	1000000000	2000	1000000000	2000	1000000000	2000	1000000000	2000	1000000000	2000	1000000000	2000	1000000000	2000	1000000000
2001	1000000000	2001	1000000000	2001	1000000000	2001	1000000000	2001	1000000000	2001	1000000000	2001	1000000000	2001	1000000000
2002	1000000000	2002	1000000000	2002	1000000000	2002	1000000000	2002	1000000000	2002	1000000000	2002	1000000000	2002	1000000000
2003	1000000000	2003	1000000000	2003	1000000000	2003	1000000000	2003	1000000000	2003	1000000000	2003	1000000000	2003	1000000000
2004	1000000000	2004	1000000000	2004	1000000000	2004	1000000000	2004	1000000000	2004	1000000000	2004	1000000000	2004	1000000000
2005	1000000000	2005	1000000000	2005	1000000000	2005	1000000000	2005	1000000000	2005	1000000000	2005	1000000000	2005	1000000000
2006	1000000000	2006	1000000000	2006	1000000000	2006	1000000000	2006	1000000000	2006	1000000000	2006	1000000000	2006	1000000000
2007	1000000000	2007	1000000000	2007	1000000000	2007	1000000000	2007	1000000000	2007	1000000000	2007	1000000000	2007	1000000000
2008	1000000000	2008	1000000000	2008	1000000000	2008	1000000000	2008	1000000000	2008	1000000000	2008	1000000000	2008	1000000000
2009	1000000000	2009	1000000000	2009	1000000000	2009	1000000000	2009	1000000000	2009	1000000000	2009	1000000000	2009	1000000000
2010	1000000000	2010	1000000000	2010	1000000000	2010	1000000000	2010	1000000000	2010	1000000000	2010	1000000000	2010	1000000000
2011	1000000000	2011	1000000000	2011	1000000000	2011	1000000000	2011	1000000000	2011	1000000000	2011	1000000000	2011	1000000000
2012	1000000000	2012	1000000000	2012	1000000000	2012	1000000000	2012	1000000000	2012	1000000000	2012	1000000000	2012	1000000000
2013	1000000000	2013	1000000000	2013	1000000000	2013	1000000000	2013	1000000000	2013	1000000000	2013	1000000000	2013	1000000000
2014	1000000000	2014	1000000000	2014	1000000000	2014	1000000000	2014	1000000000	2014	1000000000	2014	1000000000	2014	1000000000
2015	1000000000	2015	1000000000	2015	1000000000	2015	1000000000	2015	1000000000	2015	1000000000	2015	1000000000	2015	1000000000
2016	1000000000	2016	1000000000	2016	1000000000	2016	1000000000	2016	1000000000	2016	1000000000	2016	1000000000	2016	1000000000
2017	1000000000	2017	1000000000	2017	1000000000	2017	1000000000	2017	1000000000	2017	1000000000	2017	1000000000	2017	1000000000
2018	1000000000	2018	1000000000	2018	1000000000	2018	1000000000	2018	1000000000	2018	1000000000	2018	1000000000	2018	1000000000
2019	1000000000	2019	1000000000	2019	1000000000	2019	1000000000	2019	1000000000	2019	1000000000	2019	1000000000	2019	1000000000
2020	1000000000	2020	1000000000	2020	1000000000	2020	1000000000	2020	1000000000	2020	1000000000	2020	1000000000	2020	1000000000



PREFEITURA MUNICIPAL DE GUARACIABA DO NORTE
SECRETARIA DE ESTADOS VICINA E DO MUNICÍPIO DE GUARACIABA
SECRETARIA DE FINANÇAS

ATA Nº 003
DE 17/07/2020

RELAÇÃO DE PREÇOS DE SERVIÇOS DE MANUTENÇÃO DE VEÍCULOS

DATA: 17/07/2020

LEI Nº 000
ATRASO
CORRE

LEGENÇA

ALCERRO

CORTE





PREFEITURA MUNICIPAL DE GIARACABA DO NORTE
 RECUPERAÇÃO DE ESTRADAS VICINAIS NO MUNICÍPIO DE GIARACABA DO NORTE - CE - PT 108620003
 SEÇÕES TRANSVERSAIS

PROJETO DE ARQUITETURA, ENGENHARIA E GEOMETRIA
 PROJETO DE ARQUITETURA, ENGENHARIA E GEOMETRIA

9 / 73



LEGENDA

-  ATERRO
-  COARTE

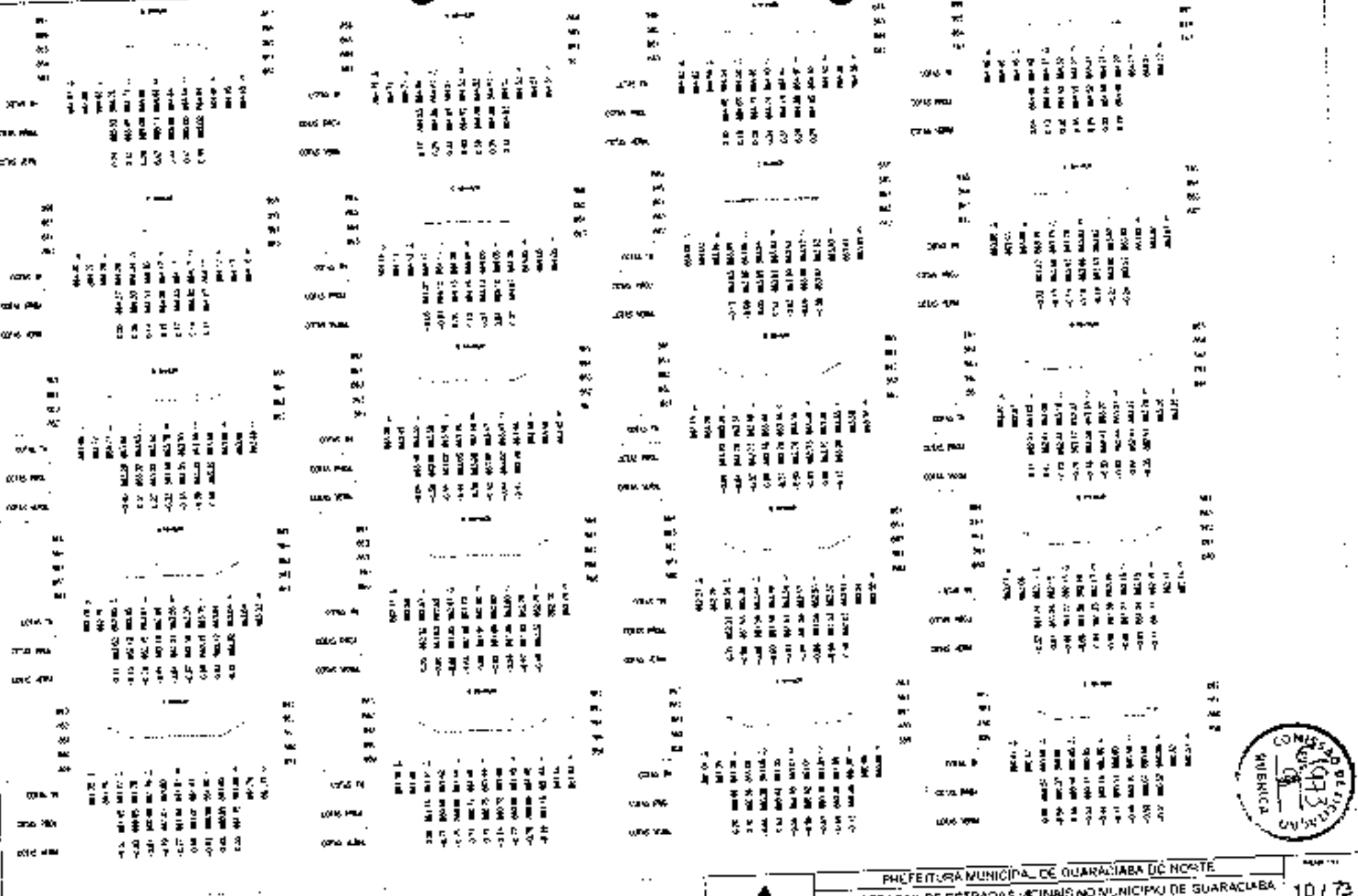



PREFEITURA MUNICIPAL DE GUARACABA DO NORTE
 RECUPERAÇÃO DE ESTRADAS VICINAIS NO MUNICÍPIO DE GUARACABA DO NORTE-CE - ET 1086270-03
 SEÇÕES TRANSVERSAIS



10173
 1056

LEGENDA

-  ATERRÇO
-  CORTC



PREFEITURA MUNICIPAL DE GUARACIASA DO NORTE
 RECUPERAÇÃO DE ESTRADAS VICINAIS NO MUNICÍPIO DE GUARACIASA
 DO NORTE - CE - PT 1306270-DJ
 SEÇÕES TRANSVERSAIS



PROJETO DE ARQUITETURA E ENGENHARIA
 ARQUITETO: [Illegible]
 ENGENHEIRO: [Illegible]

11 / 72

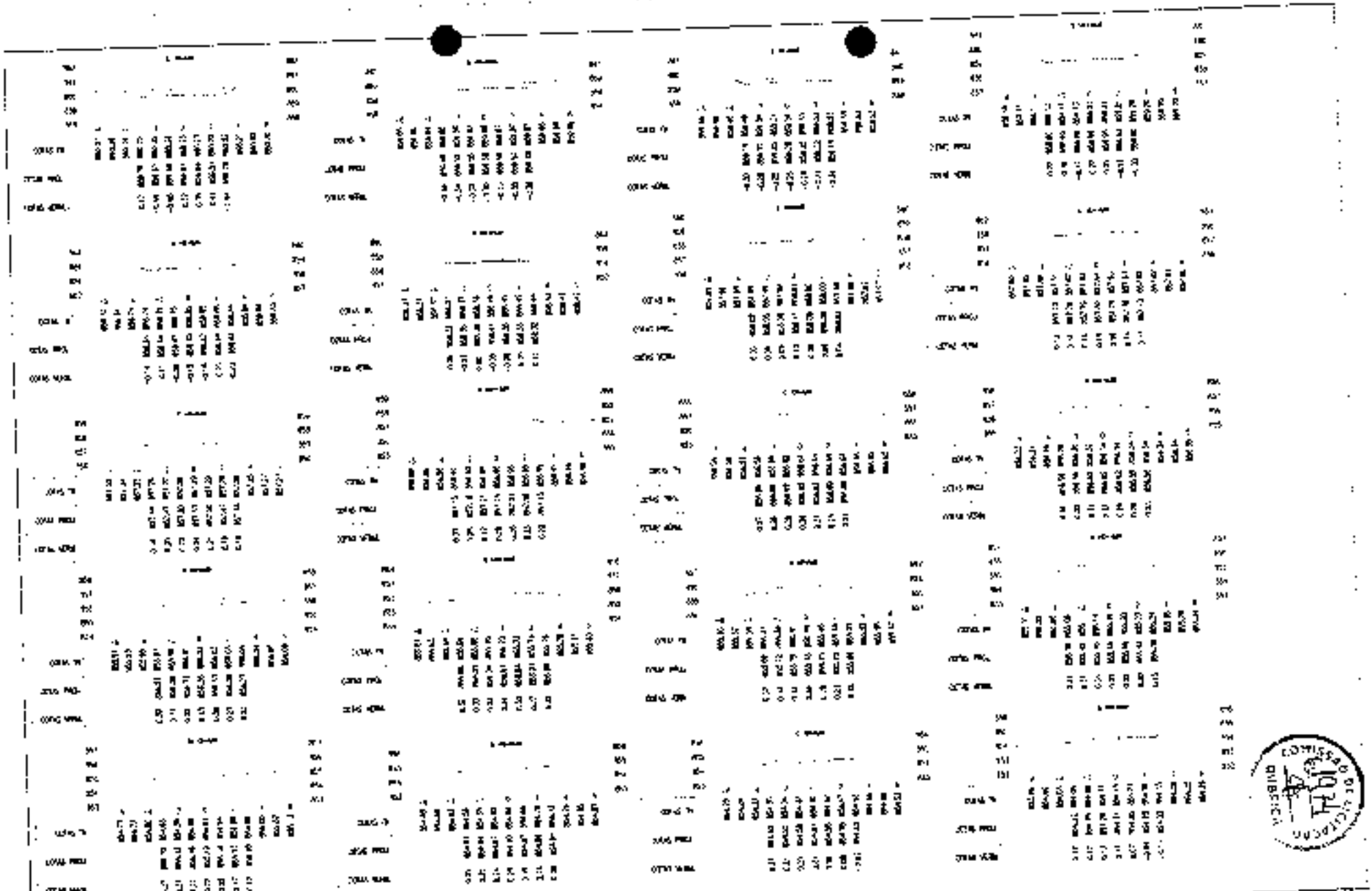
1050



LEGENDA

-  ATENÇÃO
-  CURTE

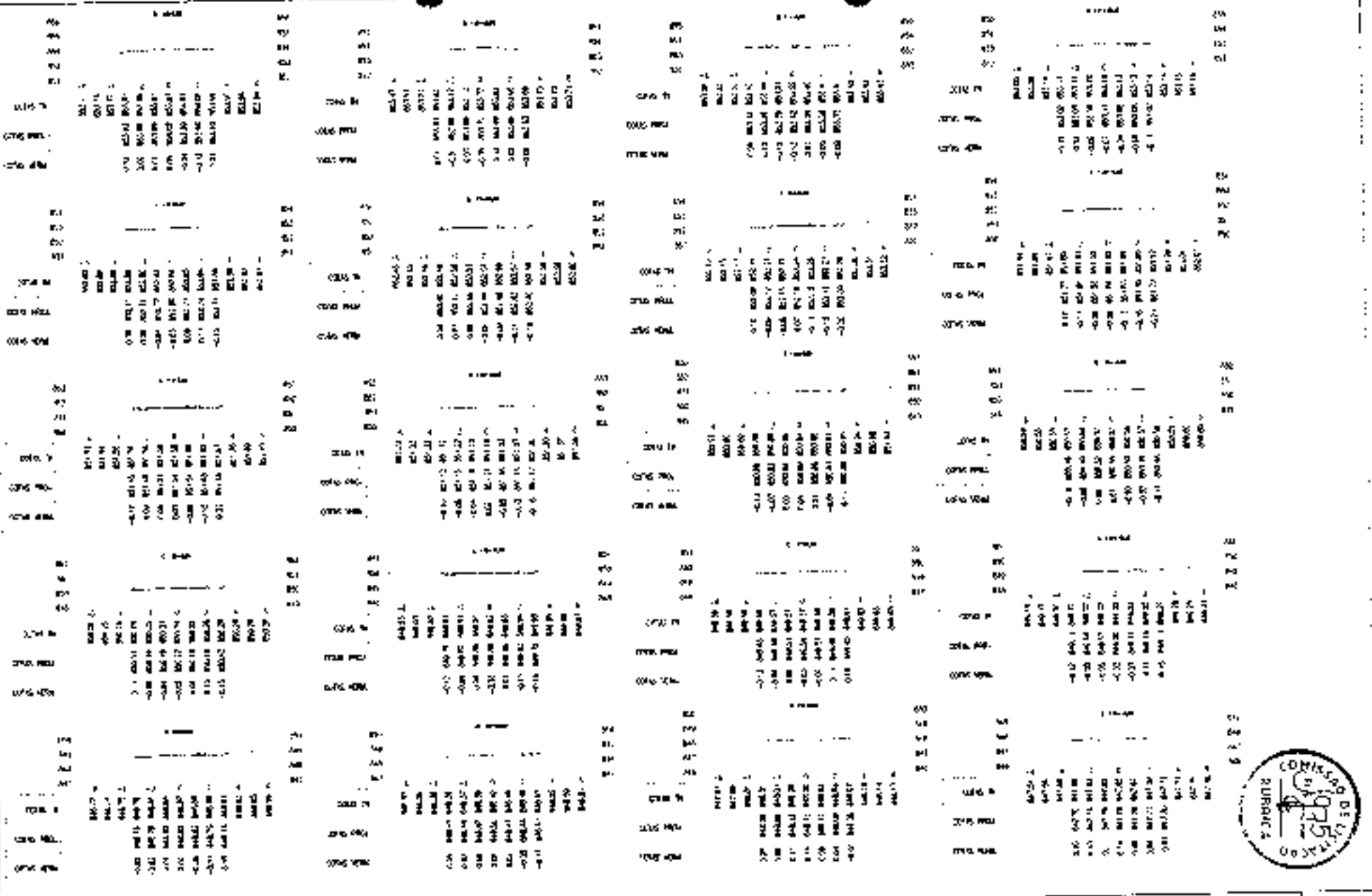

PREFEITURA MUNICIPAL DE GUARACIABA DO NORTE
 RECUPERAÇÃO DE ESTRADAS VICINAIS NO MUNICÍPIO DE GUARACIABA DO NORTE - CE - PT 10882/2014
 SEÇÃO TRANSVERSAIS

PROPOSTA: ...
 VALOR: ...



12/73
 1280

LEGENDA

ATERRO

CORTE



JOTA BRANCO S.A.



PREFEITURA MUNICIPAL DE GUARACIABA DO NORTE
RECUPERAÇÃO DE ESTRADAS VICINAIS NO MUNICÍPIO DE GUARACIABA DO NORTE - CE - PT 10827000
SEÇÕES TRANSVERSAIS

13172

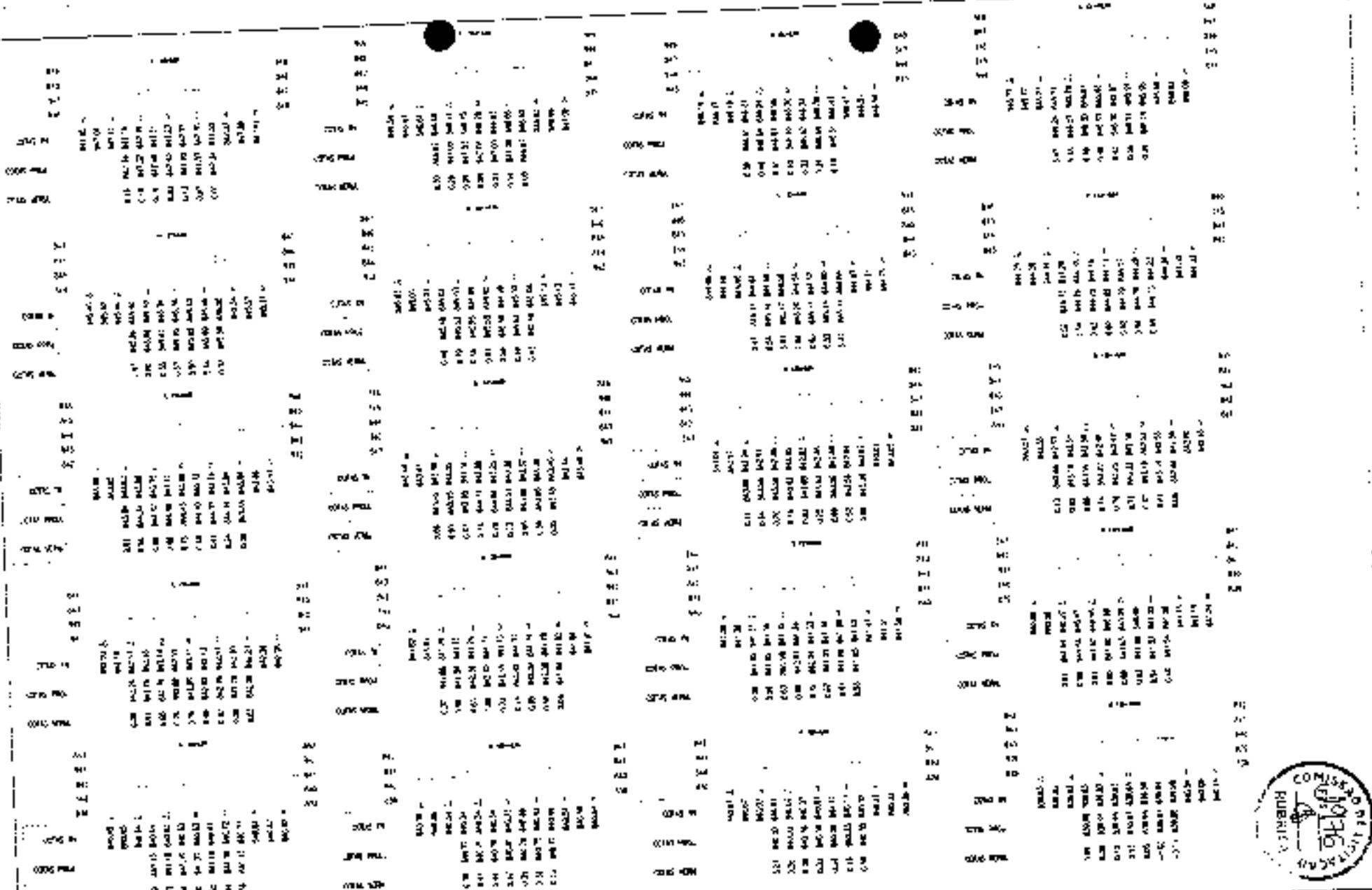
1052



LEGENDA

-  ATERRO
-  CORTA

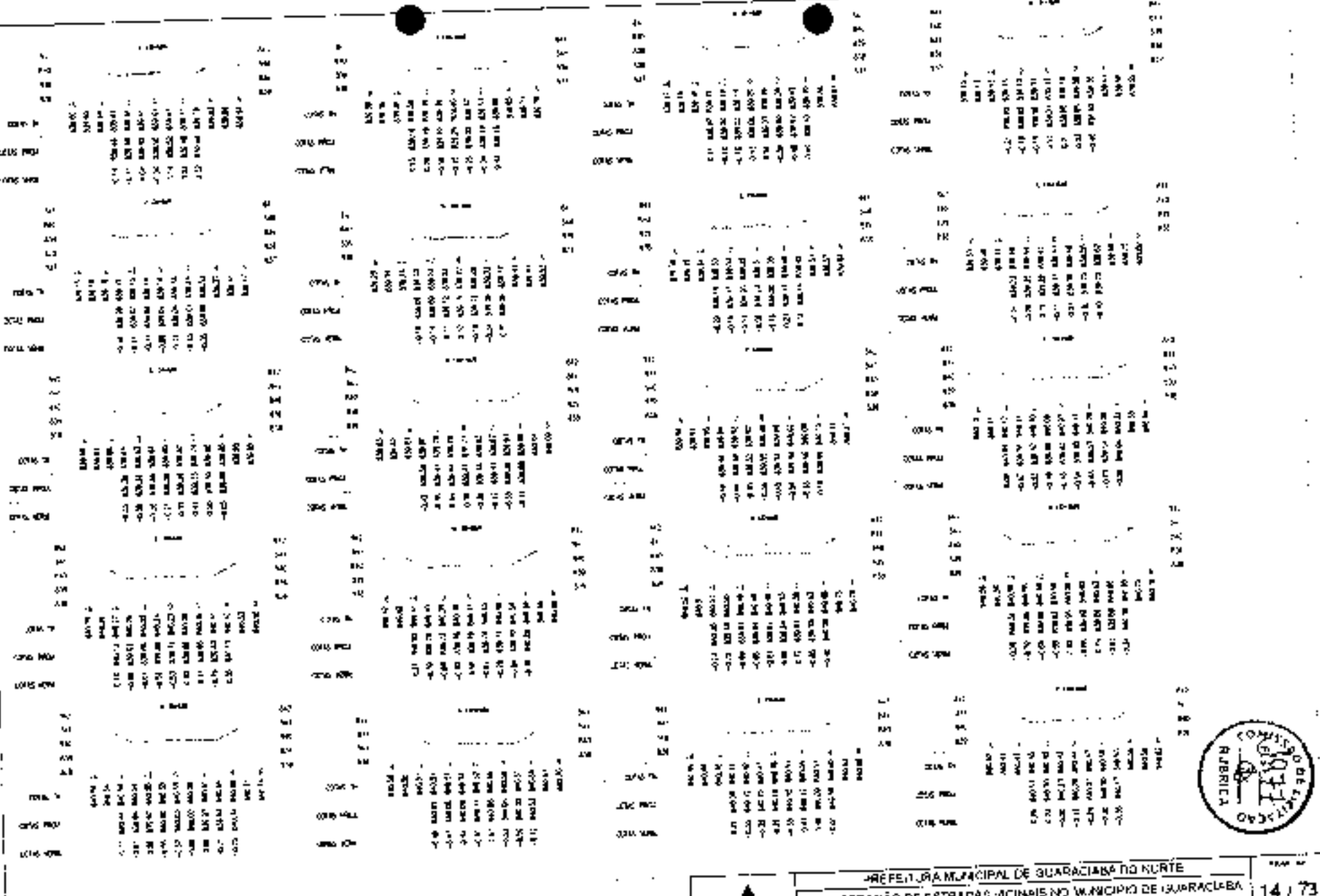

PREFEITURA MUNICIPAL DE GUARACIABA DO NORTE
 RECUPERAÇÃO DE ESTRADAS VICINAIS NO MUNICÍPIO DE GUARACIABA DO NORTE - CE - IPT 1085270-03
 SEÇÕES TRANSVERSAIS

14 / 73



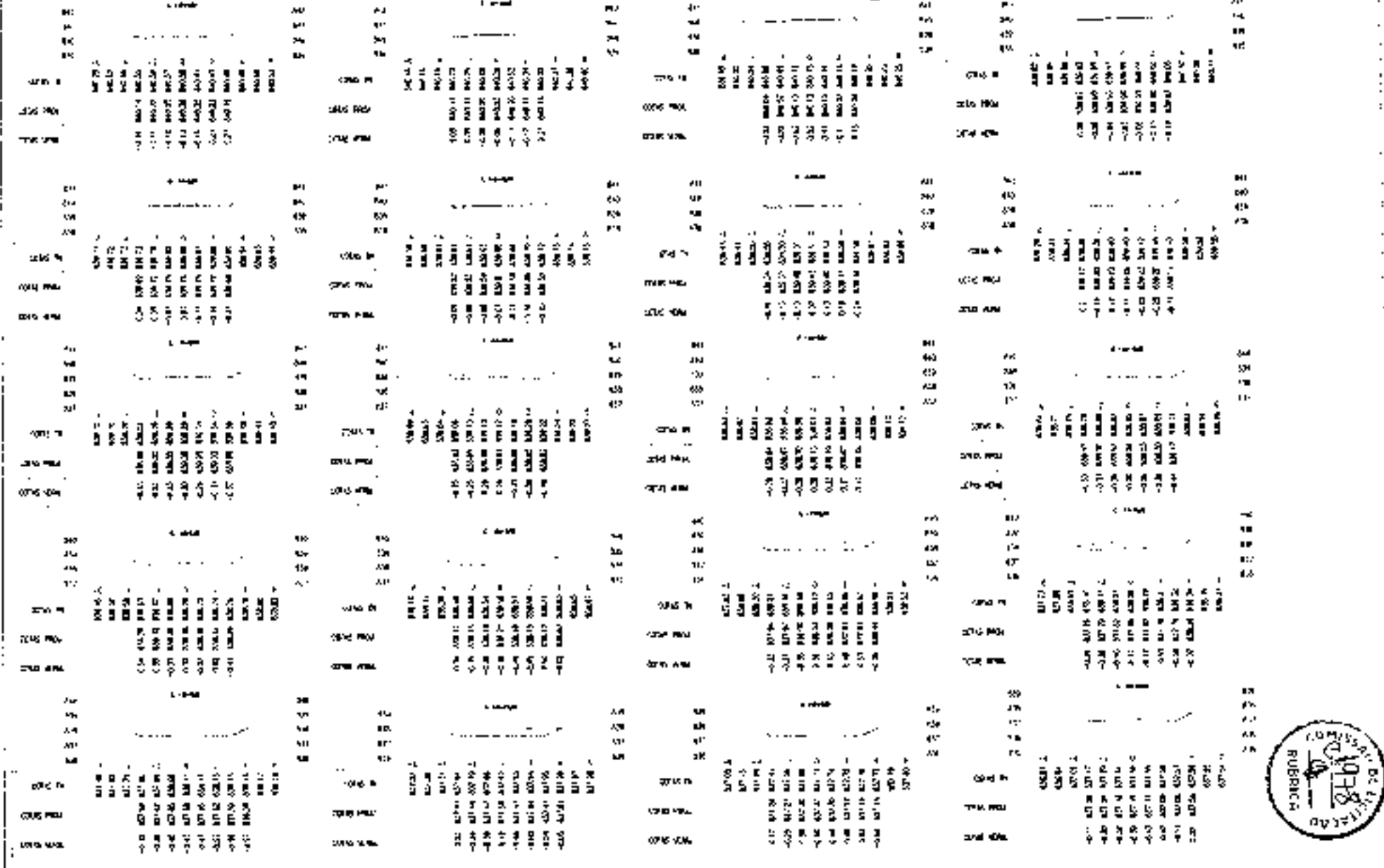

LEGENDA

 ATERRO
 CORTE



PREFEITURA MUNICIPAL DE GUARACIABA DO NORTE RECUPERAÇÃO DE ESTRADAS VICINAIS NO MUNICÍPIO DE GUARACIABA DO NORTE-CE - P1 008270-03 SEÇÕES TRANSVERSAIS		15 / 73 1/250
PROJETO	RECUPERAÇÃO DE ESTRADAS VICINAIS	
LABOR	PROJETO DE RECONSTRUÇÃO DE ESTRADAS VICINAIS	



LEGENDA

ATERRO
CORRE

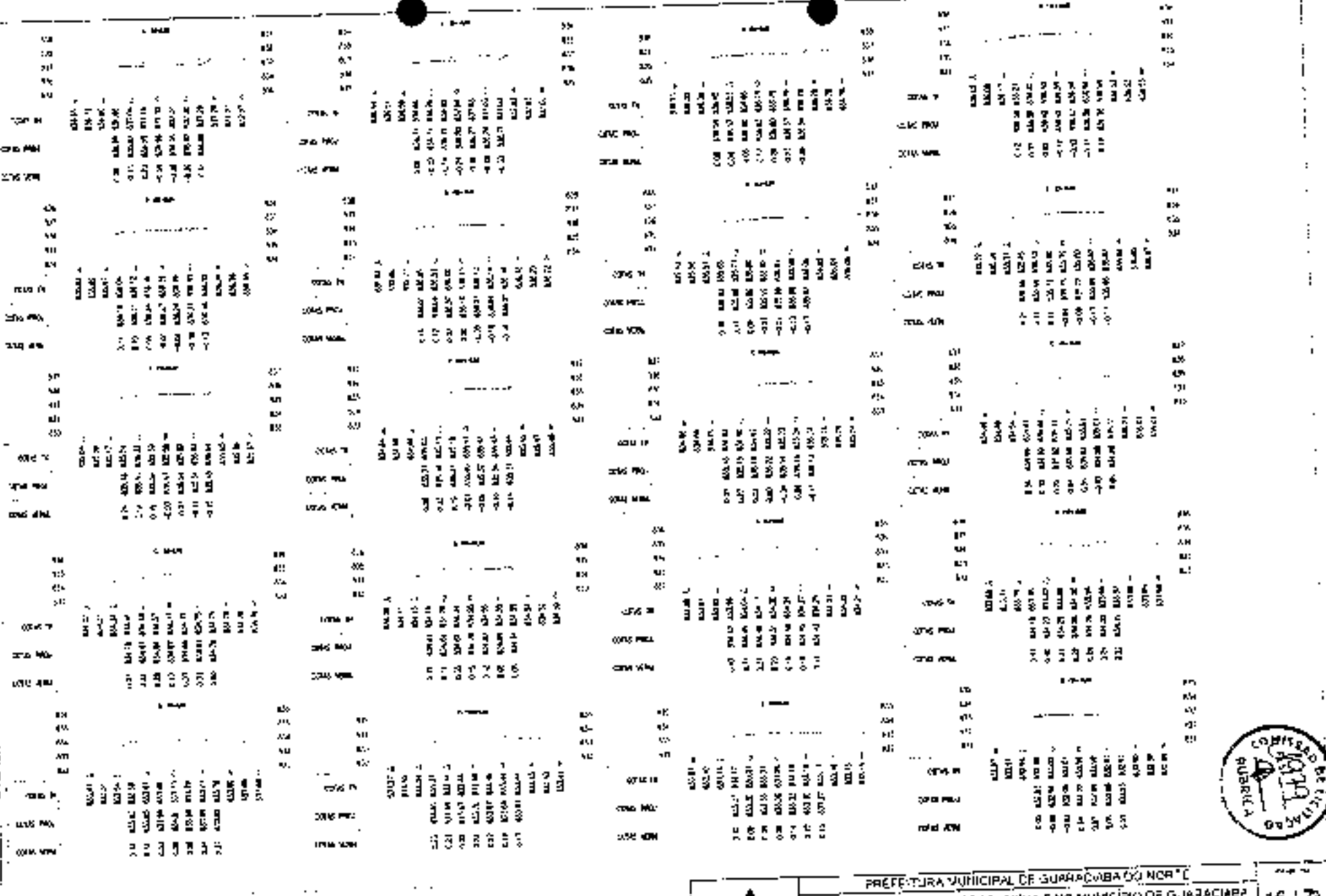

PREFEITURA MUNICIPAL DE GUARACIABA DO NORTE
 RECAPTAÇÃO DE FORTAÇAS VICINAIS NO MUNICÍPIO DE GUARACIABA
 DO NORTE-CE - PT 1082/0-03
 SEÇÕES TRANSVERSAIS

PROPOSTA Nº 001/2003
 VALOR R\$ 1.000,00

16 / 72
 1082



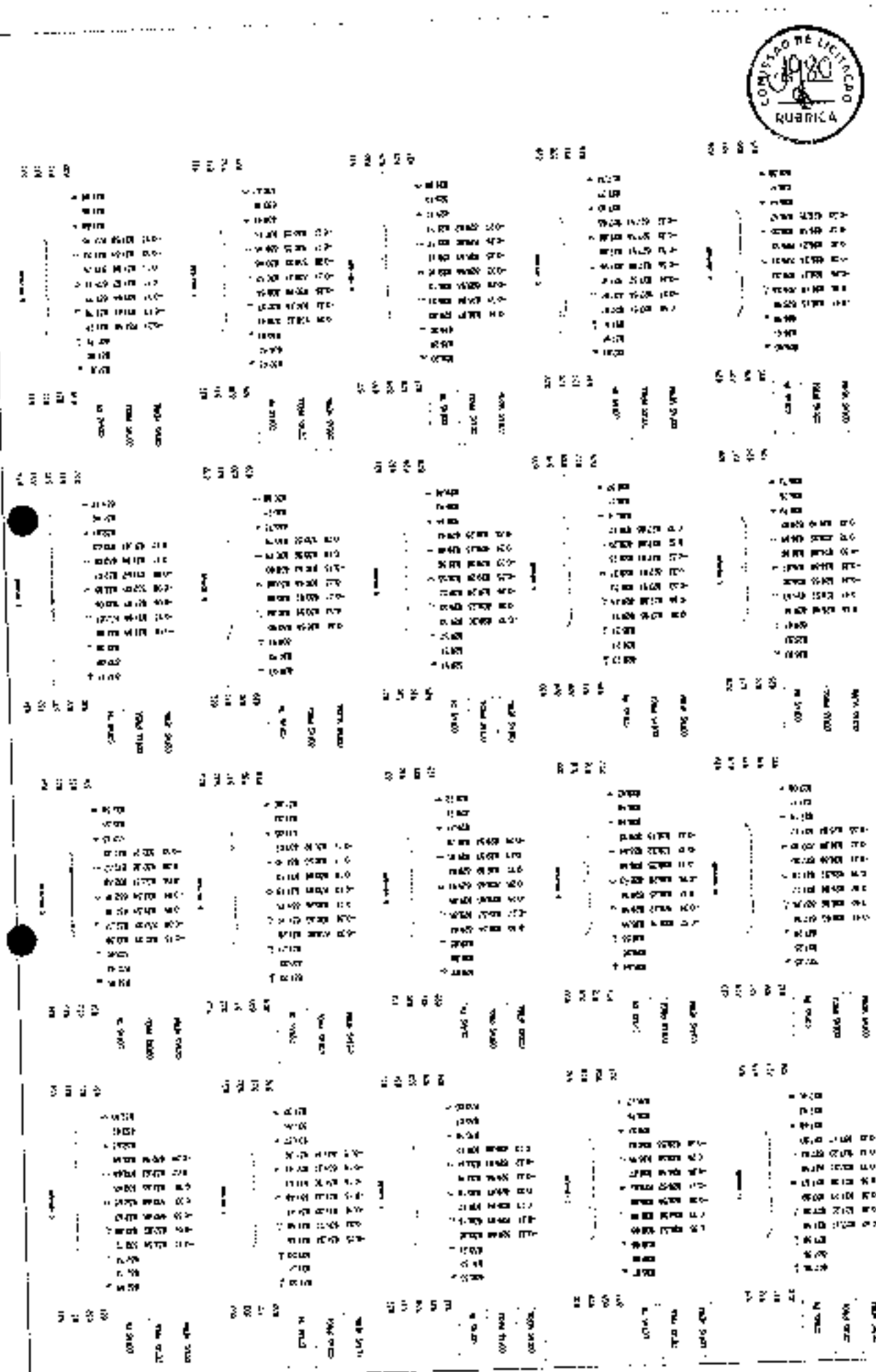

PREFEITURA MUNICIPAL DE GUARUJÁ DO NORTE
 RECUPERAÇÃO DE ESTRADAS VICINAS AO MUNICÍPIO DE GUARUJÁ DO N
 CO-MORTE-CE-PT-12687200
 BECÕES TRANSVERSAIS



LEGENDA
 [] ATERRO
 [] CORTE



Item	Descrição	Quantidade	Valor Unitário	Valor Total
001
002
003
004
005
006
007
008
009
010
011
012
013
014
015
016
017
018
019
020
021
022
023
024
025
026
027
028
029
030
031
032
033
034
035
036
037
038
039
040
041
042
043
044
045
046
047
048
049
050
051
052
053
054
055
056
057
058
059
060
061
062
063
064
065
066
067
068
069
070
071
072
073
074
075
076
077
078
079
080
081
082
083
084
085
086
087
088
089
090
091
092
093
094
095
096
097
098
099
100

LEILÃO Nº 18/73
RECUPERAÇÃO DE ESTRADAS VICINAS AO MUNICÍPIO DE QUARUCEMA DO NORTE - PE - PT 10827003
REGIÃO TRANSMONTANA
COMISSÃO DE LICITAÇÃO PÚBLICA
MUNICÍPIO DE QUARUCEMA
18/73
LEILÃO Nº 18/73
RECUPERAÇÃO DE ESTRADAS VICINAS AO MUNICÍPIO DE QUARUCEMA DO NORTE - PE - PT 10827003
REGIÃO TRANSMONTANA
COMISSÃO DE LICITAÇÃO PÚBLICA
MUNICÍPIO DE QUARUCEMA
18/73

Item	Descrição	Valor	Item	Descrição	Valor	Item	Descrição	Valor	Item	Descrição	Valor	Item	Descrição	Valor
001	002	003	004	005



PREFEITURA MUNICIPAL DE GUARUJUBA DO NORTE
RECUPERAÇÃO DE ESTRADAS VICINAIS NO MUNICÍPIO DE GUARUJUBA DO NORTE - CE - PT 1086270-05
SEÇÕES TRANSVERSAIS

19/73

LEONARDO

ATERRE

FORTE

Lote nº		Área (m²)		Valor (R\$)		Observações	
Ant.	Post.	Ant.	Post.	Ant.	Post.	Ant.	Post.
01	01	100	100	10000	10000		
02	02	100	100	10000	10000		
03	03	100	100	10000	10000		
04	04	100	100	10000	10000		
05	05	100	100	10000	10000		
06	06	100	100	10000	10000		
07	07	100	100	10000	10000		
08	08	100	100	10000	10000		
09	09	100	100	10000	10000		
10	10	100	100	10000	10000		
11	11	100	100	10000	10000		
12	12	100	100	10000	10000		
13	13	100	100	10000	10000		
14	14	100	100	10000	10000		
15	15	100	100	10000	10000		
16	16	100	100	10000	10000		
17	17	100	100	10000	10000		
18	18	100	100	10000	10000		
19	19	100	100	10000	10000		
20	20	100	100	10000	10000		
21	21	100	100	10000	10000		
22	22	100	100	10000	10000		
23	23	100	100	10000	10000		
24	24	100	100	10000	10000		
25	25	100	100	10000	10000		
26	26	100	100	10000	10000		
27	27	100	100	10000	10000		
28	28	100	100	10000	10000		
29	29	100	100	10000	10000		
30	30	100	100	10000	10000		
31	31	100	100	10000	10000		
32	32	100	100	10000	10000		
33	33	100	100	10000	10000		
34	34	100	100	10000	10000		
35	35	100	100	10000	10000		
36	36	100	100	10000	10000		
37	37	100	100	10000	10000		
38	38	100	100	10000	10000		
39	39	100	100	10000	10000		
40	40	100	100	10000	10000		
41	41	100	100	10000	10000		
42	42	100	100	10000	10000		
43	43	100	100	10000	10000		
44	44	100	100	10000	10000		
45	45	100	100	10000	10000		
46	46	100	100	10000	10000		
47	47	100	100	10000	10000		
48	48	100	100	10000	10000		
49	49	100	100	10000	10000		
50	50	100	100	10000	10000		
51	51	100	100	10000	10000		
52	52	100	100	10000	10000		
53	53	100	100	10000	10000		
54	54	100	100	10000	10000		
55	55	100	100	10000	10000		
56	56	100	100	10000	10000		
57	57	100	100	10000	10000		
58	58	100	100	10000	10000		
59	59	100	100	10000	10000		
60	60	100	100	10000	10000		
61	61	100	100	10000	10000		
62	62	100	100	10000	10000		
63	63	100	100	10000	10000		
64	64	100	100	10000	10000		
65	65	100	100	10000	10000		
66	66	100	100	10000	10000		
67	67	100	100	10000	10000		
68	68	100	100	10000	10000		
69	69	100	100	10000	10000		
70	70	100	100	10000	10000		
71	71	100	100	10000	10000		
72	72	100	100	10000	10000		
73	73	100	100	10000	10000		
74	74	100	100	10000	10000		
75	75	100	100	10000	10000		
76	76	100	100	10000	10000		
77	77	100	100	10000	10000		
78	78	100	100	10000	10000		
79	79	100	100	10000	10000		
80	80	100	100	10000	10000		
81	81	100	100	10000	10000		
82	82	100	100	10000	10000		
83	83	100	100	10000	10000		
84	84	100	100	10000	10000		
85	85	100	100	10000	10000		
86	86	100	100	10000	10000		
87	87	100	100	10000	10000		
88	88	100	100	10000	10000		
89	89	100	100	10000	10000		
90	90	100	100	10000	10000		
91	91	100	100	10000	10000		
92	92	100	100	10000	10000		
93	93	100	100	10000	10000		
94	94	100	100	10000	10000		
95	95	100	100	10000	10000		
96	96	100	100	10000	10000		
97	97	100	100	10000	10000		
98	98	100	100	10000	10000		
99	99	100	100	10000	10000		
100	100	100	100	10000	10000		



COMISSÃO DE INVENTÁRIO PÚBLICO
2013
RUBRICA

PREFETURA MUNICIPAL DE QUARACIABA DO NORTE
RECUPIRAÇÃO DE ESTRADAS VICIAIS DO MUNICÍPIO DE QUARACIABA DO NORTE - CE - PI 100477003
SEÇÕES TERREIRAIS

LEGENDA
 [] ATERRIO
 [] CORTA

ATA
 Nº 001/2013
 Data: 20/07/2013

Parcela	Área (m²)	Valor	Parcela	Área (m²)	Valor	Parcela	Área (m²)	Valor	Parcela	Área (m²)	Valor	Parcela	Área (m²)	Valor
1	1000	10000	11	1000	10000	21	1000	10000	31	1000	10000	41	1000	10000
2	1000	10000	12	1000	10000	22	1000	10000	32	1000	10000	42	1000	10000
3	1000	10000	13	1000	10000	23	1000	10000	33	1000	10000	43	1000	10000
4	1000	10000	14	1000	10000	24	1000	10000	34	1000	10000	44	1000	10000
5	1000	10000	15	1000	10000	25	1000	10000	35	1000	10000	45	1000	10000
6	1000	10000	16	1000	10000	26	1000	10000	36	1000	10000	46	1000	10000
7	1000	10000	17	1000	10000	27	1000	10000	37	1000	10000	47	1000	10000
8	1000	10000	18	1000	10000	28	1000	10000	38	1000	10000	48	1000	10000
9	1000	10000	19	1000	10000	29	1000	10000	39	1000	10000	49	1000	10000
10	1000	10000	20	1000	10000	30	1000	10000	40	1000	10000	50	1000	10000





PREFEITURA MUNICIPAL DE GUARACIARA DO NORTE
 REGISTRAÇÃO DE ESCRITURAS VICINAIS NO MUNICÍPIO DE GUARACIARA DO NORTE - GE 1.011.08570-00
 BLOCOS TRANSERVAIS



21 / 73

LEGENDA
 ATERRO
 CORTE

LEGENDA

-  ATERRO
-  CORTE

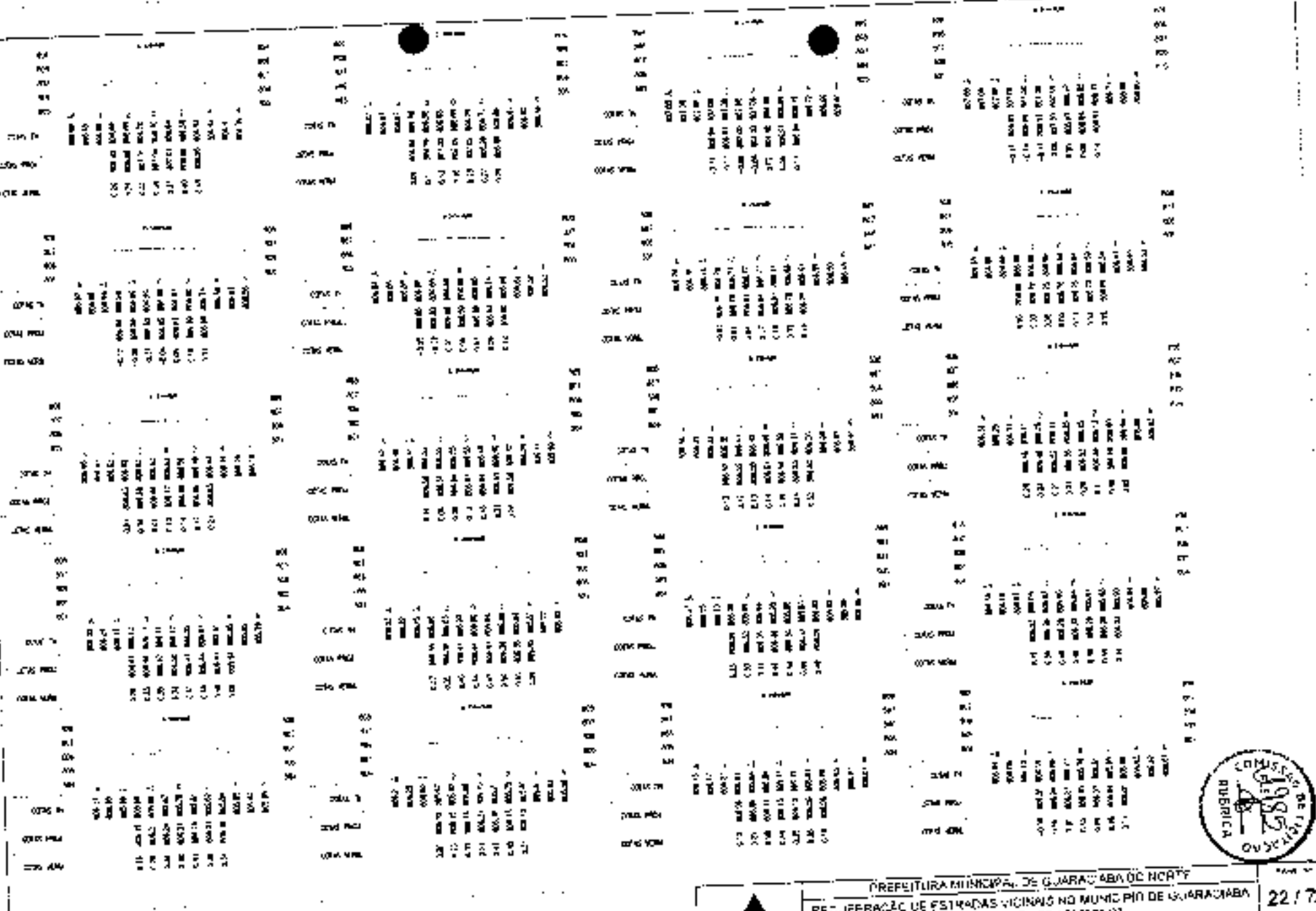

PREFEITURA MUNICIPAL DE GUARACIABA DO NORTE
 RECUPERAÇÃO DE ESTRADAS VICINAIS NO MUNICÍPIO DE GUARACIABA
 GO NORTE-DE - Fº 108627042
 SEÇÕES TRANSVERSAIS



22173

1756

LEGENDA

- ATERRO
- CORTIÇ

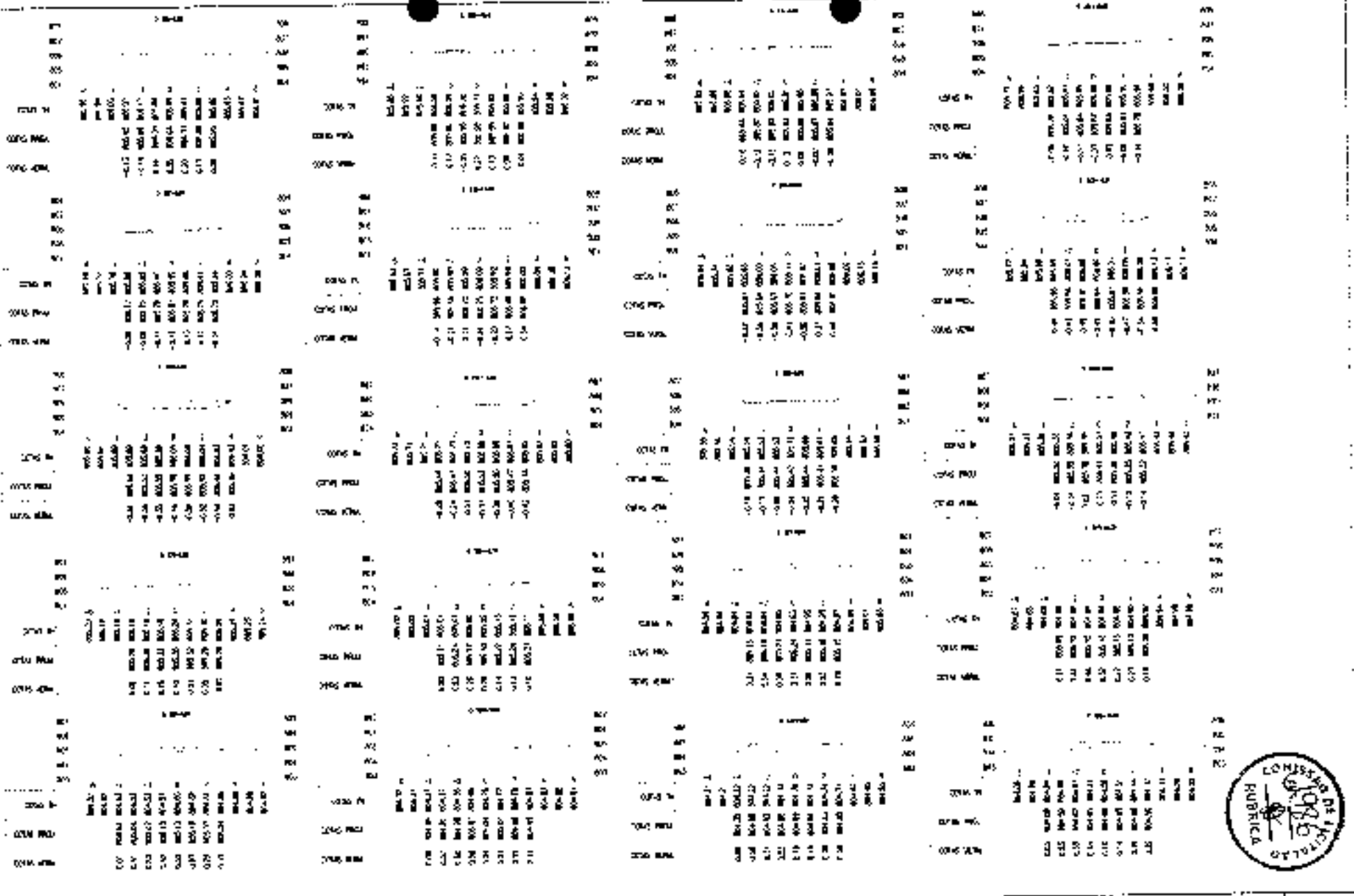

PREFEITURA MUNICIPAL DE GUARACIABA DO NORTE RECUPERAÇÃO DE ESTRADAS VICINAIS NO MUNICÍPIO DE GUARACIABA DO NORTE - CE - P.M. 85276-00 BÊCOES TRANSVERSAIS		Nº 23 / 73 U.S.C.
OBJETIVO	RECONSTRUIR E REPARAR O BÊCO TRANSVERSAIS Nº 11, 12, 13, 14, 15, 16, 17, 18, 19, 20, 21, 22, 23, 24, 25, 26, 27, 28, 29, 30, 31, 32, 33, 34, 35, 36, 37, 38, 39, 40, 41, 42, 43, 44, 45, 46, 47, 48, 49, 50, 51, 52, 53, 54, 55, 56, 57, 58, 59, 60, 61, 62, 63, 64, 65, 66, 67, 68, 69, 70, 71, 72, 73, 74, 75, 76, 77, 78, 79, 80, 81, 82, 83, 84, 85, 86, 87, 88, 89, 90, 91, 92, 93, 94, 95, 96, 97, 98, 99, 100.	
LUGAR	TR. 11, 12, 13, 14, 15, 16, 17, 18, 19, 20, 21, 22, 23, 24, 25, 26, 27, 28, 29, 30, 31, 32, 33, 34, 35, 36, 37, 38, 39, 40, 41, 42, 43, 44, 45, 46, 47, 48, 49, 50, 51, 52, 53, 54, 55, 56, 57, 58, 59, 60, 61, 62, 63, 64, 65, 66, 67, 68, 69, 70, 71, 72, 73, 74, 75, 76, 77, 78, 79, 80, 81, 82, 83, 84, 85, 86, 87, 88, 89, 90, 91, 92, 93, 94, 95, 96, 97, 98, 99, 100.	





PREFEITURA MUNICIPAL DE GUARACIABA DO NORTE	
RECUPERAÇÃO DE ESTRADAS MUNICIPAIS NO MUNICÍPIO DE GUARACIABA DO NORTE - PI 1086273-03	
SEÇÕES TRANSVERSAIS	
PROJETA	DR. CARLOS AUGUSTO MOURA DE MENEZES, ENGENHEIRO CIVIL
APROVA	DR. CARLOS AUGUSTO MOURA DE MENEZES, ENGENHEIRO CIVIL

DATA	24 / 73
ESCALA	1:500

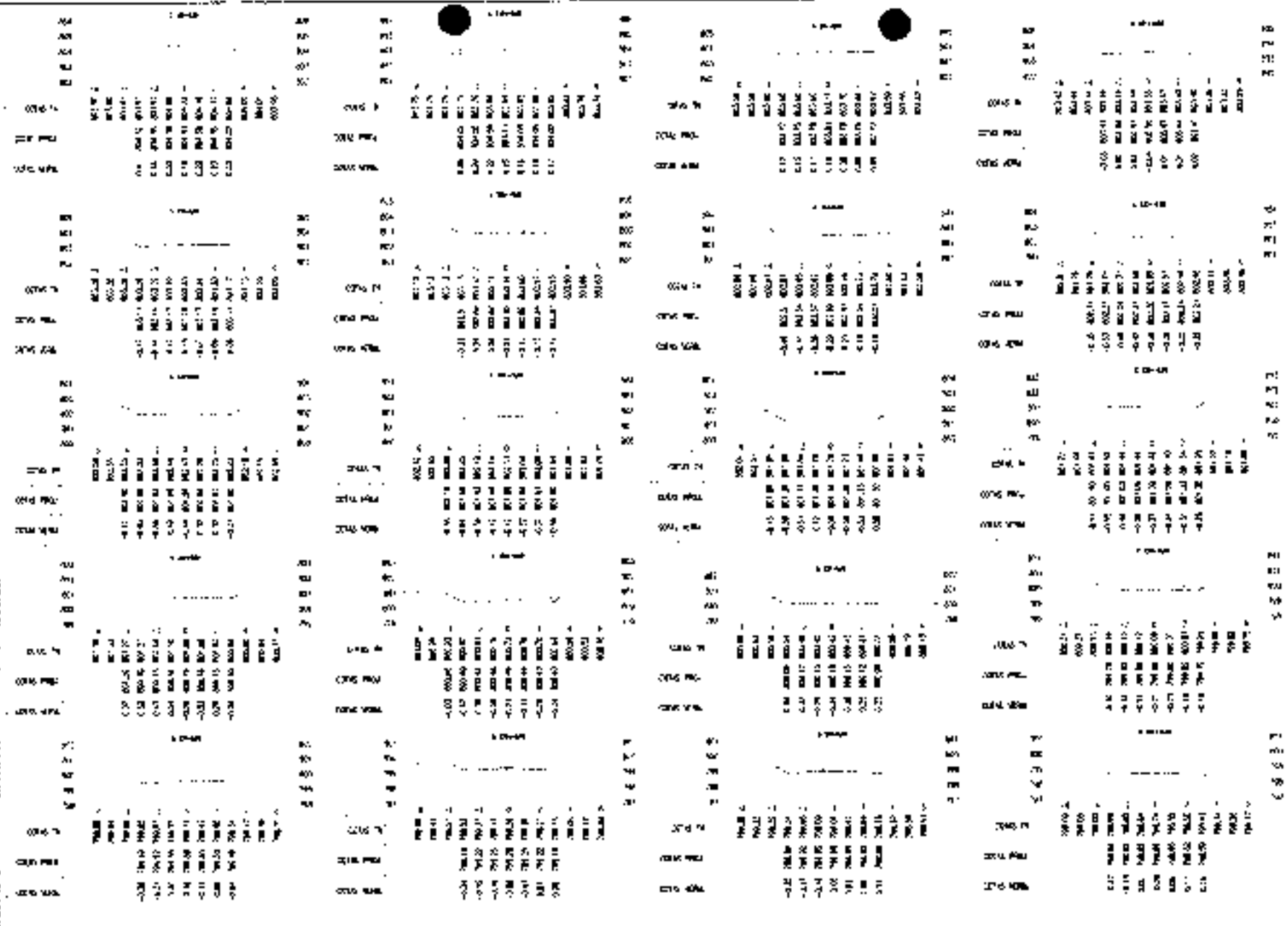

LEGENDA

	ATERRO
	CORTE

LEGENDA

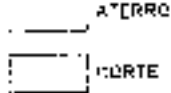

PROFILTRA MUNICIPAL DE GUARACIAS DO NORTE
 RECUPERAÇÃO DE ESTRADAS VICINAS NO MUNICIPIO DE GUARACIAS DO NORTE-CE - PT 085270-05
 SEÇÃO TRANSVERSAIS

PROJETO: []
 LOCAL: []

25 / 73

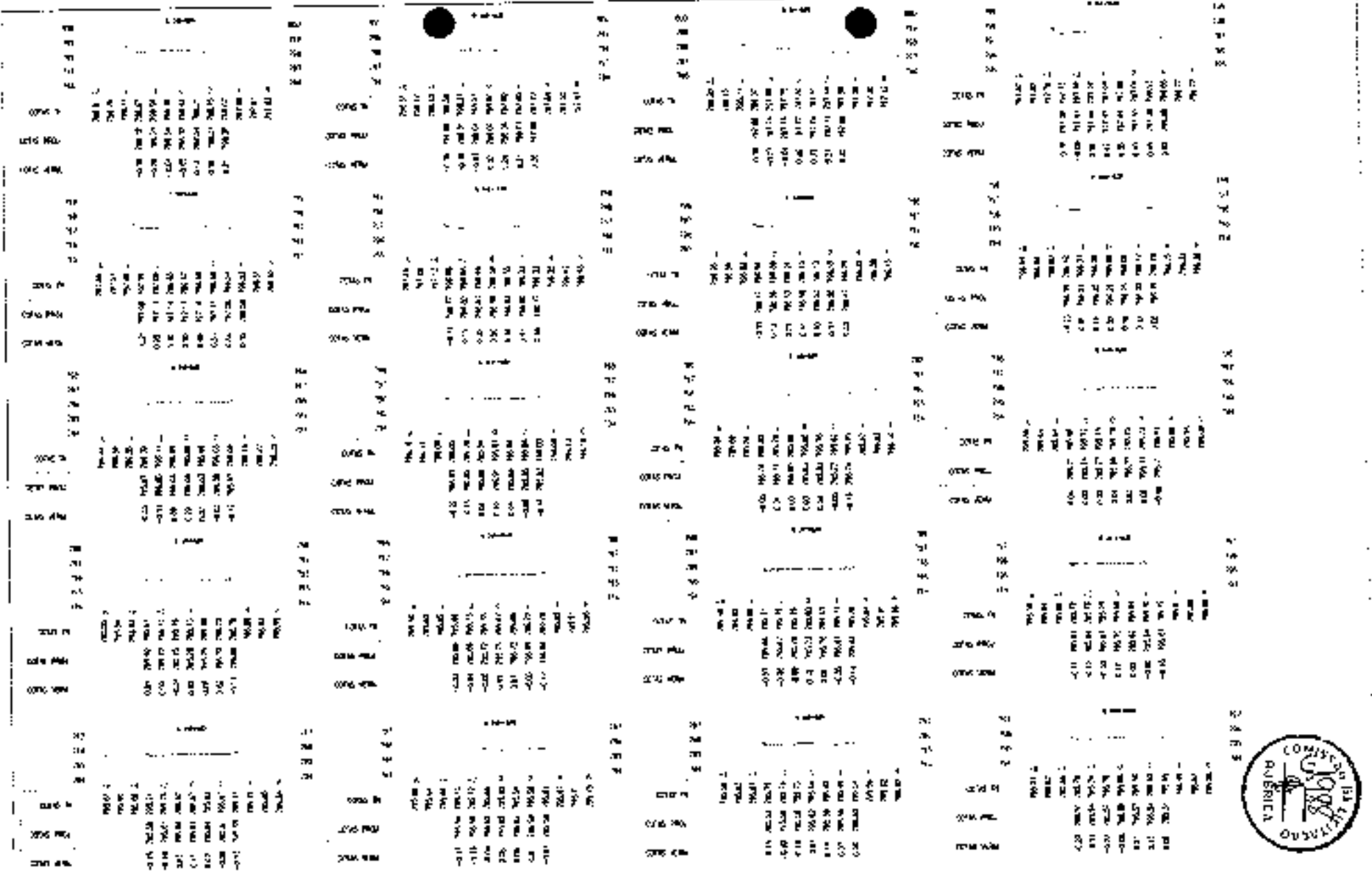

AGÊNCIA

ATERRC
CORTC

1	2	3	4	5	6	7	8	9	10	11	12	13	14	15	16	17	18	19	20	21	22	23	24	25	26	27	28	29	30	31	32	33	34	35	36	37	38	39	40	41	42	43	44	45	46	47	48	49	50	51	52	53	54	55	56	57	58	59	60	61	62	63	64	65	66	67	68	69	70	71	72	73	74	75	76	77	78	79	80	81	82	83	84	85	86	87	88	89	90	91	92	93	94	95	96	97	98	99	100	
100	101	102	103	104	105	106	107	108	109	110	111	112	113	114	115	116	117	118	119	120	121	122	123	124	125	126	127	128	129	130	131	132	133	134	135	136	137	138	139	140	141	142	143	144	145	146	147	148	149	150	151	152	153	154	155	156	157	158	159	160	161	162	163	164	165	166	167	168	169	170	171	172	173	174	175	176	177	178	179	180	181	182	183	184	185	186	187	188	189	190	191	192	193	194	195	196	197	198	199	200

201	202	203	204	205	206	207	208	209	210	211	212	213	214	215	216	217	218	219	220	221	222	223	224	225	226	227	228	229	230	231	232	233	234	235	236	237	238	239	240	241	242	243	244	245	246	247	248	249	250	251	252	253	254	255	256	257	258	259	260	261	262	263	264	265	266	267	268	269	270	271	272	273	274	275	276	277	278	279	280	281	282	283	284	285	286	287	288	289	290	291	292	293	294	295	296	297	298	299	300
-----	-----	-----	-----	-----	-----	-----	-----	-----	-----	-----	-----	-----	-----	-----	-----	-----	-----	-----	-----	-----	-----	-----	-----	-----	-----	-----	-----	-----	-----	-----	-----	-----	-----	-----	-----	-----	-----	-----	-----	-----	-----	-----	-----	-----	-----	-----	-----	-----	-----	-----	-----	-----	-----	-----	-----	-----	-----	-----	-----	-----	-----	-----	-----	-----	-----	-----	-----	-----	-----	-----	-----	-----	-----	-----	-----	-----	-----	-----	-----	-----	-----	-----	-----	-----	-----	-----	-----	-----	-----	-----	-----	-----	-----	-----	-----	-----	-----	-----	-----

301	302	303	304	305	306	307	308	309	310	311	312	313	314	315	316	317	318	319	320	321	322	323	324	325	326	327	328	329	330	331	332	333	334	335	336	337	338	339	340	341	342	343	344	345	346	347	348	349	350	351	352	353	354	355	356	357	358	359	360	361	362	363	364	365	366	367	368	369	370	371	372	373	374	375	376	377	378	379	380	381	382	383	384	385	386	387	388	389	390	391	392	393	394	395	396	397	398	399	400
-----	-----	-----	-----	-----	-----	-----	-----	-----	-----	-----	-----	-----	-----	-----	-----	-----	-----	-----	-----	-----	-----	-----	-----	-----	-----	-----	-----	-----	-----	-----	-----	-----	-----	-----	-----	-----	-----	-----	-----	-----	-----	-----	-----	-----	-----	-----	-----	-----	-----	-----	-----	-----	-----	-----	-----	-----	-----	-----	-----	-----	-----	-----	-----	-----	-----	-----	-----	-----	-----	-----	-----	-----	-----	-----	-----	-----	-----	-----	-----	-----	-----	-----	-----	-----	-----	-----	-----	-----	-----	-----	-----	-----	-----	-----	-----	-----	-----	-----	-----

401	402	403	404	405	406	407	408	409	410	411	412	413	414	415	416	417	418	419	420	421	422	423	424	425	426	427	428	429	430	431	432	433	434	435	436	437	438	439	440	441	442	443	444	445	446	447	448	449	450	451	452	453	454	455	456	457	458	459	460	461	462	463	464	465	466	467	468	469	470	471	472	473	474	475	476	477	478	479	480	481	482	483	484	485	486	487	488	489	490	491	492	493	494	495	496	497	498	499	500
-----	-----	-----	-----	-----	-----	-----	-----	-----	-----	-----	-----	-----	-----	-----	-----	-----	-----	-----	-----	-----	-----	-----	-----	-----	-----	-----	-----	-----	-----	-----	-----	-----	-----	-----	-----	-----	-----	-----	-----	-----	-----	-----	-----	-----	-----	-----	-----	-----	-----	-----	-----	-----	-----	-----	-----	-----	-----	-----	-----	-----	-----	-----	-----	-----	-----	-----	-----	-----	-----	-----	-----	-----	-----	-----	-----	-----	-----	-----	-----	-----	-----	-----	-----	-----	-----	-----	-----	-----	-----	-----	-----	-----	-----	-----	-----	-----	-----	-----	-----

501	502	503	504	505	506	507	508	509	510	511	512	513	514	515	516	517	518	519	520	521	522	523	524	525	526	527	528	529	530	531	532	533	534	535	536	537	538	539	540	541	542	543	544	545	546	547	548	549	550	551	552	553	554	555	556	557	558	559	560	561	562	563	564	565	566	567	568	569	570	571	572	573	574	575	576	577	578	579	580	581	582	583	584	585	586	587	588	589	590	591	592	593	594	595	596	597	598	599	600
-----	-----	-----	-----	-----	-----	-----	-----	-----	-----	-----	-----	-----	-----	-----	-----	-----	-----	-----	-----	-----	-----	-----	-----	-----	-----	-----	-----	-----	-----	-----	-----	-----	-----	-----	-----	-----	-----	-----	-----	-----	-----	-----	-----	-----	-----	-----	-----	-----	-----	-----	-----	-----	-----	-----	-----	-----	-----	-----	-----	-----	-----	-----	-----	-----	-----	-----	-----	-----	-----	-----	-----	-----	-----	-----	-----	-----	-----	-----	-----	-----	-----	-----	-----	-----	-----	-----	-----	-----	-----	-----	-----	-----	-----	-----	-----	-----	-----	-----	-----

601	602	603	604	605	606	607	608	609	610	611	612	613	614	615	616	617	618	619	620	621	622	623	624	625	626	627	628	629	630	631	632	633	634	635	636	637	638	639	640	641	642	643	644	645	646	647	648	649	650	651	652	653	654	655	656	657	658	659	660	661	662	663	664	665	666	667	668	669	670	671	672	673	674	675	676	677	678	679	680	681	682	683	684	685	686	687	688	689	690	691	692	693	694	695	696	697	698	699	700
-----	-----	-----	-----	-----	-----	-----	-----	-----	-----	-----	-----	-----	-----	-----	-----	-----	-----	-----	-----	-----	-----	-----	-----	-----	-----	-----	-----	-----	-----	-----	-----	-----	-----	-----	-----	-----	-----	-----	-----	-----	-----	-----	-----	-----	-----	-----	-----	-----	-----	-----	-----	-----	-----	-----	-----	-----	-----	-----	-----	-----	-----	-----	-----	-----	-----	-----	-----	-----	-----	-----	-----	-----	-----	-----	-----	-----	-----	-----	-----	-----	-----	-----	-----	-----	-----	-----	-----	-----	-----	-----	-----	-----	-----	-----	-----	-----	-----	-----	-----



701	702	703	704	705	706	707	708	709	710	711	712	713	714	715	716	717	718	719	720	721	722	723	724	725	726	727	728	729	730	731	732	733	734	735	736	737	738	739	740	741	742	743	744	745	746	747	748	749	750	751	752	753	754	755	756	757	758	759	760	761	762	763	764	765	766	767	768	769	770	771	772	773	774	775	776	777	778	779	780	781	782	783	784	785	786	787	788	789	790	791	792	793	794	795	796	797	798	799	800
-----	-----	-----	-----	-----	-----	-----	-----	-----	-----	-----	-----	-----	-----	-----	-----	-----	-----	-----	-----	-----	-----	-----	-----	-----	-----	-----	-----	-----	-----	-----	-----	-----	-----	-----	-----	-----	-----	-----	-----	-----	-----	-----	-----	-----	-----	-----	-----	-----	-----	-----	-----	-----	-----	-----	-----	-----	-----	-----	-----	-----	-----	-----	-----	-----	-----	-----	-----	-----	-----	-----	-----	-----	-----	-----	-----	-----	-----	-----	-----	-----	-----	-----	-----	-----	-----	-----	-----	-----	-----	-----	-----	-----	-----	-----	-----	-----	-----	-----	-----

801	802	803	804	805	806	807	808	809	810	811	812	813	814	815	816	817	818	819	820	821	822	823	824	825	826	827	828	829	830	831	832	833	834	835	836	837	838	839	840	841	842	843	844	845	846	847	848	849	850	851	852	853	854	855	856	857	858	859	860	861	862	863	864	865	866	867	868	869	870	871	872	873	874	875	876	877	878	879	880	881	882	883	884	885	886	887	888	889	890	891	892	893	894	895	896	897	898	899	900
-----	-----	-----	-----	-----	-----	-----	-----	-----	-----	-----	-----	-----	-----	-----	-----	-----	-----	-----	-----	-----	-----	-----	-----	-----	-----	-----	-----	-----	-----	-----	-----	-----	-----	-----	-----	-----	-----	-----	-----	-----	-----	-----	-----	-----	-----	-----	-----	-----	-----	-----	-----	-----	-----	-----	-----	-----	-----	-----	-----	-----	-----	-----	-----	-----	-----	-----	-----	-----	-----	-----	-----	-----	-----	-----	-----	-----	-----	-----	-----	-----	-----	-----	-----	-----	-----	-----	-----	-----	-----	-----	-----	-----	-----	-----	-----	-----	-----	-----	-----



	PREFEITURA MUNICIPAL DE GUARACIABA DO NORTE		26 / 73	
	RECUPERAÇÃO DE ESTRADAS VICINAIS NO MUNICÍPIO DE GUARACIABA DO NORTE-CE - FT 08627000		Data	
SEÇÕES TRANSVERSAIS		Assinatura		
PROPOSTA	PROPOSTA Nº 001/2013		Assinatura	
ANEXO	PROPOSTA Nº 001/2013		Assinatura	

LEGENDA

-  ATERRO
-  CORTE

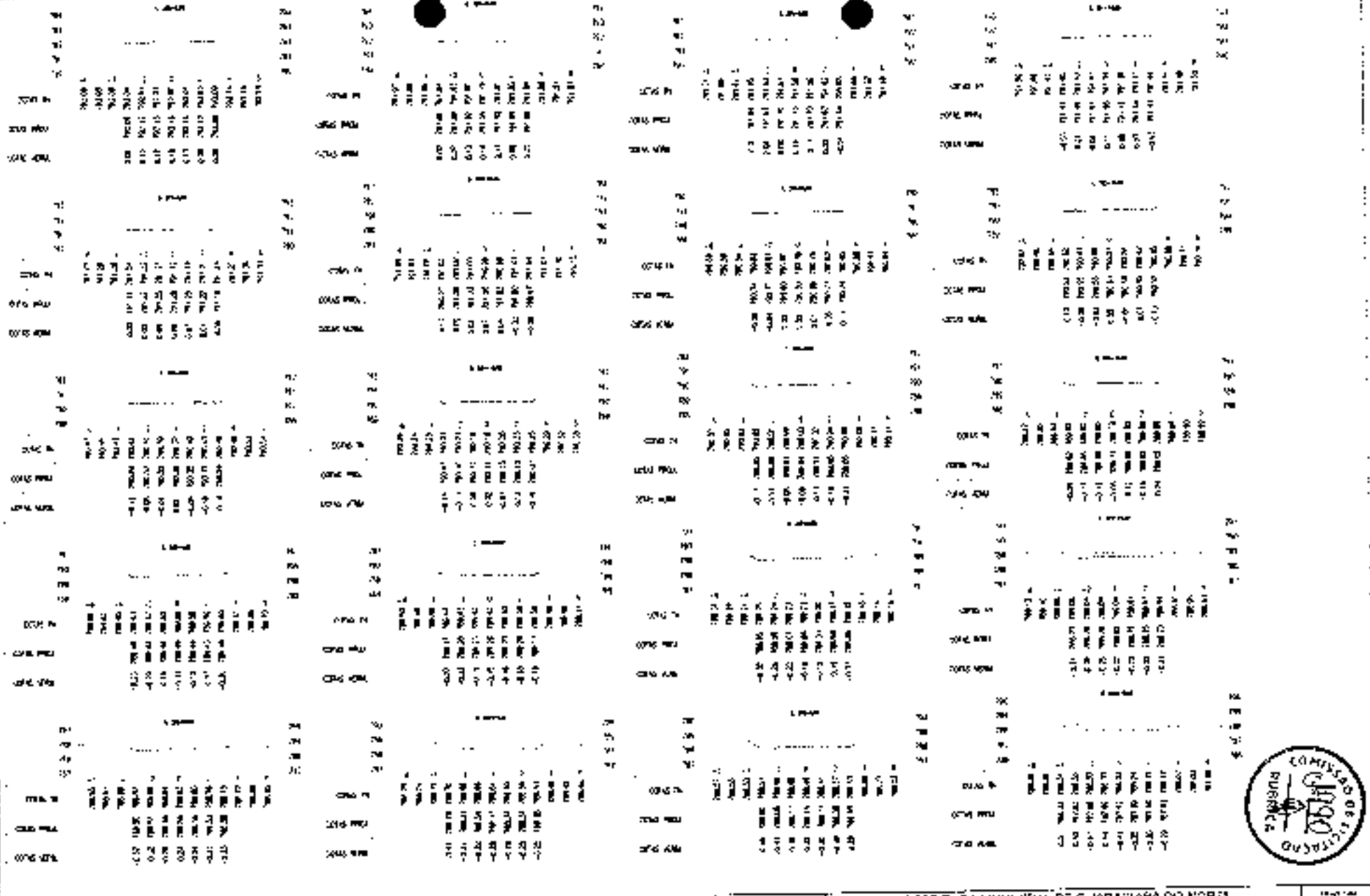

PREFEITURA MUNICIPAL DE GUARAJABA DO NORTE
 REABILITAÇÃO DE ESTRADAS VICINAIS NO MUNICÍPIO DE GUARAJABA DO NORTE-CE - PT 108627D-E3
 SEÇÕES TRANSVERSAIS

PROJETO: EST. DE REABILITAÇÃO DE ESTRADAS VICINAIS
 VOLUME: 01 DE 01 - MAPAS DE SEÇÕES TRANSVERSAIS

27 / 73



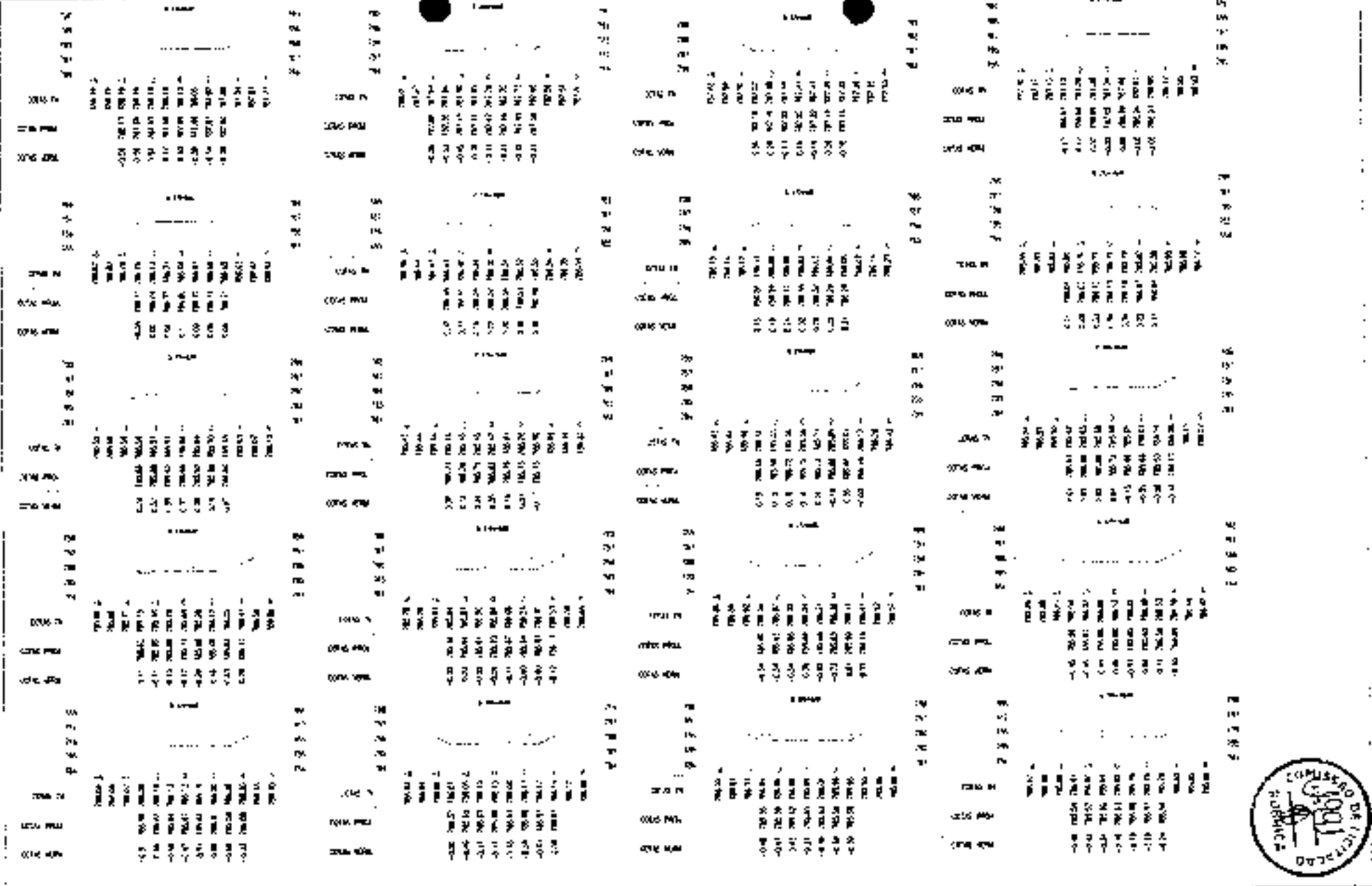

LEGENDA



 ATFRRO

 CORTE

	PREFEITURA MUNICIPAL DE GUARACIABA DO NORTE REGULERAÇÃO DE ESTRADAS VICINAIS NO MUNICÍPIO DE GUARACIABA DO NORTE-CE - PT 10862/0-03 SEÇÕES TRANSVERSAIS		28 / 73
	ALTERNATIVA:	RUA DE GUARACIABA DO NORTE - CANTO NOROCCIDENTAL	
VOLUME:	PLANOS: 10862/0-03/01 A 04		DATA:



LEGENDA

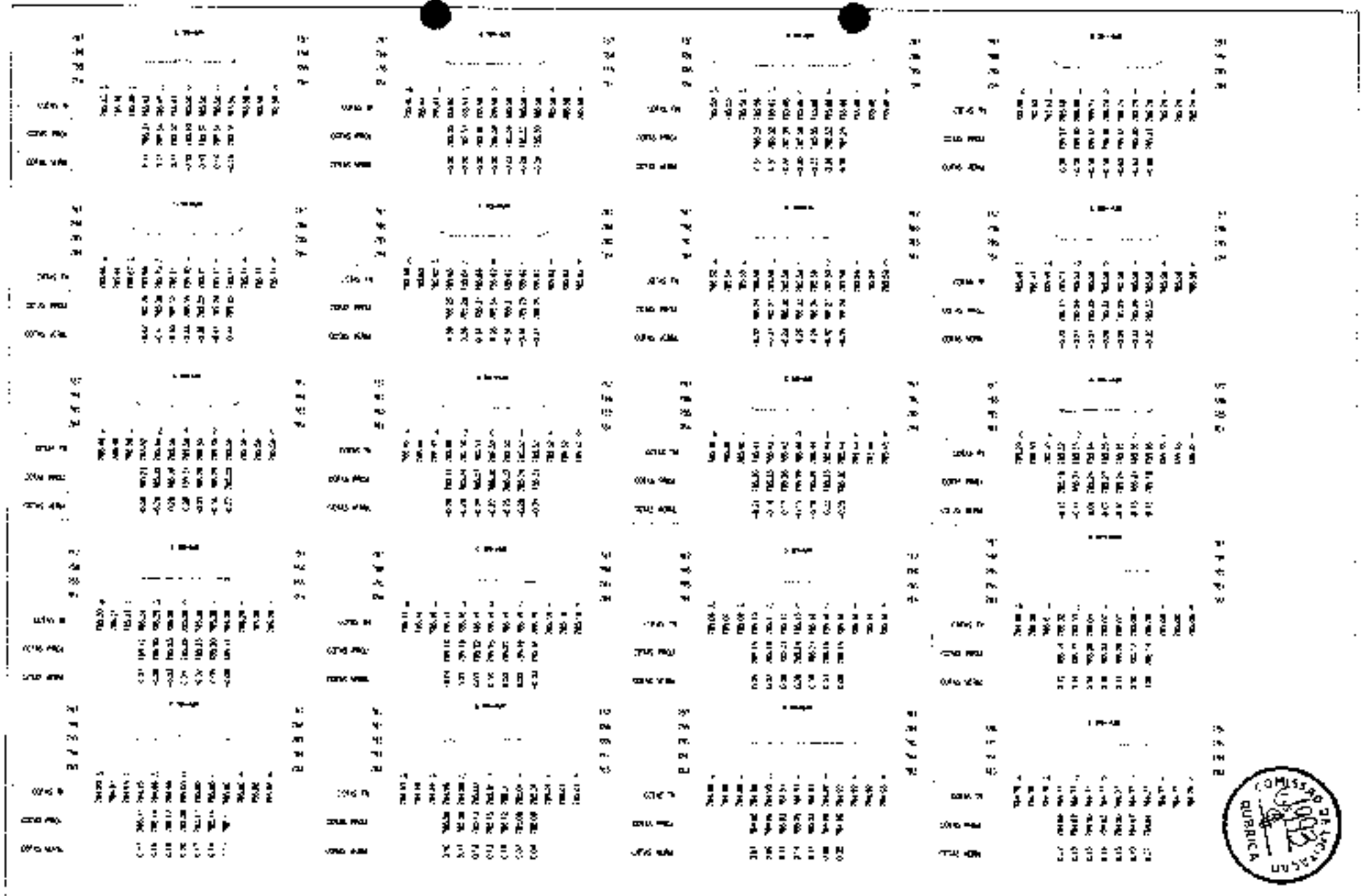

-  ATERRO
-  CORTE





	PREFEITURA MUNICIPAL DE GUARACIABA DO NORTE REABILITAÇÃO DE ESTRADAS VICINAIS NO MUNICÍPIO DE GUARACIABA DO NORTE-CE - PT 1086270-03		Nº 30 / 73
	SEÇÕES TRANSVERSAIS		1:200
	ARQUITETA: DCS CONSULTORIA E PROJETO LTDA - LUIZ CARLOS DE MOURA PROJETO: MCM CONSULTORIA E PROJETO S/A - GUSTAVO S. DE SOUZA		

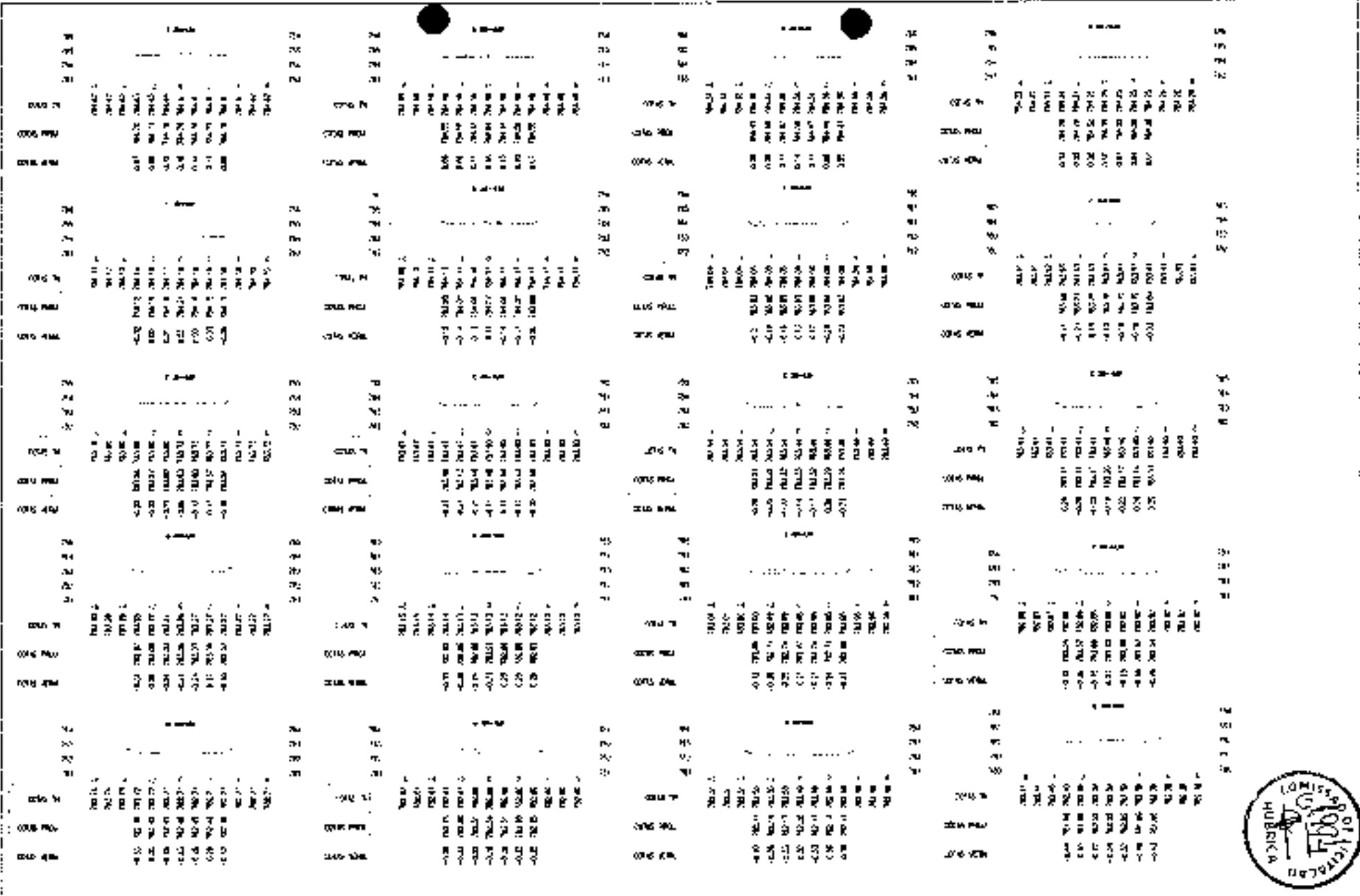

LEGENDA

-  ATERRO
-  CORTA



	PREFEITURA MUNICIPAL DE GUARACIABA DO NORTE RECUPERAÇÃO DE ESTRADAS VICINAIS AO MUNICÍPIO DE GUARACIABA DO NORTE-CE - PI 10862/0-03 SEÇÃO TRANSVERSAIS		31 / 73 1:500
	Nº 001 Nº 002 Nº 003 Nº 004 Nº 005 Nº 006 Nº 007 Nº 008 Nº 009 Nº 010 Nº 011 Nº 012 Nº 013 Nº 014 Nº 015 Nº 016 Nº 017 Nº 018 Nº 019 Nº 020 Nº 021 Nº 022 Nº 023 Nº 024 Nº 025 Nº 026 Nº 027 Nº 028 Nº 029 Nº 030 Nº 031 Nº 032 Nº 033 Nº 034 Nº 035 Nº 036 Nº 037 Nº 038 Nº 039 Nº 040 Nº 041 Nº 042 Nº 043 Nº 044 Nº 045 Nº 046 Nº 047 Nº 048 Nº 049 Nº 050 Nº 051 Nº 052 Nº 053 Nº 054 Nº 055 Nº 056 Nº 057 Nº 058 Nº 059 Nº 060 Nº 061 Nº 062 Nº 063 Nº 064 Nº 065 Nº 066 Nº 067 Nº 068 Nº 069 Nº 070 Nº 071 Nº 072 Nº 073 Nº 074 Nº 075 Nº 076 Nº 077 Nº 078 Nº 079 Nº 080 Nº 081 Nº 082 Nº 083 Nº 084 Nº 085 Nº 086 Nº 087 Nº 088 Nº 089 Nº 090 Nº 091 Nº 092 Nº 093 Nº 094 Nº 095 Nº 096 Nº 097 Nº 098 Nº 099 Nº 100	Nº 001 Nº 002 Nº 003 Nº 004 Nº 005 Nº 006 Nº 007 Nº 008 Nº 009 Nº 010 Nº 011 Nº 012 Nº 013 Nº 014 Nº 015 Nº 016 Nº 017 Nº 018 Nº 019 Nº 020 Nº 021 Nº 022 Nº 023 Nº 024 Nº 025 Nº 026 Nº 027 Nº 028 Nº 029 Nº 030 Nº 031 Nº 032 Nº 033 Nº 034 Nº 035 Nº 036 Nº 037 Nº 038 Nº 039 Nº 040 Nº 041 Nº 042 Nº 043 Nº 044 Nº 045 Nº 046 Nº 047 Nº 048 Nº 049 Nº 050 Nº 051 Nº 052 Nº 053 Nº 054 Nº 055 Nº 056 Nº 057 Nº 058 Nº 059 Nº 060 Nº 061 Nº 062 Nº 063 Nº 064 Nº 065 Nº 066 Nº 067 Nº 068 Nº 069 Nº 070 Nº 071 Nº 072 Nº 073 Nº 074 Nº 075 Nº 076 Nº 077 Nº 078 Nº 079 Nº 080 Nº 081 Nº 082 Nº 083 Nº 084 Nº 085 Nº 086 Nº 087 Nº 088 Nº 089 Nº 090 Nº 091 Nº 092 Nº 093 Nº 094 Nº 095 Nº 096 Nº 097 Nº 098 Nº 099 Nº 100	





82 / 73

PREFEITURA MUNICIPAL DE GUARACIABA DO NORTE
 RECUPERAÇÃO DE ESTRADAS VICINAIS NO MUNICÍPIO DE GUARACIABA DO NORTE - RJ - PT. 008270-03
 BLOCOS TRANSVERSAIS



PROJETO DE ARQUITETURA E LAYOUT DE PAVIMENTAÇÃO
 ELABORADO POR: JOTA BARROS
 ENDEREÇO: RUA ...

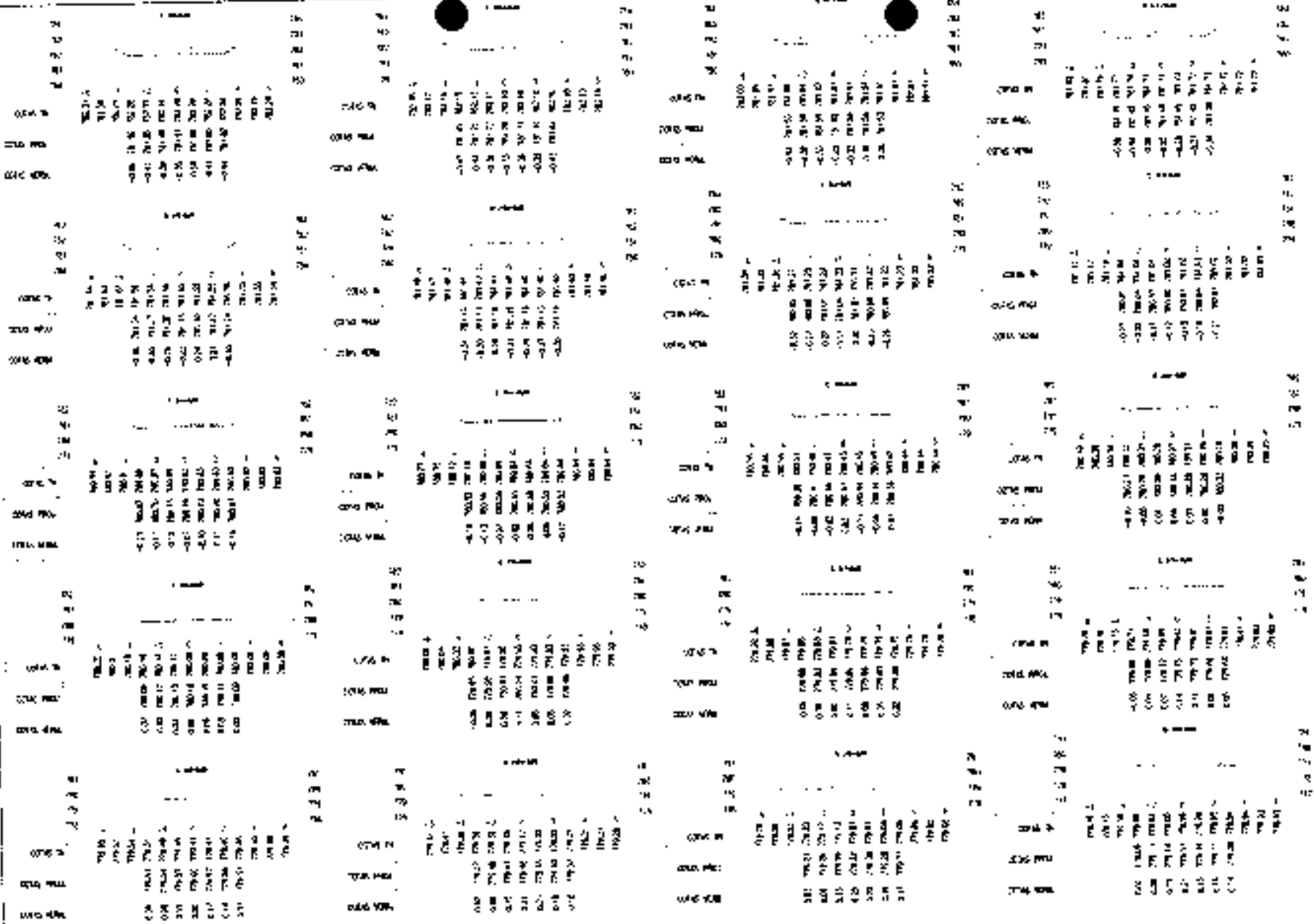

LEGENDA

- ALBERGO
- CURTE

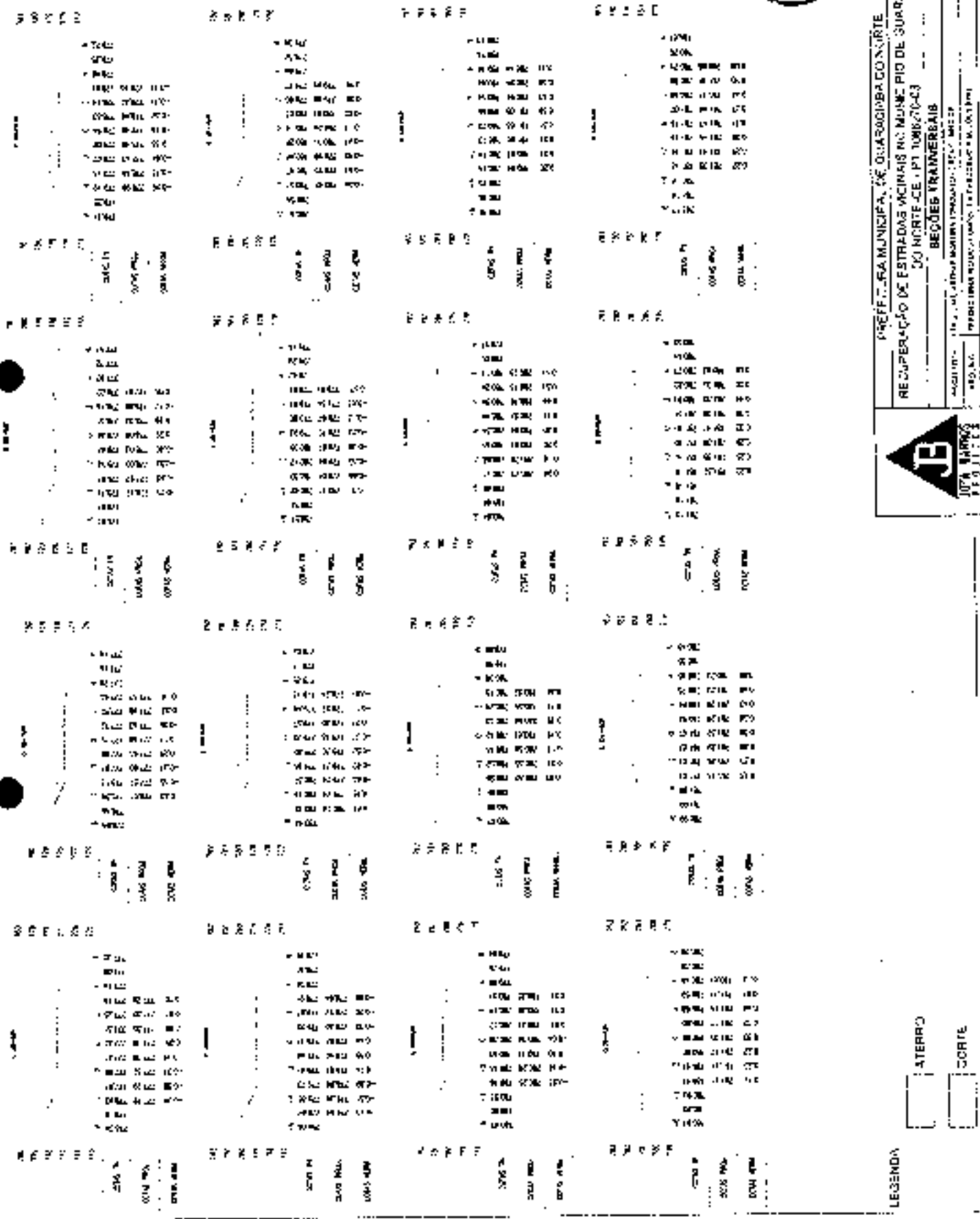

LEGENDA

ATERRO

CORTE



PROF. RAJAMUNICIPA DE QUARACIABA CONJUNTO
 RECUPERAÇÃO DE ESTRADAS VICINAIS NO MUNICÍPIO DE QUARACIABA
 30 NORTE-CE-PT 108670-03
 BLOCOS TRANSVERSAIS

ATA Nº 01 - 1ª FASE - ABERTURA MATERIAL PROPOSTAS - 25/07/97
 PUBLICADO EM 25/07/97 - Nº 01/97

34/97

LEGENDA

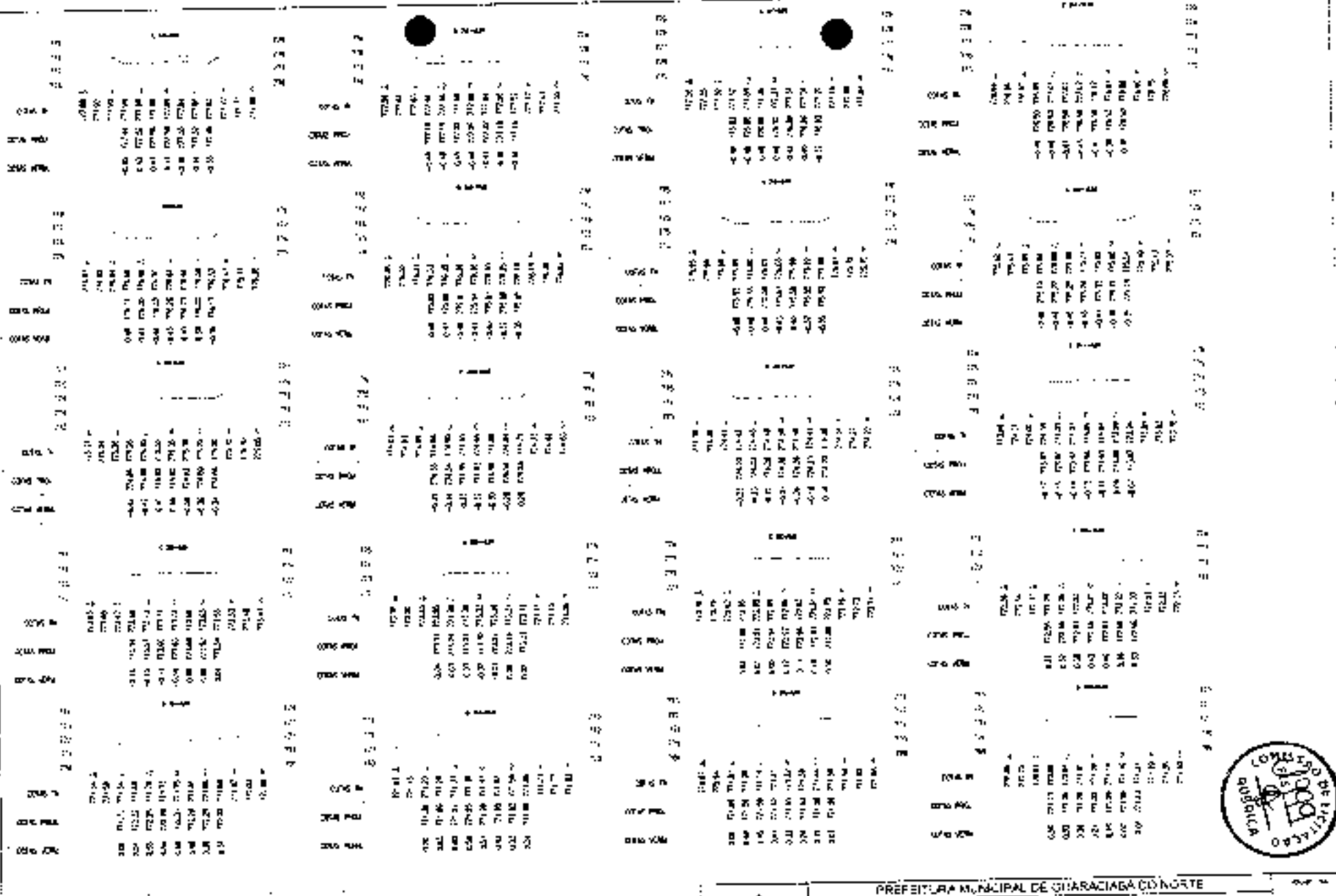
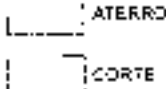



PREFEITURA MUNICIPAL DE GUARACIABA DO NORTE
 RECUPERAÇÃO DE ESTRADAS VICINAIS NO MUNICÍPIO DE GUARACIABA DO NORTE-CE - P1 1086274-03
 SEÇÕES TRANSVERSAIS

36 / 72
 1/250



LEGENDA

-  ATERRO
-  COARTE

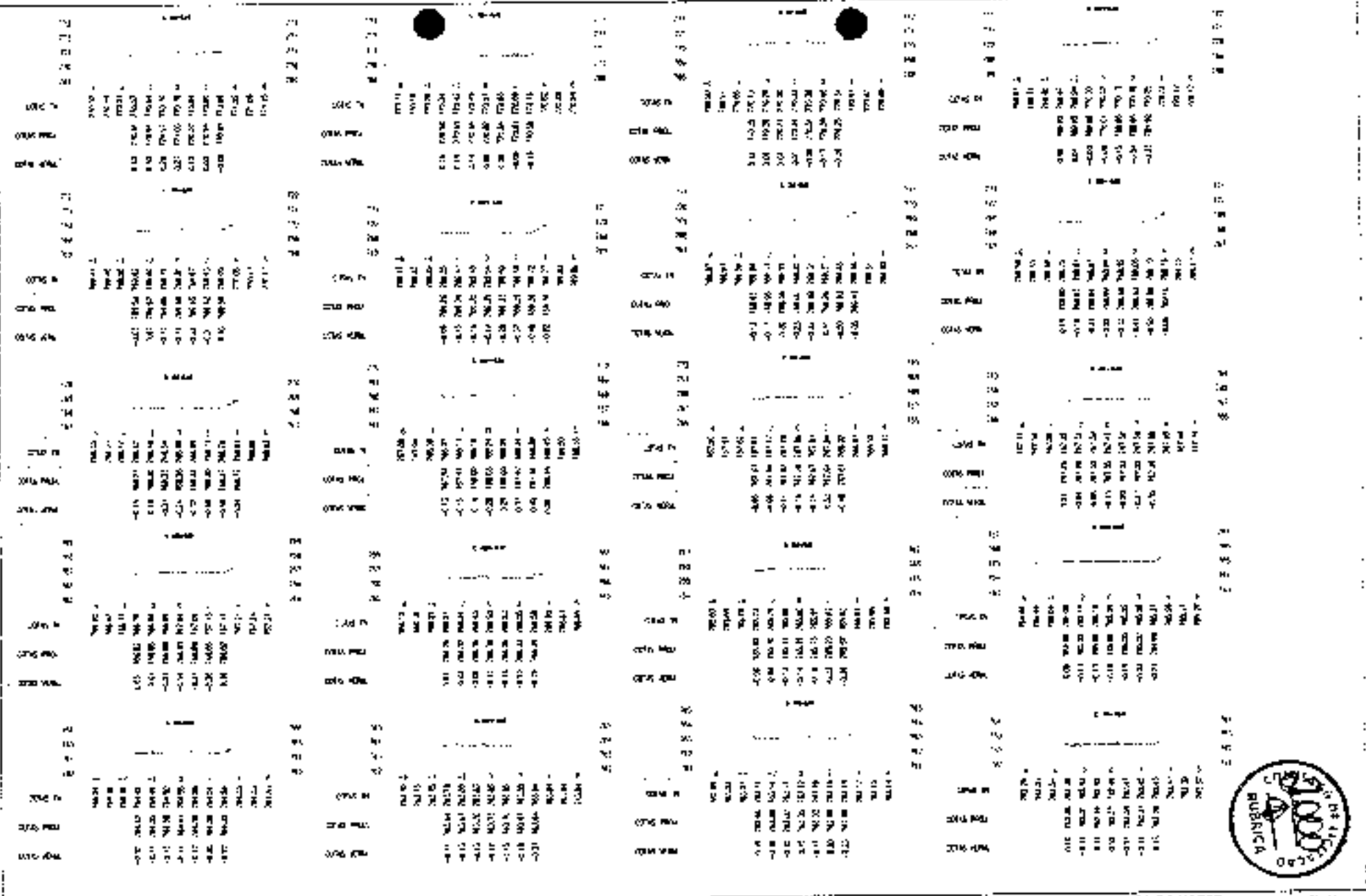

 <p>JOTA BARROS PROJETOS</p>	<p>PREFEITURA MUNICIPAL DE GUARACIABA DO NORTE</p> <p>RECUPERAÇÃO DE ESTRADAS VICINAIS NO MUNICÍPIO DE GUARACIABA DO NORTE - CE - PT 1386270-00</p> <p>SEÇÕES TRANSVERSAIS</p>		<p>37 / 73</p>
	<p>PROJETO: RECUPERAÇÃO DE ESTRADAS VICINAIS NO MUNICÍPIO DE GUARACIABA DO NORTE - CE - PT 1386270-00</p> <p>FECHA: 20/08/2014</p>	<p>PROJETO: RECUPERAÇÃO DE ESTRADAS VICINAIS NO MUNICÍPIO DE GUARACIABA DO NORTE - CE - PT 1386270-00</p> <p>FECHA: 20/08/2014</p>	



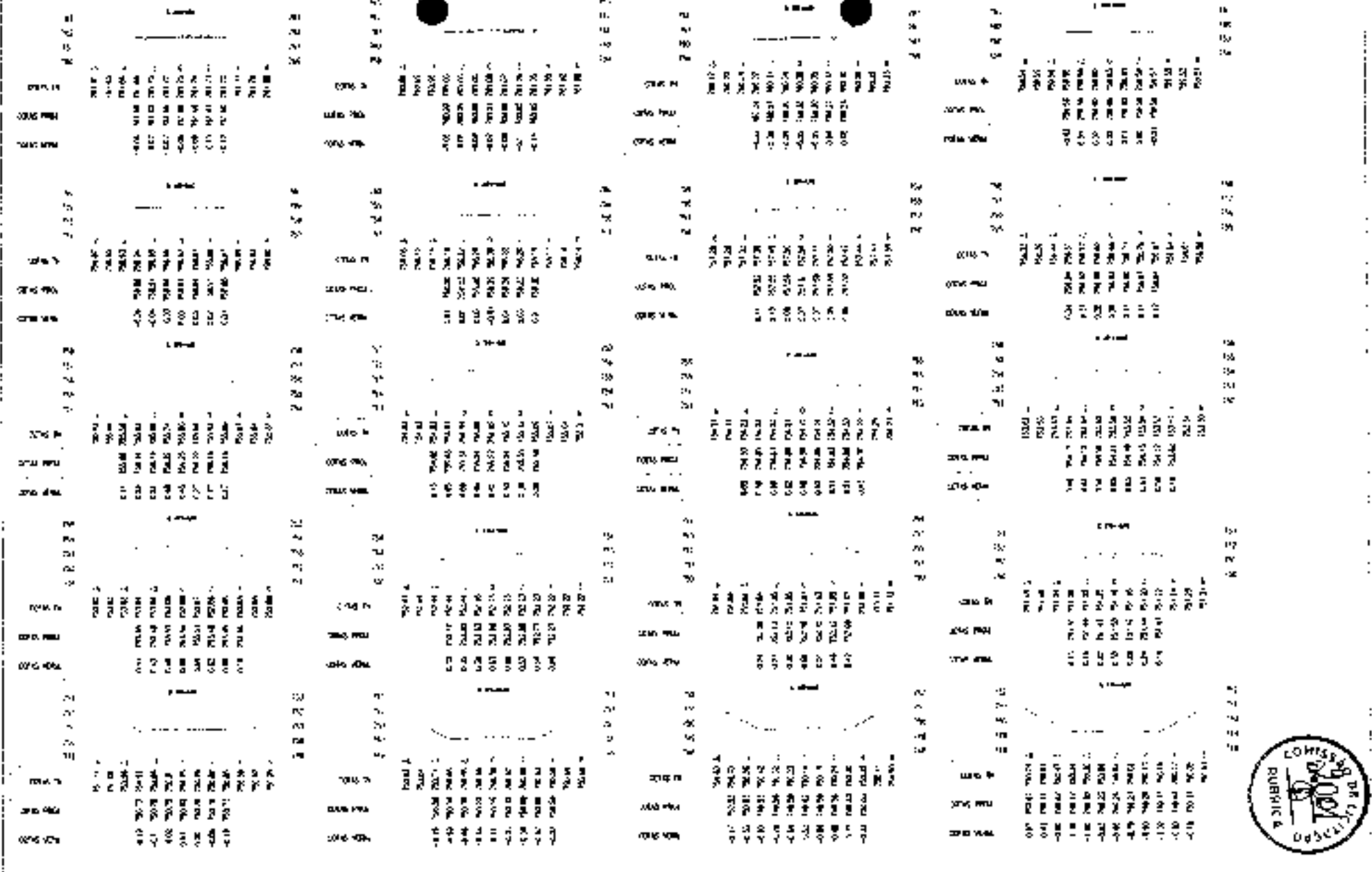

	PREFEITURA MUNICIPAL DE GUARACIABA DO NORTE RECUPERAÇÃO DE ESTRADAS VICINAIS NO MUNICÍPIO DE GUARACIABA DO NORTE-CE - P.º 108527003		38 / 73 <small>1984</small> 1984
	SEÇÕES TRANSVERSAIS		
<small>PROJETO</small> <small>EXECUÇÃO</small>	<small>ENG.º CIVIL</small> JOÃO BARROS <small>PROJETO</small> <small>PROF.º</small> JOÃO BARROS <small>EXECUÇÃO</small>		<small>1984</small> 1984

LEGENDA

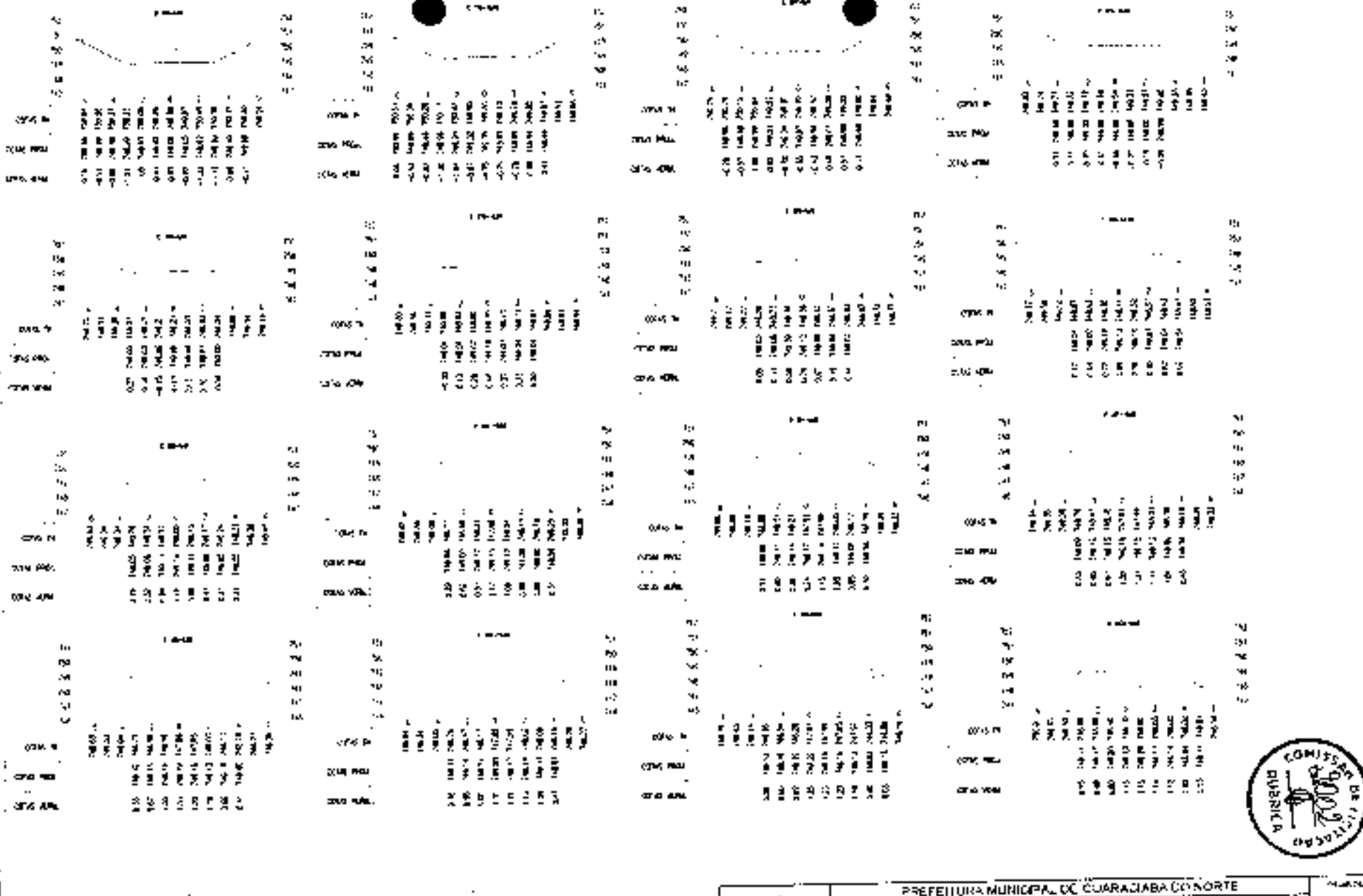

- A'ERRO
- CIRTE



<p>Jofa Barros PRECILIOS</p>	<p>PREFEITURA MUNICIPAL DO GUARACIABA DO NORTE</p> <p>RECUPERAÇÃO DE ESTADAS VICINAIS NO MUNICÍPIO DE GUARACIABA DO NORTE - CE - PI 1008270-03</p> <p>SEÇÕES TRANSVERSAIS</p>		<p>39 / 73</p>
	PROJETA	DES. LUIZ ANTÔNIO MOURA FERREIRA - CRP 14.188/07	
	APROVA	MUNICÍPIO: GUARACIABA DO NORTE - PIAUÍ - BRASIL	



LEGENDA

-  ATERRO
-  CORTE

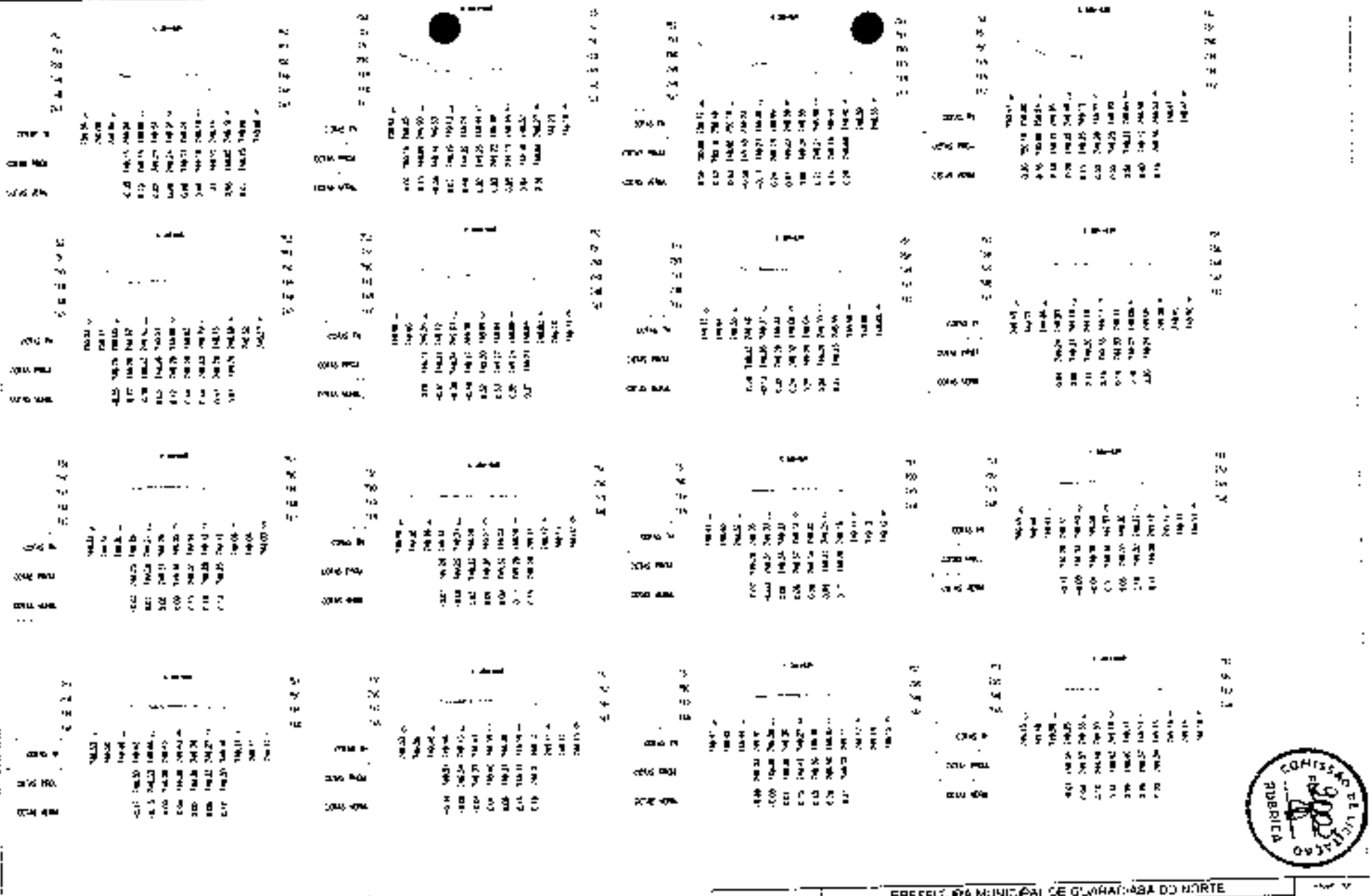

PREFEITURA MUNICIPAL DE GUARACIAMA DO NORTE RECUPERAÇÃO DE ESTRADAS VICIAIS NO MUNICÍPIO DE GUARACIAMA DO NORTE-CE - PT. 1085200-00 SEÇÕES TRANSVERSAIS		Nº 40/73 DATA 1957
PROJETO	PROJ. DE ART. DE MONTE TOPOGRÁFICO E PLANIMÉTRICO	
ARGUMENTO	RECUPERAÇÃO DE ESTRADAS VICIAIS E DE BARRAGENS DE LINDO	

LEGENDA

ATERRO

CORTE

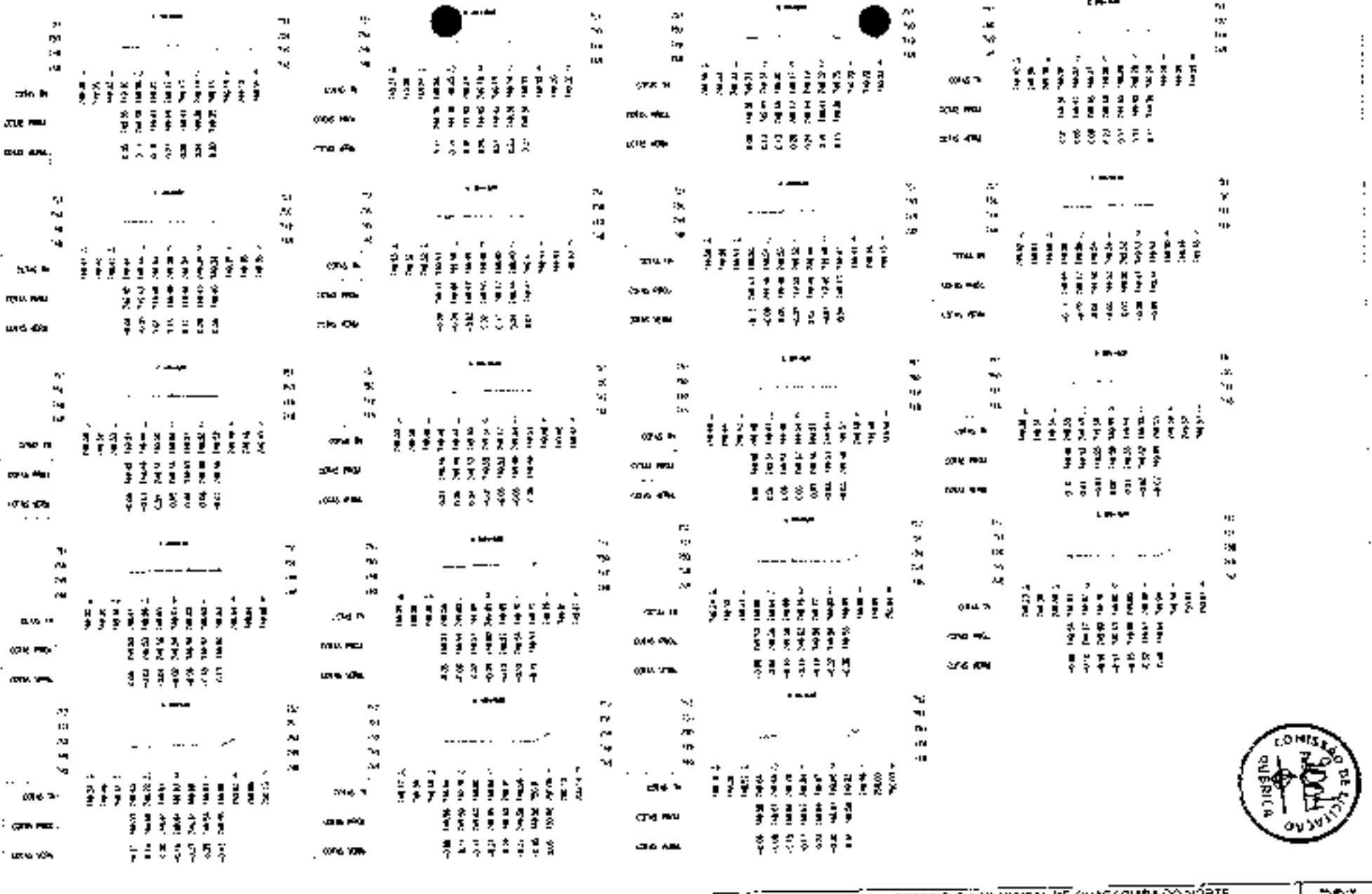

PREFEITURA MUNICIPAL DE GUARACIABA DO NORTE
 RECUPERAÇÃO DE ESTRADAS VINDAIS NO MUNICÍPIO DE GUARACIABA
 CC NORTE-CE - PT 1006270-03
 SEÇÕES TRANSVERSAIS

COORDENADOR: DR. CARLOS ALBERTO MOURA FERREIRA - ENGENHEIRO
 ARQUIVADO: PAULO ROBERTO DOS REIS SILVA - ENGENHEIRO DE CIVIL

41/73
 CBR



LEGENÇA

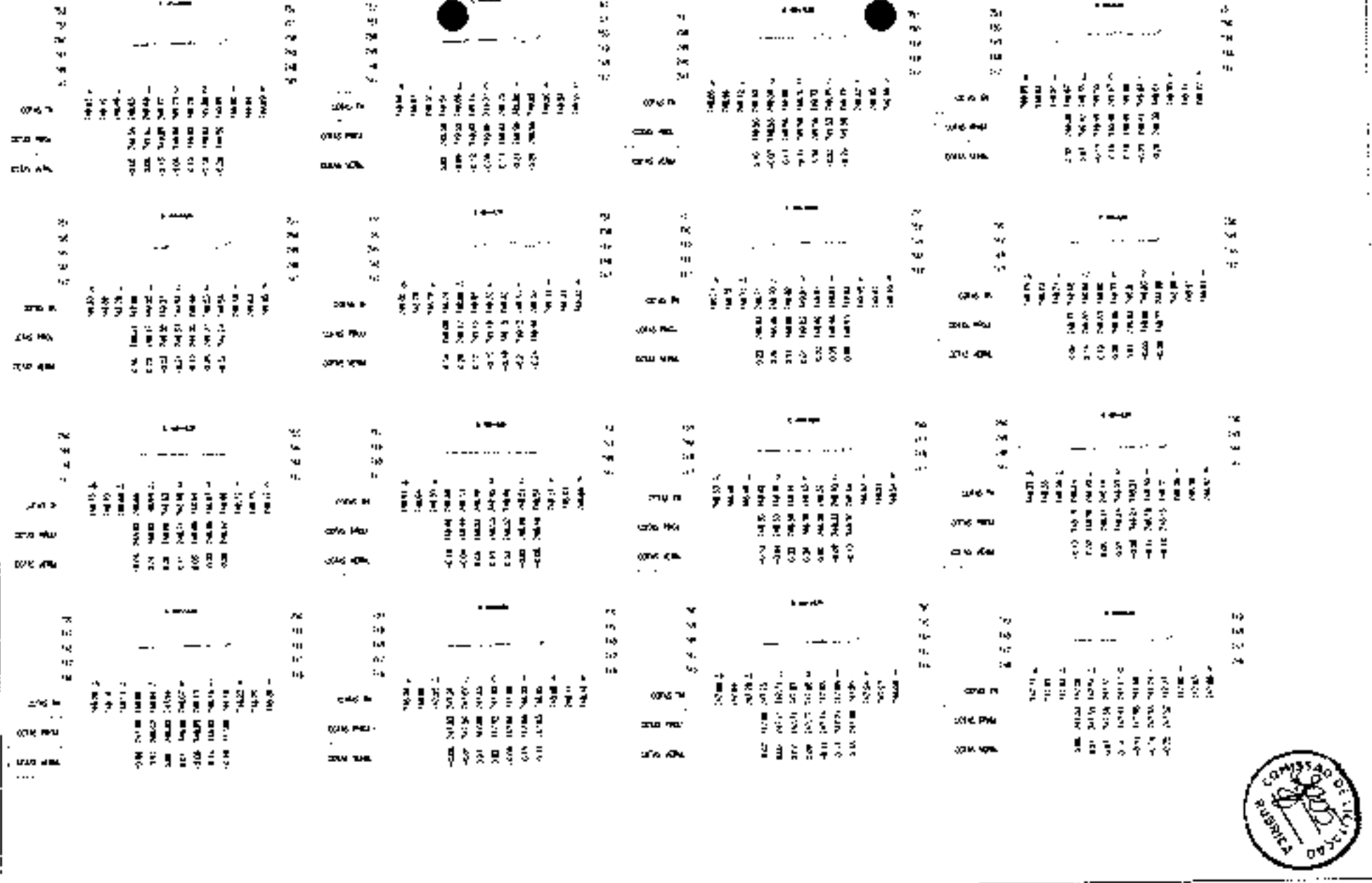
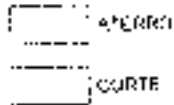

PREFEITURA MUNICIPAL DE GUARACIABA DO NORTE
 RECUPERAÇÃO DE ESTRADAS VICIAIS NO MUNICÍPIO DE GUARACIABA DO NORTE-CE - PI 1088270-03
 SEÇÕES TRANSVERSAIS

42173
 2



LEGENDA

- ATERRO
- CORTE

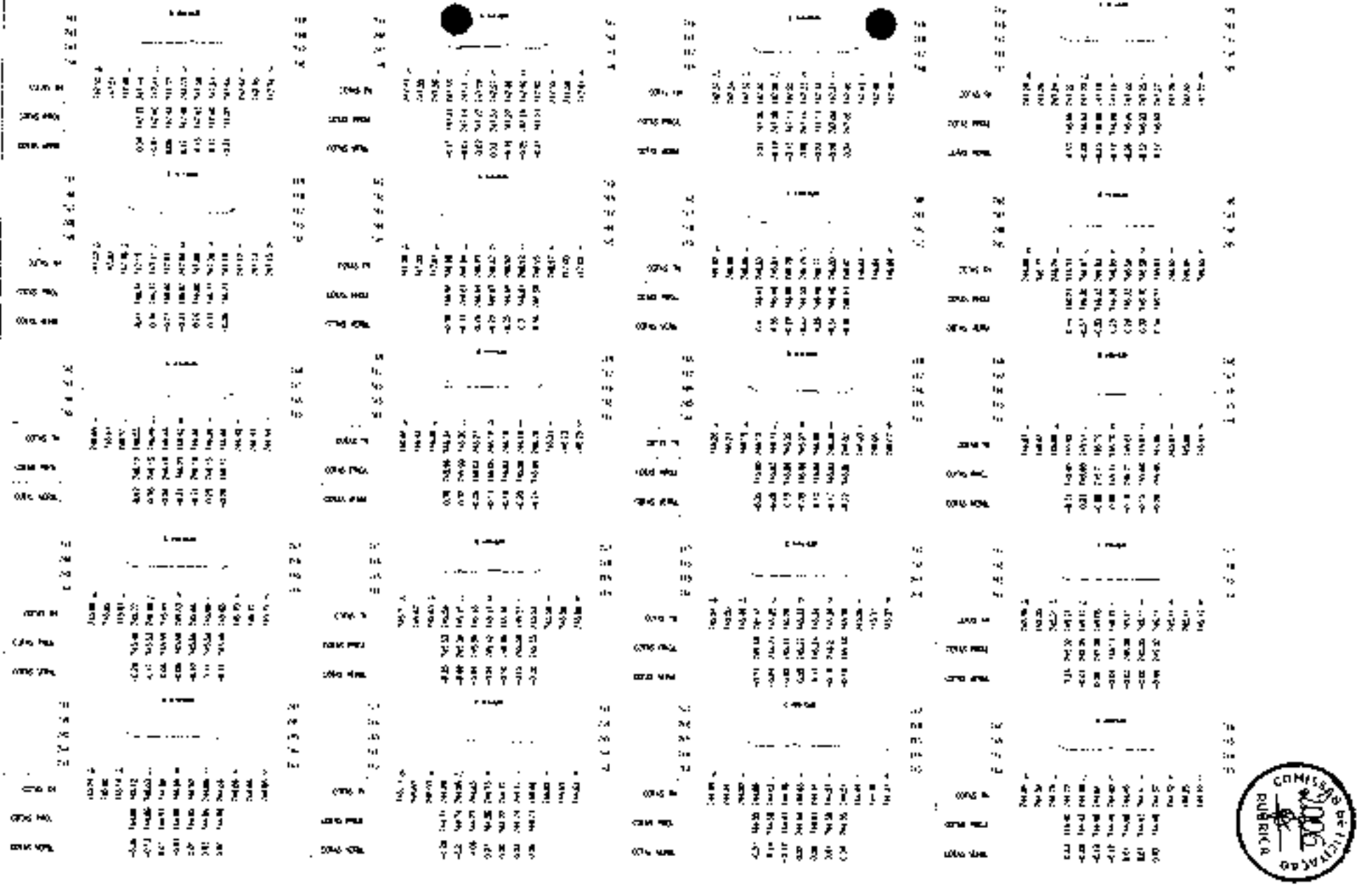

PREFEITURA MUNICIPAL DE GUARACIABA DO NORTE
 RECLPERAÇÃO DE ESTRADAS VICINAIS NO MUNICÍPI DO GUARACIABA DO NORTE-CE - PT 100324D-00
 SEÇÕES TRANSVERSAIS

43 / 73

PROJETO: RECLPERAÇÃO DE ESTRADAS VICINAIS NO MUNICÍPI DO GUARACIABA DO NORTE-CE - PT 100324D-00
 AUTORIZADO: [Assinatura]





PREFEITURA MUNICIPAL DE GUARACIABA DO NORTE RECUPERAÇÃO DE ESTRADAS VICINAIS NO MUNICÍPIO DE GUARACIABA DO NORTE-CE - PT 1005270-03 SEÇÃO TRANSVERSAIS		44173 10256
Rua C/034 Avenida L. de Sá, 1000 - Fátima - Fortaleza - CE CEP: 60010-000	TEL: (85) 3101-8000 FAX: (85) 3101-8001	

LEGENDA

ATERRO
 CORTIL

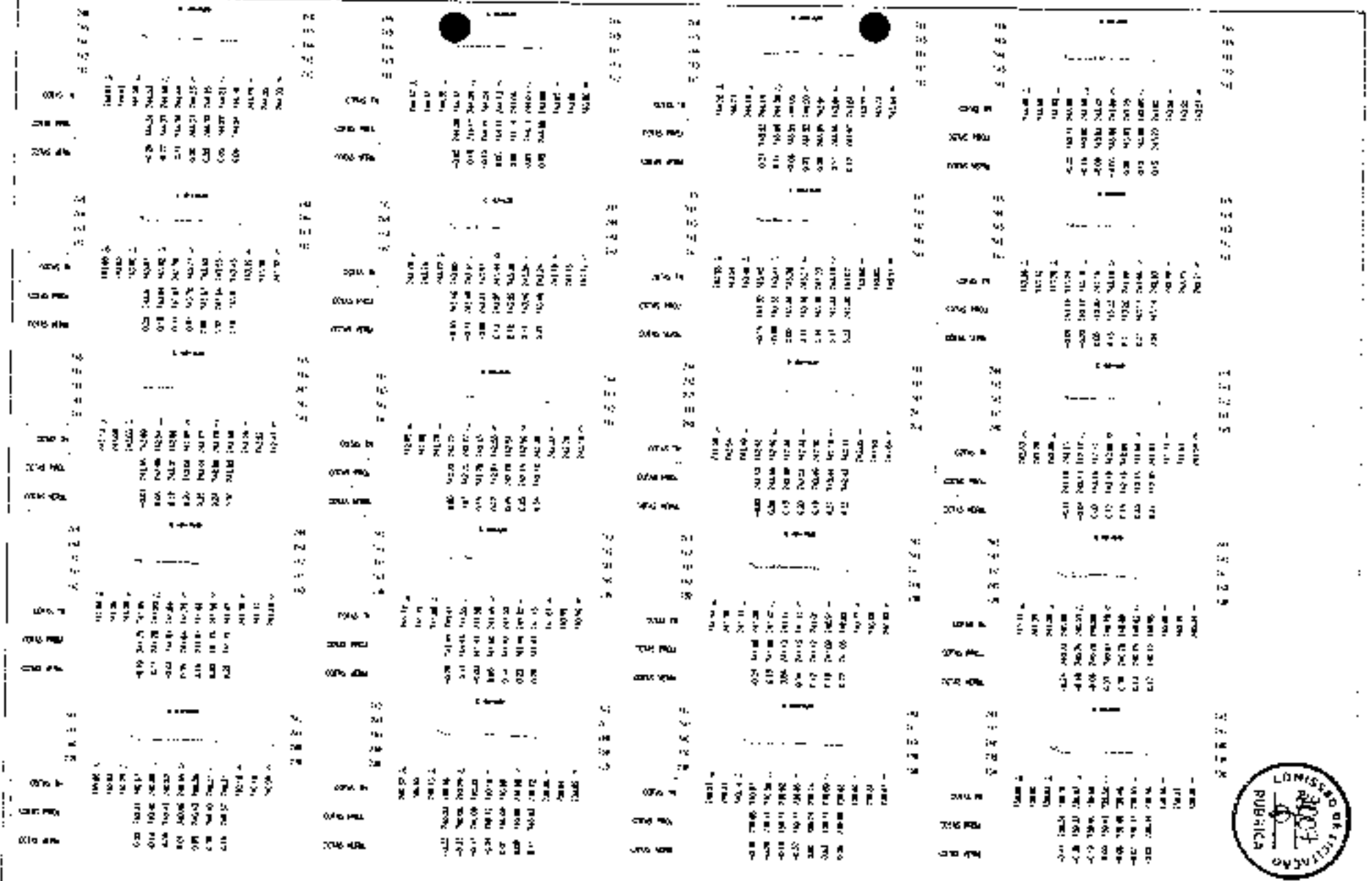



PREFEITURA MUNICIPAL DE GUARACIABA DO NORTE
 RECUPERAÇÃO DE ESTRADAS VICINAIS NO MUNICÍPIO DE GUARACIABA DO NORTE - GE - PT 109-270-00
 BÊÇOS TRANSVERSAIS



PROPOSTA Nº 001/2000
 VALOR R\$ 1.250,00

45 / 73
 1.250

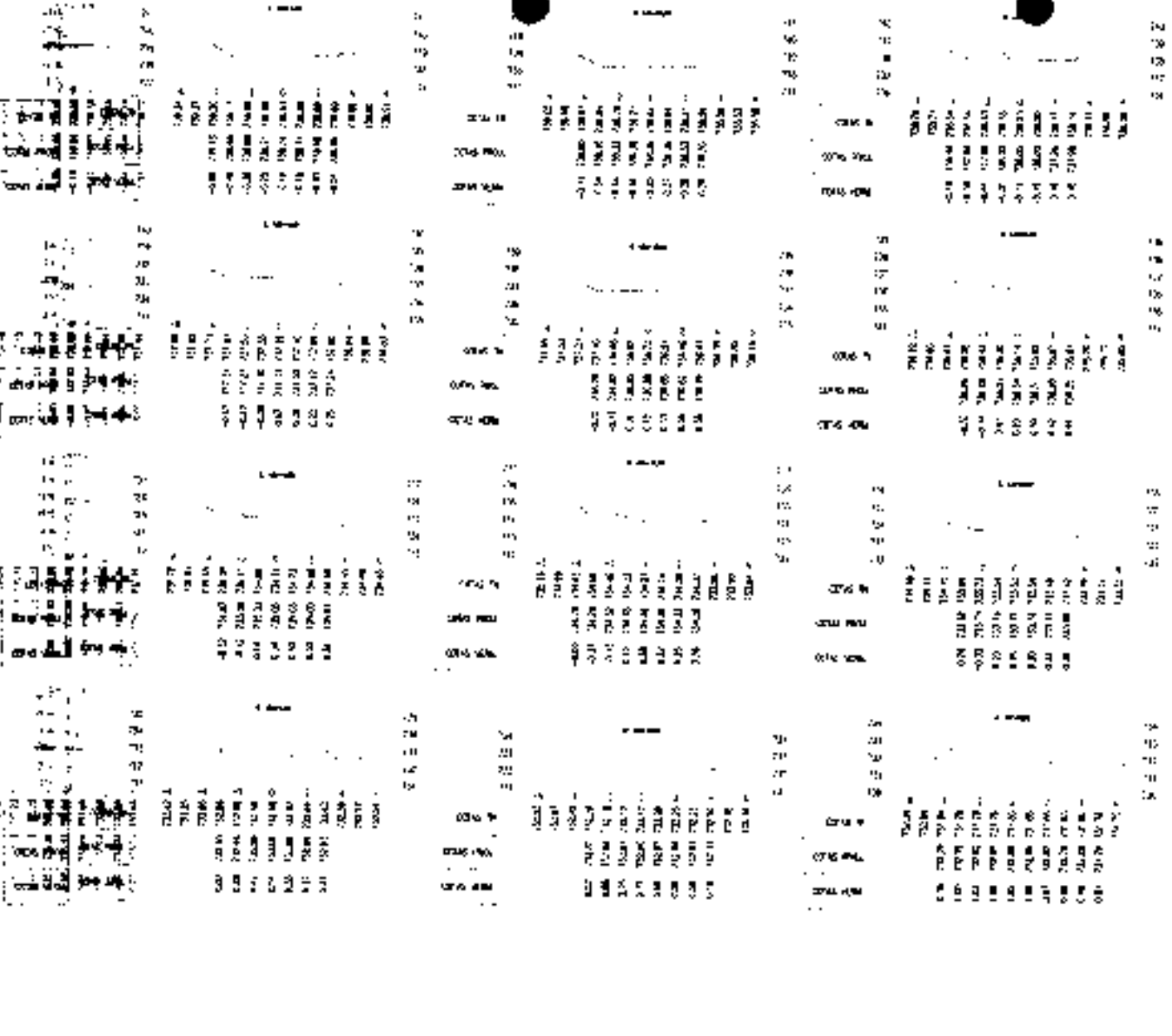
LEGENDA



LEGENDA

-  ATERRO
-  CORTES

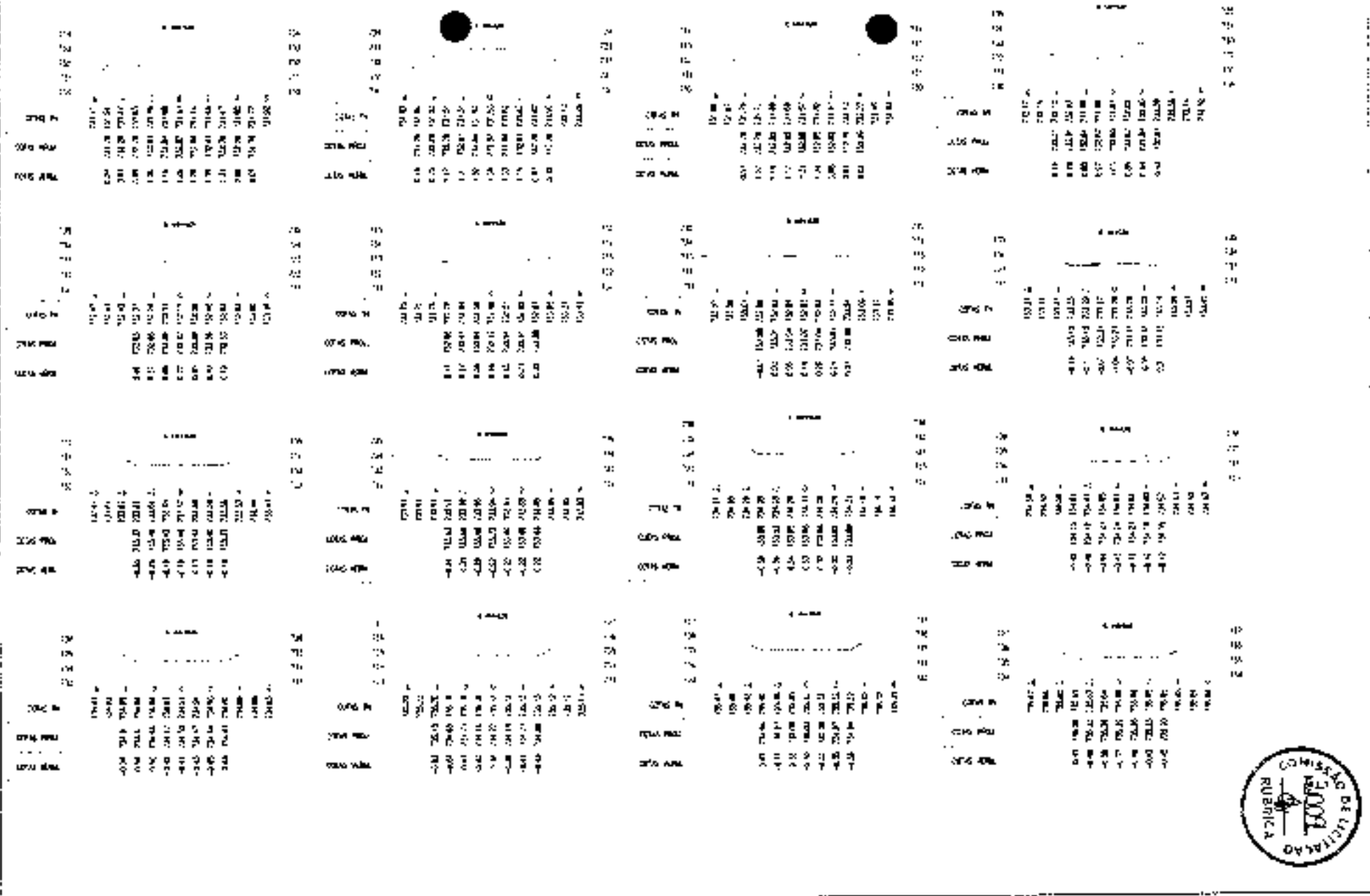



JOÃO BARROS
ENGENHARIA

PREFEITURA MUNICIPAL DE GUARACIABA DO NORTE

RECUPERAÇÃO DE ESTRAÇAS VICINAIS NO MUNICÍPIO DE GUARACIABA DO NORTE-CE - PT 1.062720-00

SEÇÕES TRANSVERSAIS

MATERIAL	MOL. C/VA. 100% C/VA. 100% C/VA. 100% C/VA. 100%	
APROX.	TERRA. 100% C/VA. 100% C/VA. 100% C/VA. 100%	

46 / 73

1:250



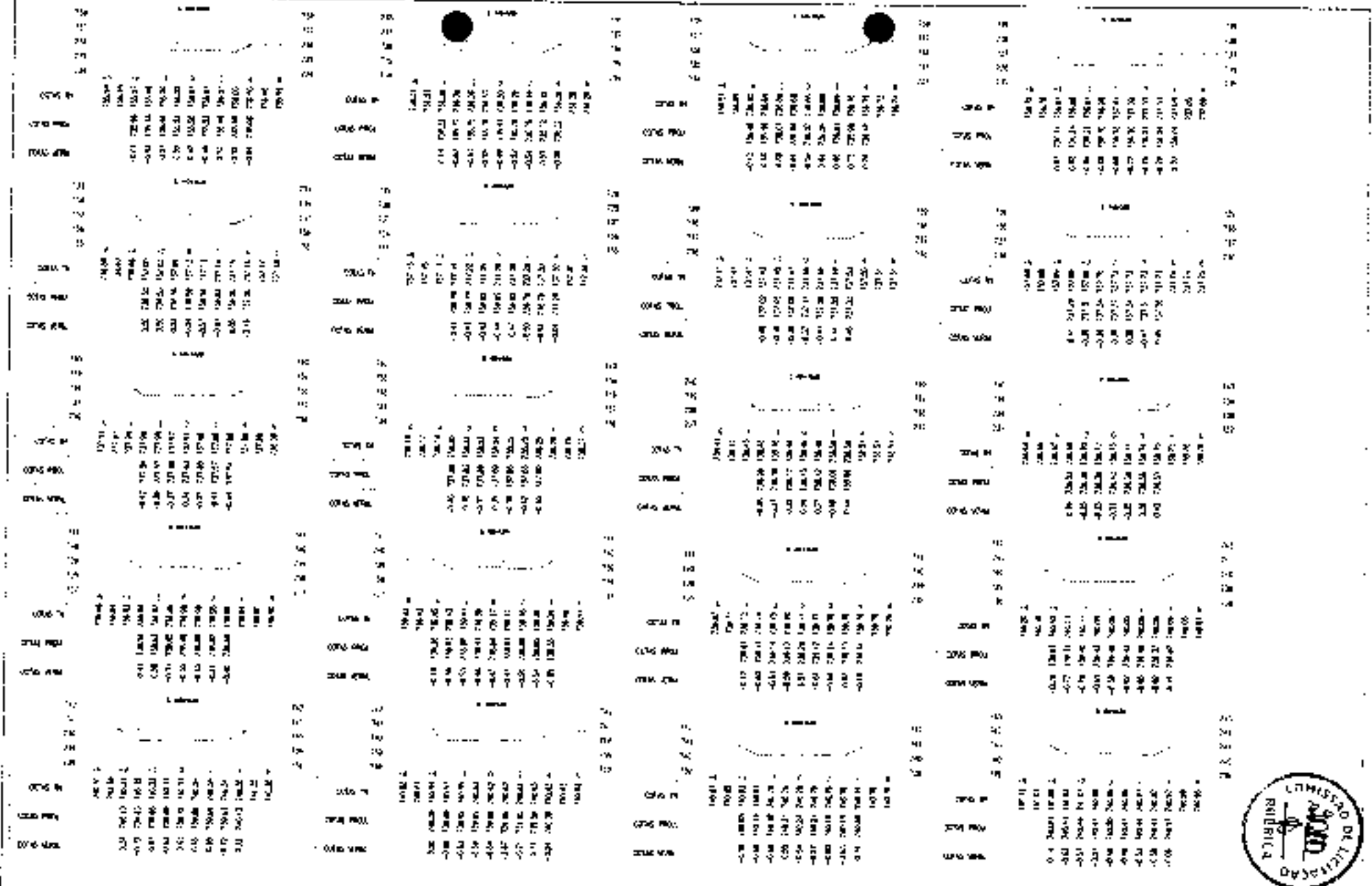

LEGENDA

ATERRO

CORTE



PREFEITURA MUNICIPAL DE GLARACABA DO NORTE

RECUPERAÇÃO DE ESTRADAS VICINAIS NO MUNICÍPIO DE GUARACIABA

CO-NORTE-CE - PT 10R627043

SEÇÕES TRANSVERSAIS

PROJETO	10R627043
DATA	10/2006
ESCALA	1:500
PROJETO	10R627043
DATA	10/2006
ESCALA	1:500

47 / 73

1/250



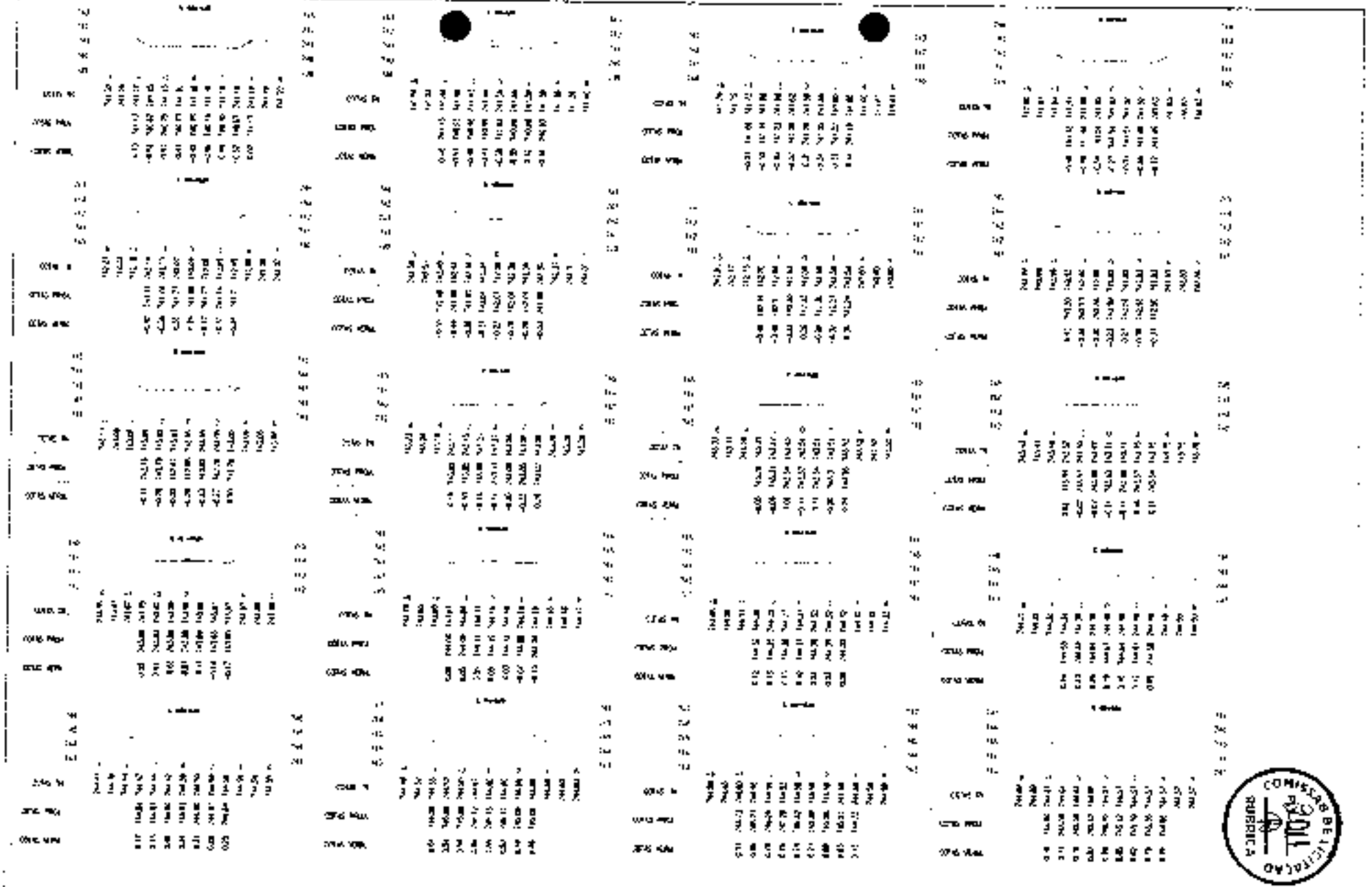

LEGENDA

ATERRO
CORTE



PREFEITURA MUNICIPAL DE GUARACIABA DO NORTE RECUPERAÇÃO DE ESTRADAS VICINAIS NO MUNICÍPIO DE GUARACIABA DO NORTE-CE - P.º 1085700-3 SEÇÕES TRANSVERSAIS		48 / 73
PROJETO	ENG. LUIZ CARLOS ROCHA FERREIRA - CREA 10780/00	1954
ÁREA	PROF. CARLOS JOSÉ FERREIRA - CREA 10780/00	





48 / 73

PREFEITURA MUNICIPAL DE GUARACIABA DO NORTE
 RECUPERAÇÃO DE ESTRADAS VICINAIS NO MUNICÍPIO DE GUARACIABA DO NORTE - CE - PT 1686270-03
 SEÇÃO TRANSVERSAIS

PROJ. ENG. CIVIL: MARCELO TORRES L. - CREA 12889/21
 TÍTULO: LANCAMENTO DE PONTÃO NA LAVAGEM SECCIONADA





LEGENDA

□ ATERRO

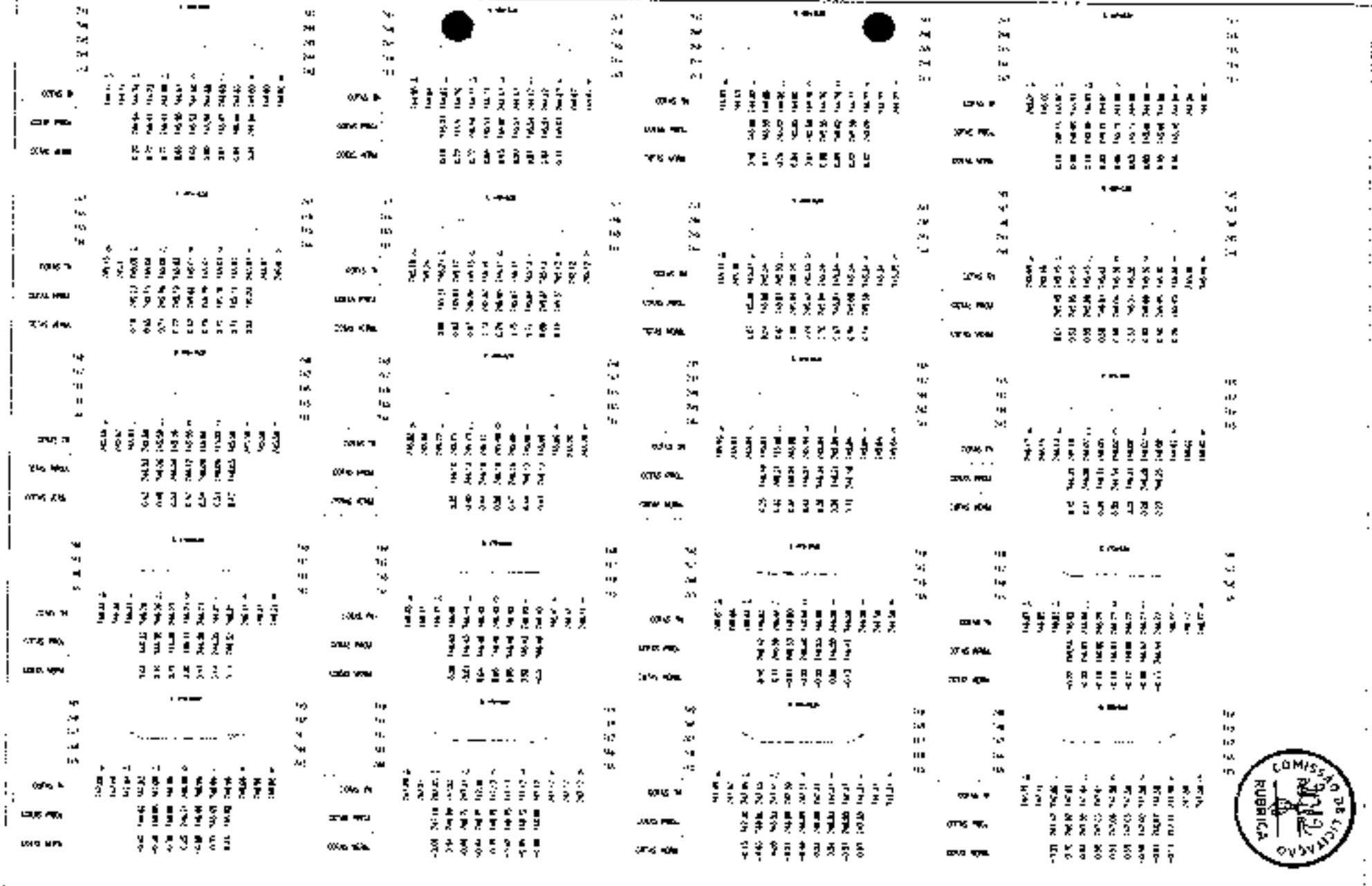
□ CORTE



LEGENDA

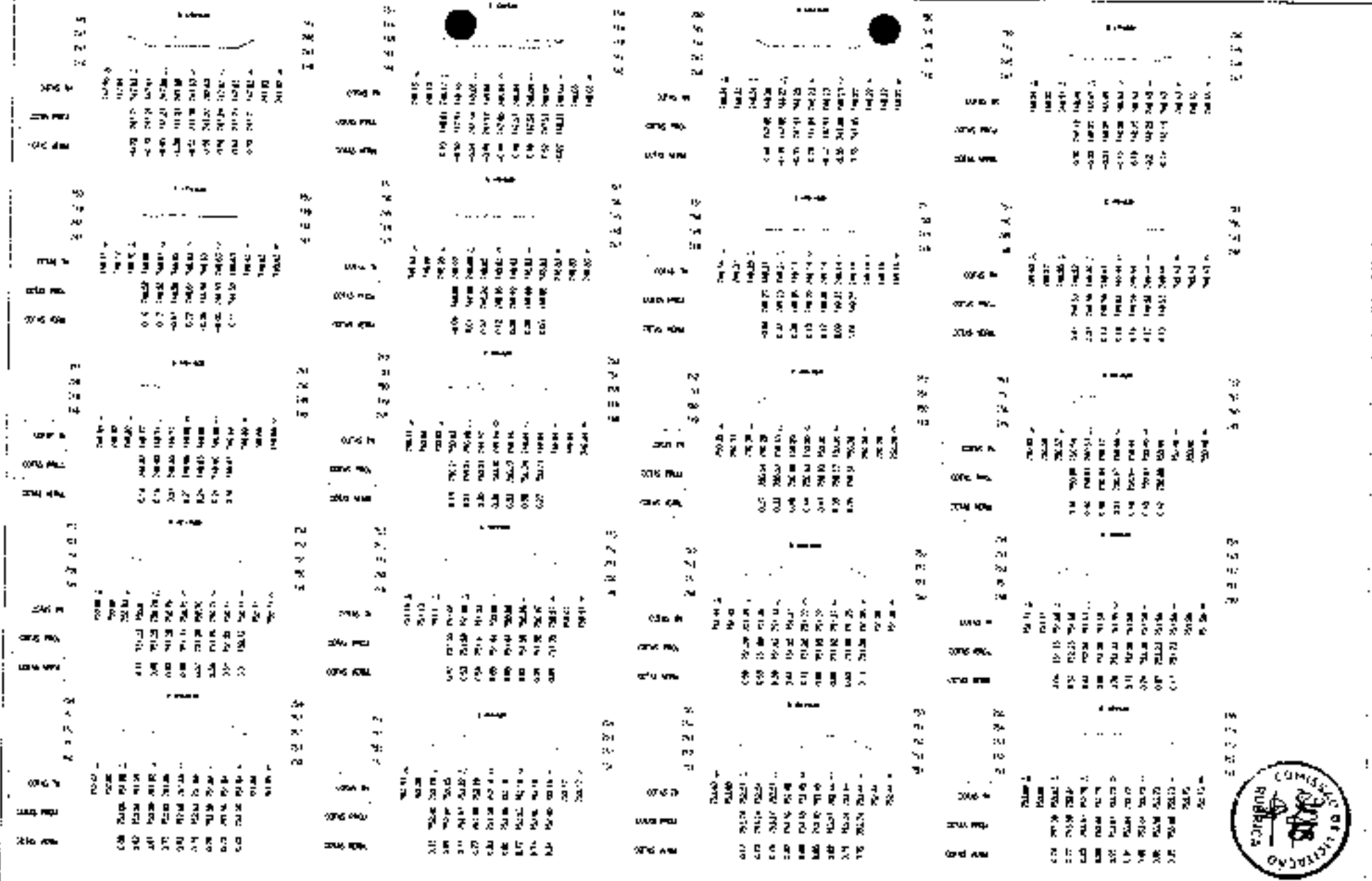

-  ATERRADO
-  CORTES



PREFEITURA MUNICIPAL DE GUARACIABA DO NORTE RECONSTRUÇÃO DE ESTRADAS VICINAIS NO MUNICÍPIO DE GUARACIABA CO-MUNICÍPIO - PT 10867043 SEÇÕES TRANSVERSAIS		Escala: 1:500 50 / 75 1:500
PROPOSTA	VILA CEL. FERREIRA FERREIRA, SÍTIO, LOTEAMENTO, RECONSTRUÇÃO DE ESTRADAS VICINAIS E RECONSTRUÇÃO DE ESTRADAS VICINAIS E RECONSTRUÇÃO DE ESTRADAS VICINAIS	
PROJETO	RECONSTRUÇÃO DE ESTRADAS VICINAIS E RECONSTRUÇÃO DE ESTRADAS VICINAIS E RECONSTRUÇÃO DE ESTRADAS VICINAIS	



LEGENDA

-  ALIARRO
-  COMTE

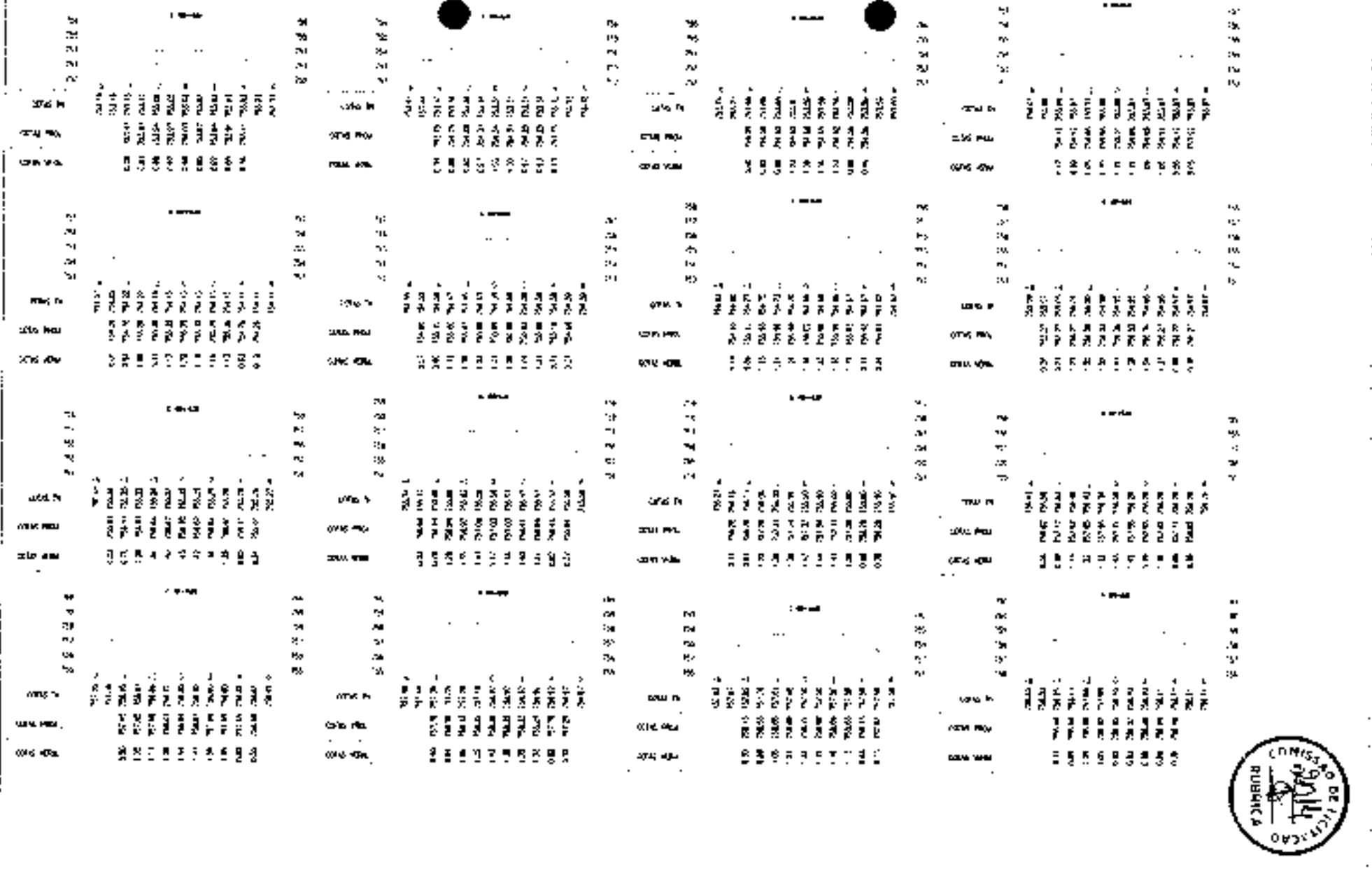

PREFEITURA MUNICIPAL DE GUARACIABA DO NORTE		DATA
RECUPERAÇÃO DE ESTRADAS VIZINÂNCIA MUNICIPAL DE GUARACIABA		51/73
CC Nº 011-CE - FT 10627000		
SEÇÕES TRANSVERSAIS		
PROJETO	ENG. CIVIL ANDRÉ CARLOS TORRES DE MENEZES	
APROVA	PLANO ANEXO DE TENDAS E DE REGISTRAÇÃO DE OBRAS	



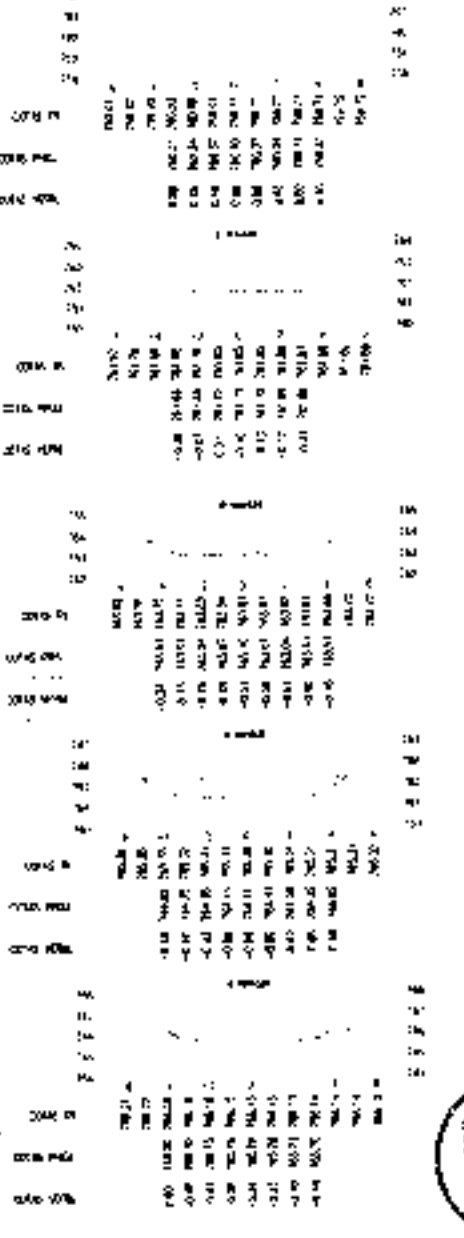
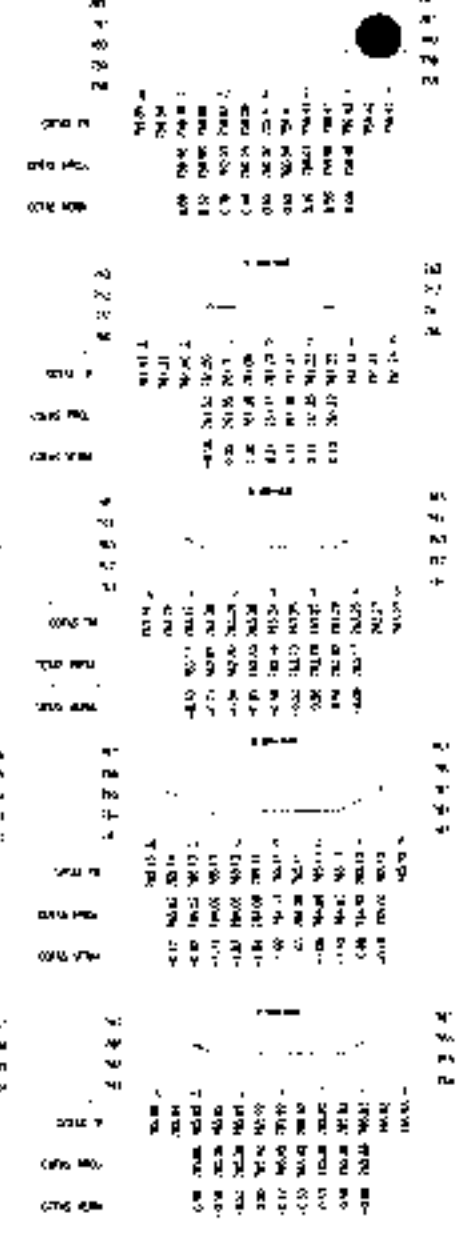
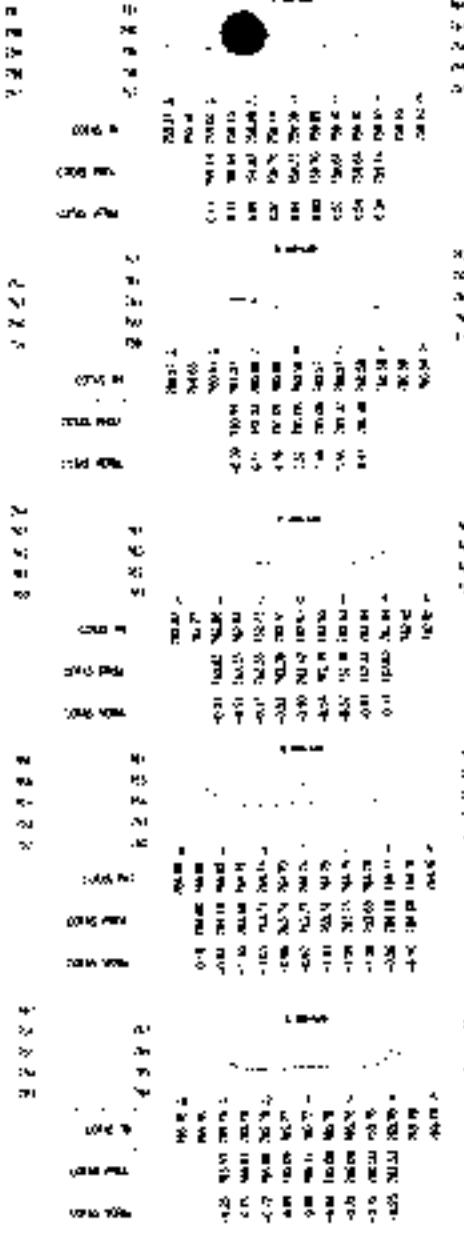
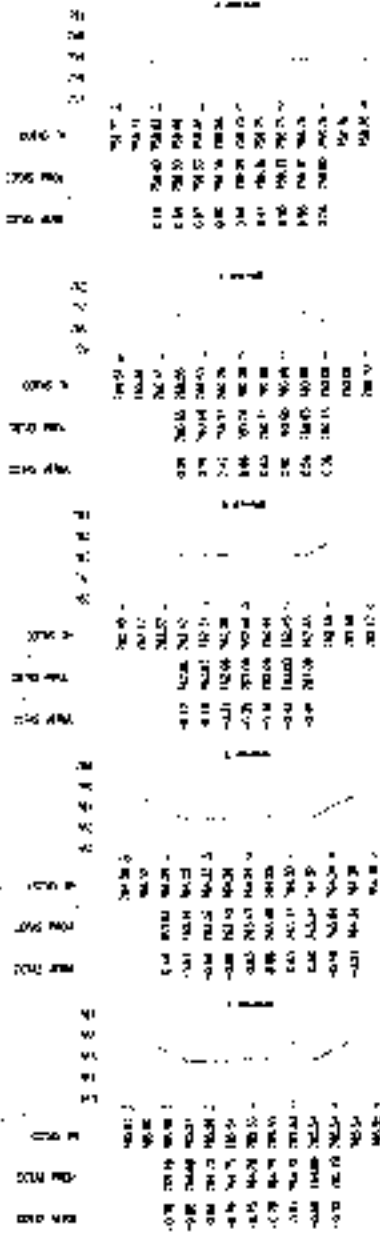

LEGENDA

ATERRO

COATE



PREFEITURA MUNICIPAL DE GUARACIABA DO NORTE

RECUPERAÇÃO DE ESTRADAS VICINAIS NO MUNICÍPIO DE GUARACIABA DO NORTE-CE - PT. 1085276-00

SEÇÕES TRANSVERSAIS

PROJETO DE ARQUITETURA E LAYOUT

PROJ. FONDAÇÃO, OBRAS DE INFRAESTRUTURA E SERVIÇOS

52/72

Item	Descrição	Valor	Item	Descrição	Valor	Item	Descrição	Valor	Item	Descrição	Valor
1	1	1	1





SECRETARIA MUNICIPAL DE GUARABÁ DO NORTE
REG. EM RUA DE ESTADUAIS MUNICÍPIOS AO MANTENIMENTO DE GUARABÁ DO NORTE - CE - PT 1086270-01
SEÇÕES TRANSMISSÃO

Nº 1234
 Nº 1234



LEGENDA
 ATENÇÃO
 CUIDADO

LEGENDA

-  ATERRO
-  CORTE

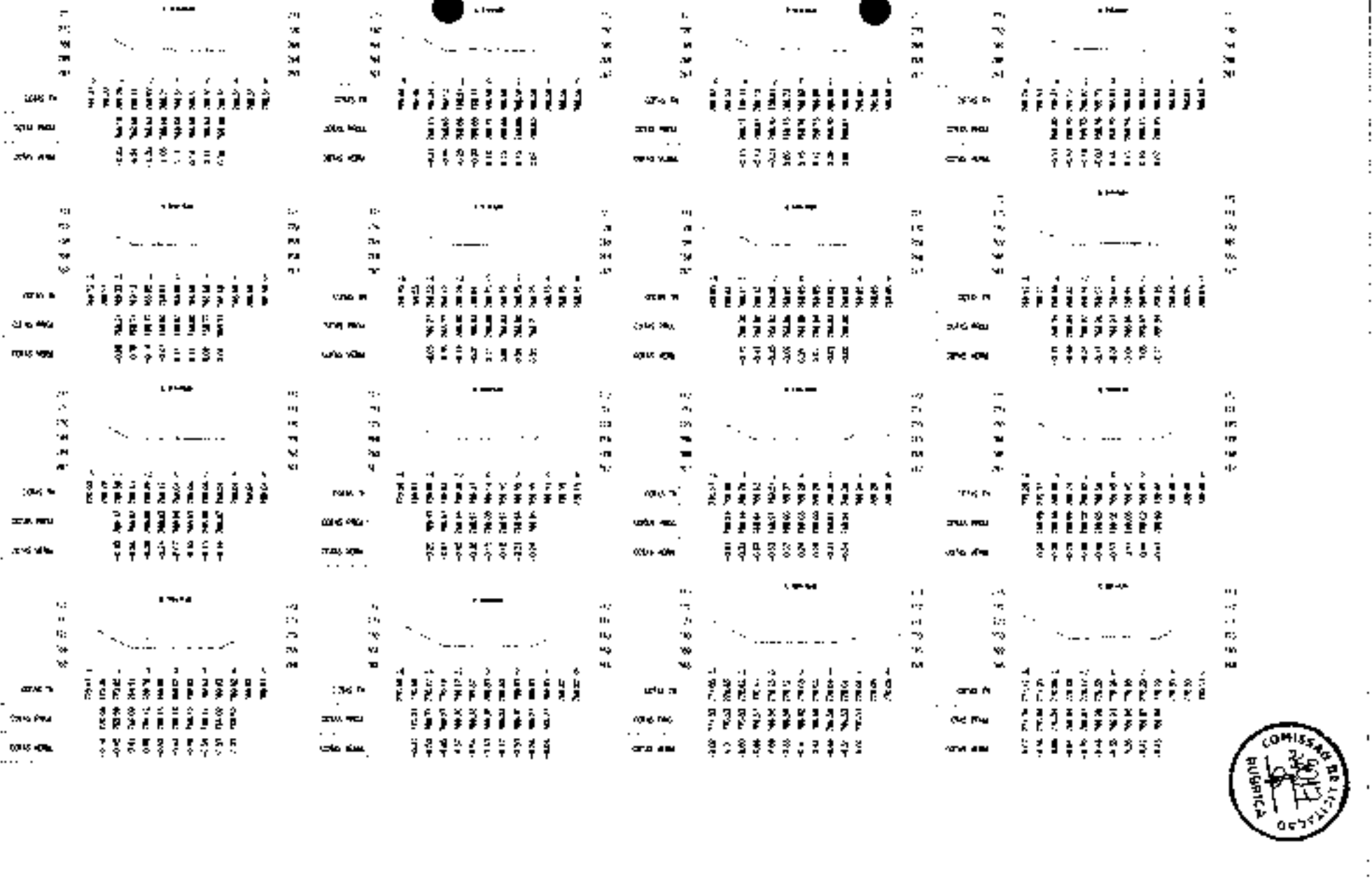

PREFEITURA MUNICIPAL DE GUARACIABA DO NORTE	
REDEFINIÇÃO DE ESTRADAS MUNICIPAIS NO MUNICÍPIO DE GUARACIABA DO NORTE - CE - PT 1286273-03	
SEÇÕES TRANSVERSAIS	
PROJETA	DR. JOAQUIM NEVES TORRES NETO - MEC
REVISÃO	FRANCISCA ANDRÉIA FERREIRA - ENGENHEIRA CIVIL

54 / 73

1/2000



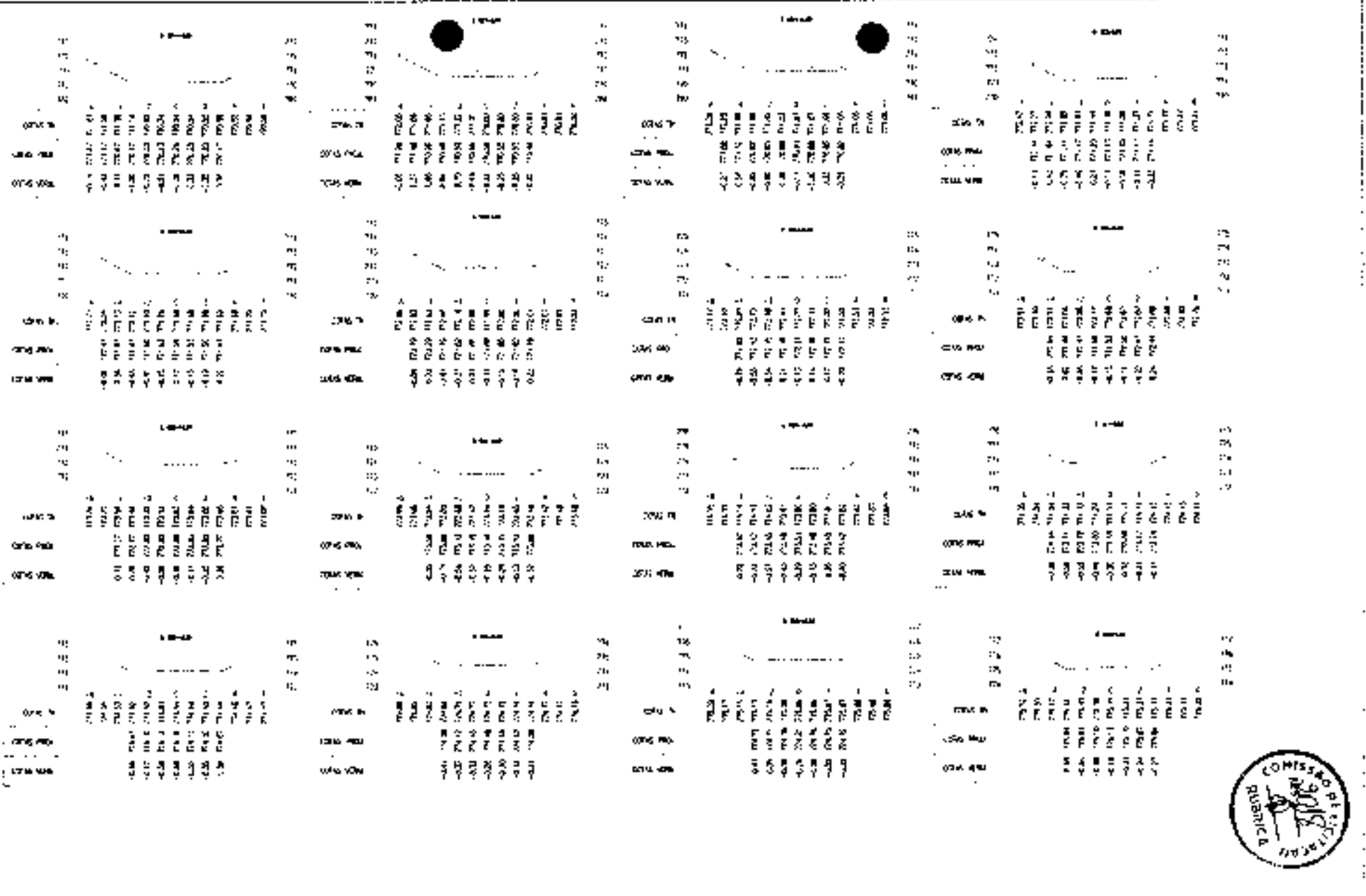

LEGENDA

 ATERRC

 CORTES

	PREFEITURA MUNICIPAL DE GUARACIABA DO NORTE RECUPERAÇÃO DE ESTRADAS URBANAS NO MUNICÍPIO DE GUARACIABA DO NORTE - CE - PT 1068273-03 SEÇÕES TRANSEVERSAIS		55 / 73
	Município: GUARACIABA DO NORTE - CE Avenida: AV. BRASÃO DE ARMAS - 1068273-03	Escala: 1:1000 Data: 20/08/2023	

Item	Descrição	Valor	Valor	Valor	Valor	Valor	Valor	Valor	Valor
1
2
3
4
5
6
7
8
9
10
11
12
13
14
15
16
17
18
19
20
21
22
23
24
25
26
27
28
29
30
31
32
33
34
35
36
37
38
39
40
41
42
43
44
45
46
47
48
49
50
51
52
53
54
55
56
57
58
59
60
61
62
63
64
65
66
67
68
69
70
71
72
73
74
75
76
77
78
79
80
81
82
83
84
85
86
87
88
89
90
91
92
93
94
95
96
97
98
99
100



PREFEITURA MUNICIPAL DE GUARACIAMA DO NORTE
RECUPERAÇÃO DE ESTRADAS VICINAIS NO MUNICÍPIO DE GUARACIAMA
LC Nº 04/2019 - PT 1009/2003
SEÇÃO TRANSPORTES

56 / 73
 2019

ATA
ATA Nº 001/2019 - 1ª Sessão Ordinária
15 de Maio de 2019

LEGE VOA

ATELADO

CORTE

Item	Descrição	Quantidade	Valor Unitário	Valor Total
1
2
3
4
5
6
7
8
9
10
11
12
13
14
15
16
17
18
19
20
21
22
23
24
25
26
27
28
29
30
31
32
33
34
35
36
37
38
39
40
41
42
43
44
45
46
47
48
49
50
51
52
53
54
55
56
57
58
59
60
61
62
63
64
65
66
67
68
69
70
71
72
73
74
75
76
77
78
79
80
81
82
83
84
85
86
87
88
89
90
91
92
93
94
95
96
97
98
99
100

ATERRO

CORTE

LEGENDA



PREFEITURA MUNICIPAL DE QUARANÁIA DE NORTE
RECUPERAÇÃO DE ESTRADAS VICIAIS DO MUNICÍPIO DE QUARANÁIA DE NORTE - CE - PT LIBERTADOR
SEÇÕES TRANSVERSAIS

Projeto executivo elaborado por: ...
 Escala: ...

57 / 73



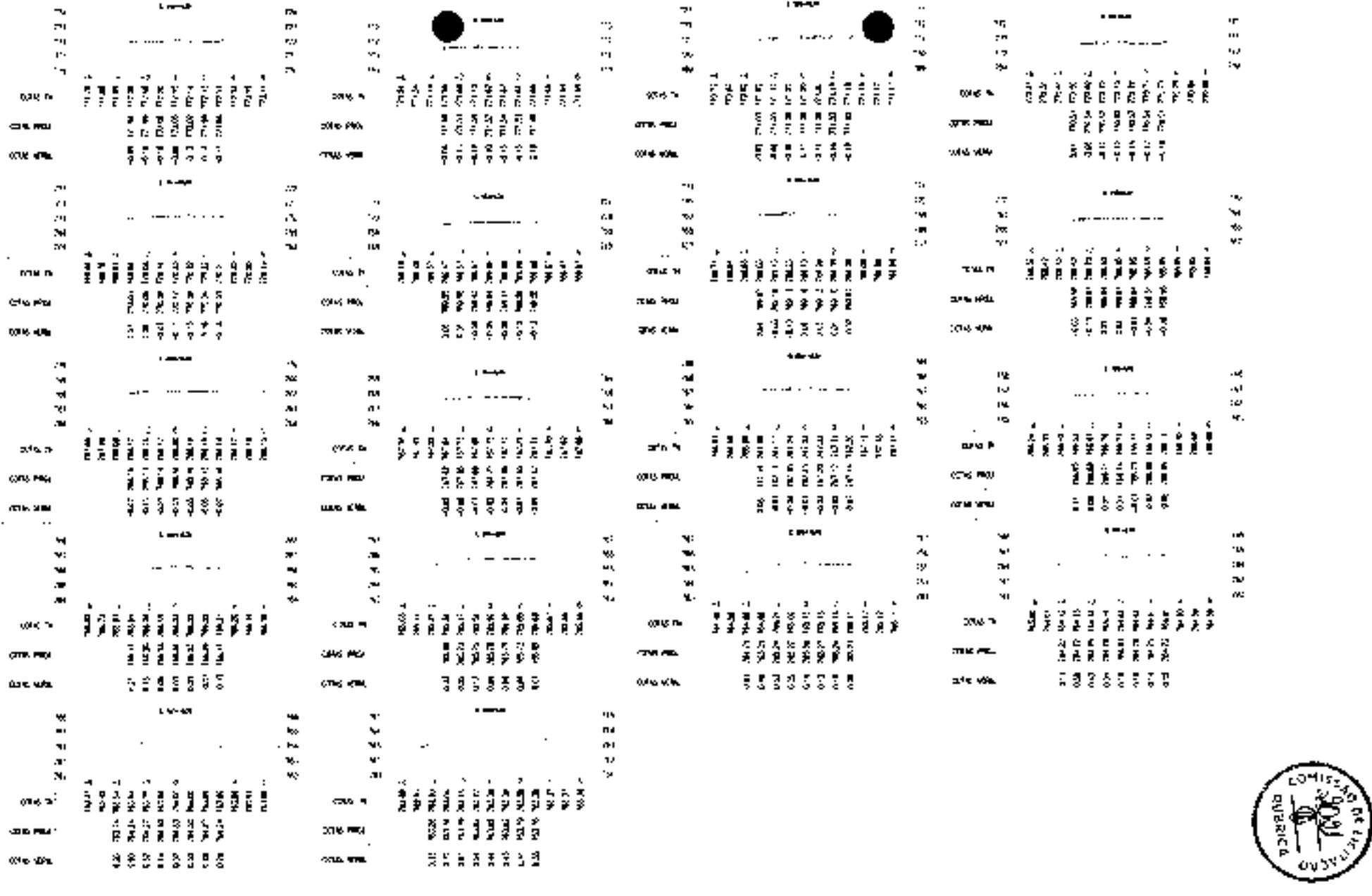

LEGENDA



ATERRO

CORTE

	PREFEITURA MUNICIPAL DE GUARACIABA DO NORTE RECUPERAÇÃO DE ESTRADAS VICINAIS NO MUNICÍPIO DE GUARACIABA DO NORTE-CE - P. 1006270-00		58 / 73 1:250
	PROPOSTA	PROJETO DE RECUPERAÇÃO DE ESTRADAS VICINAIS	



LEGENDA

-  ATERRO
-  CURTE

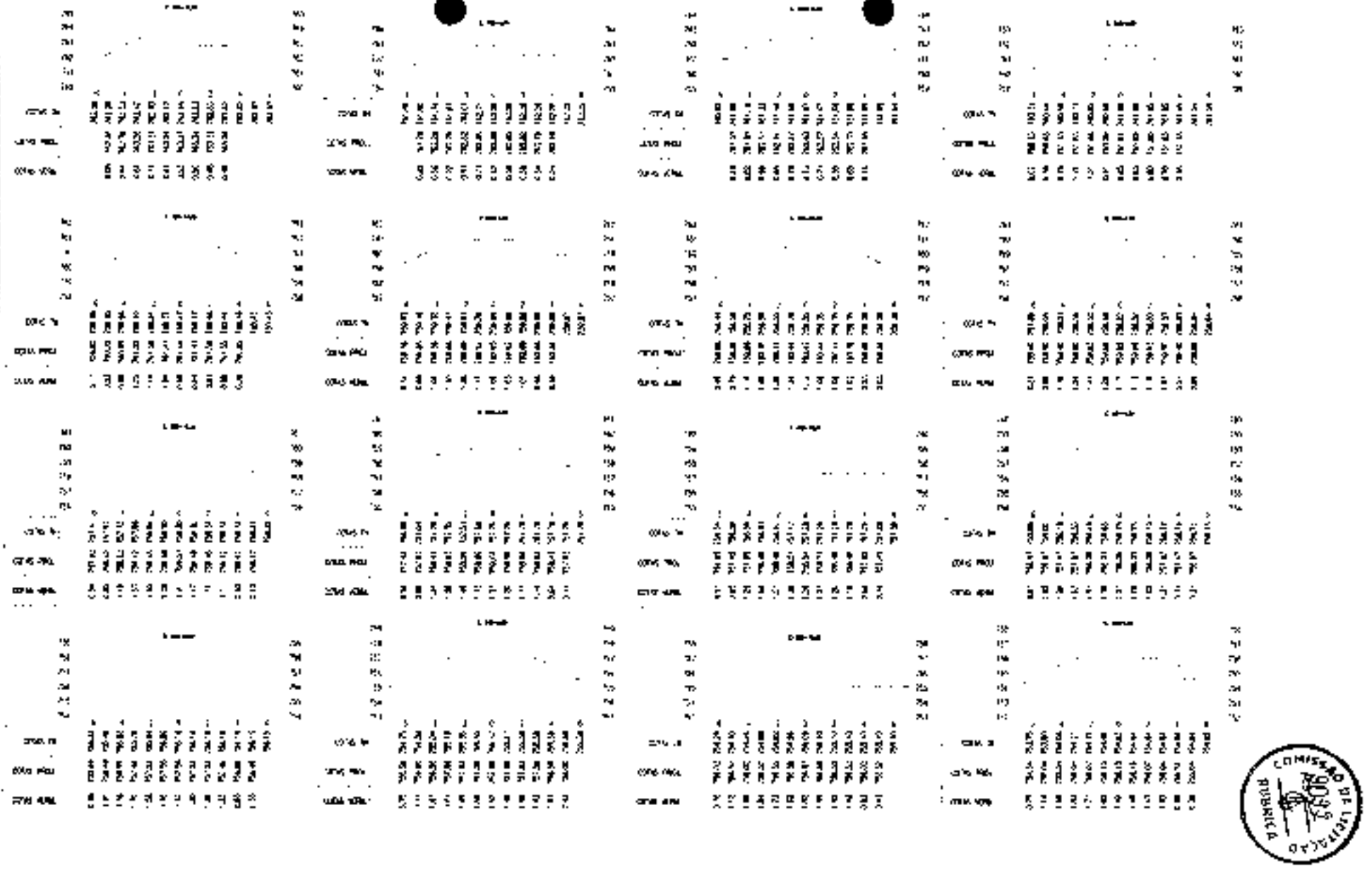



JOTA BARRIS
PROJETOS

MUNICÍPIO DE QUARACIARA DO NORTE

RECUPERAÇÃO DE ESTRADAS VICINAIS NO MUNICÍPIO DE QUARACIARA DO NORTE-CE - PT 106627/0-03

SEÇÕES TRANSVERSAIS

PROJETO: 106627/0-03

ARQUIVO: 106627/0-03

PROJETO: 106627/0-03

ARQUIVO: 106627/0-03

PROJETO: 106627/0-03

ARQUIVO: 106627/0-03

PROJETO: 106627/0-03

ARQUIVO: 106627/0-03



LEGENDA

- ATERRÇO
- CORTE

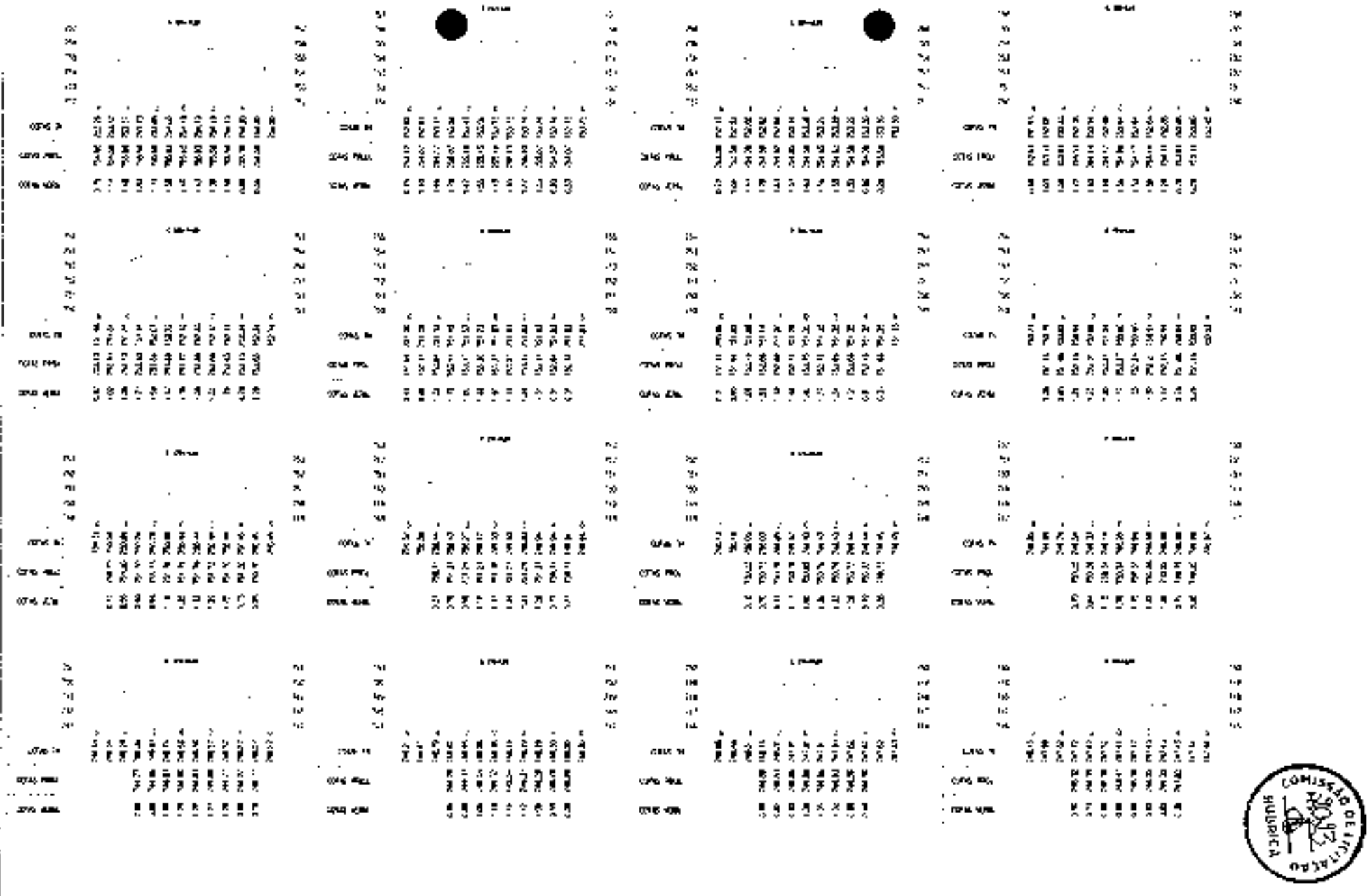

	HEMIFÉLTRA MUNICIPAL DE GUARACIABA DO NORTE RECLPERAÇÃO DE ESTRADAS VICINAIS NO MUNICÍPIO DE GUARACIABA DO NORTE-CE - PT 1188707C-01 SEÇÕES TRANSVERSAIS		Número 60 / 71
	PROJETO:	DE:	DATA:





 JOTA BARROS ARQUITETOS	PREFEITURA MUNICIPAL DE GLARACIARA DO NORTE		4274
	RECUPERAÇÃO DE ESTADAS VICINAIS NO MUNICÍPIO DE GLARACIARA DO NORTE-CE - PT: 086770-C3		61/73
	SEÇÕES TRANSVERSAIS		04/24
PROJETA	DR. JOÃO CARLOS FERREIRA DE ALMEIDA JUNIOR		11/2024
APROVA	PREFEITO JOÃO CARLOS FERREIRA DE ALMEIDA JUNIOR		

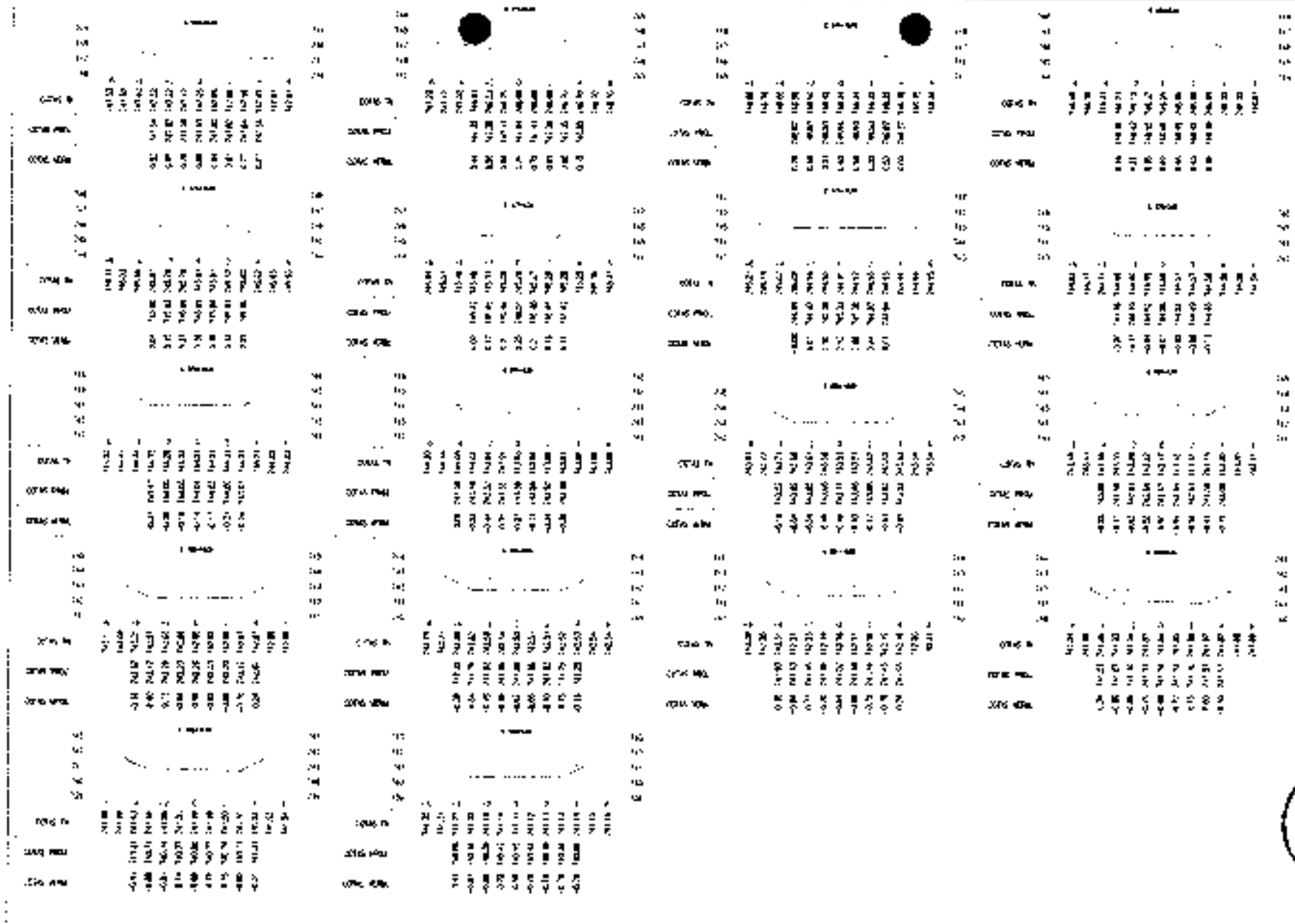

LEGENDA

	ATERRAMENTO
	CORTES



PREFEITURA MUNICIPAL DE GUARACABA DO NORTE
 RECUPERAÇÃO DE ESTRADAS VICINAIS NO MUNICÍPIO DE GUARACABA DO NORTE-CE - PT 138x270-03
 SEÇÃO 6 TRANSEMBAS

EMPRESA:	DETA SOLUÇÕES AMBIENTAIS LTDA - ME
PROJETO:	PROJETO DE RECUPERAÇÃO DE ESTRADAS

DATA: 14/07/2014
 Nº: 62 / 73
 1/256

LEGENDA

	ATERRO
	CORTE

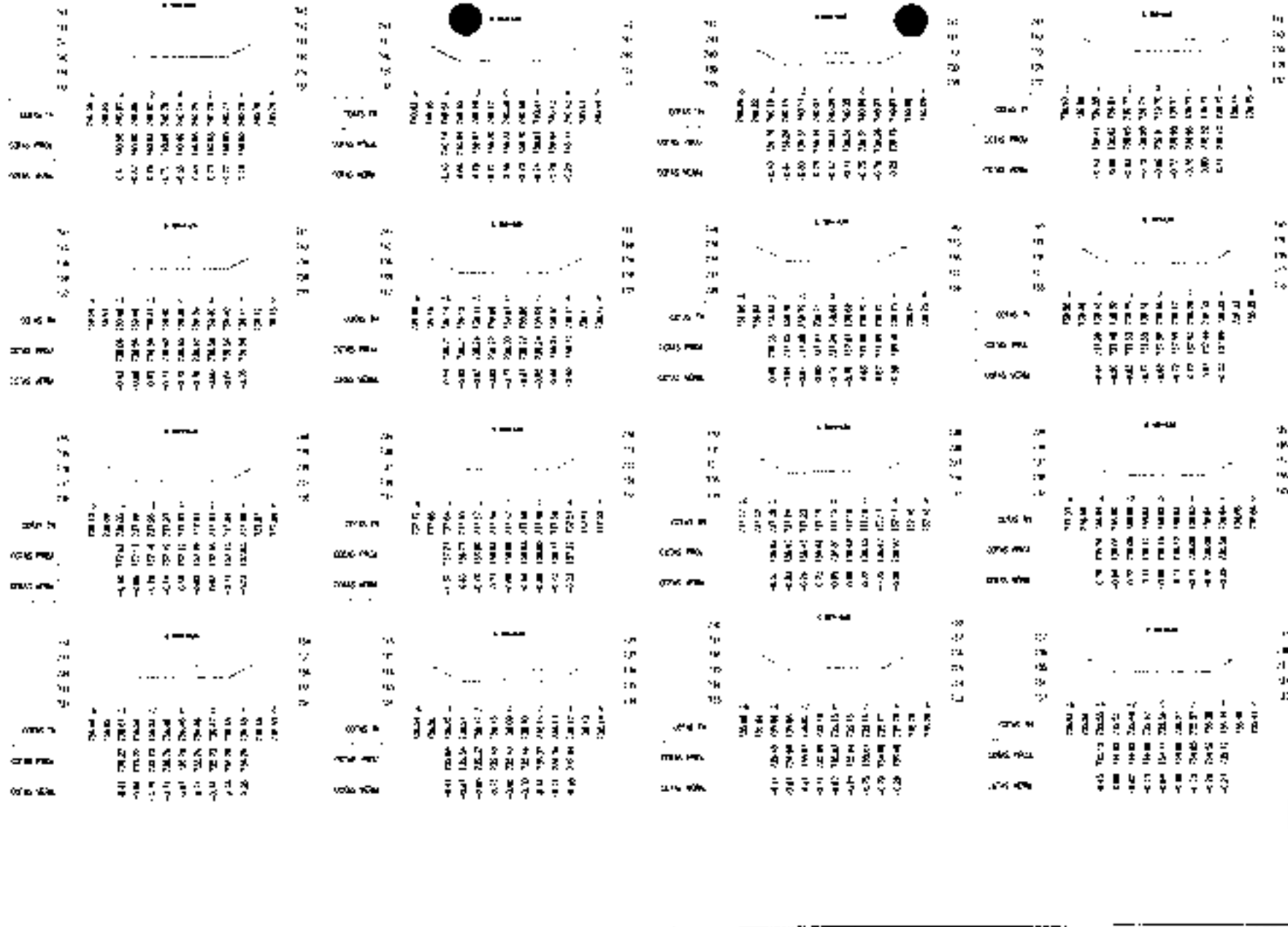



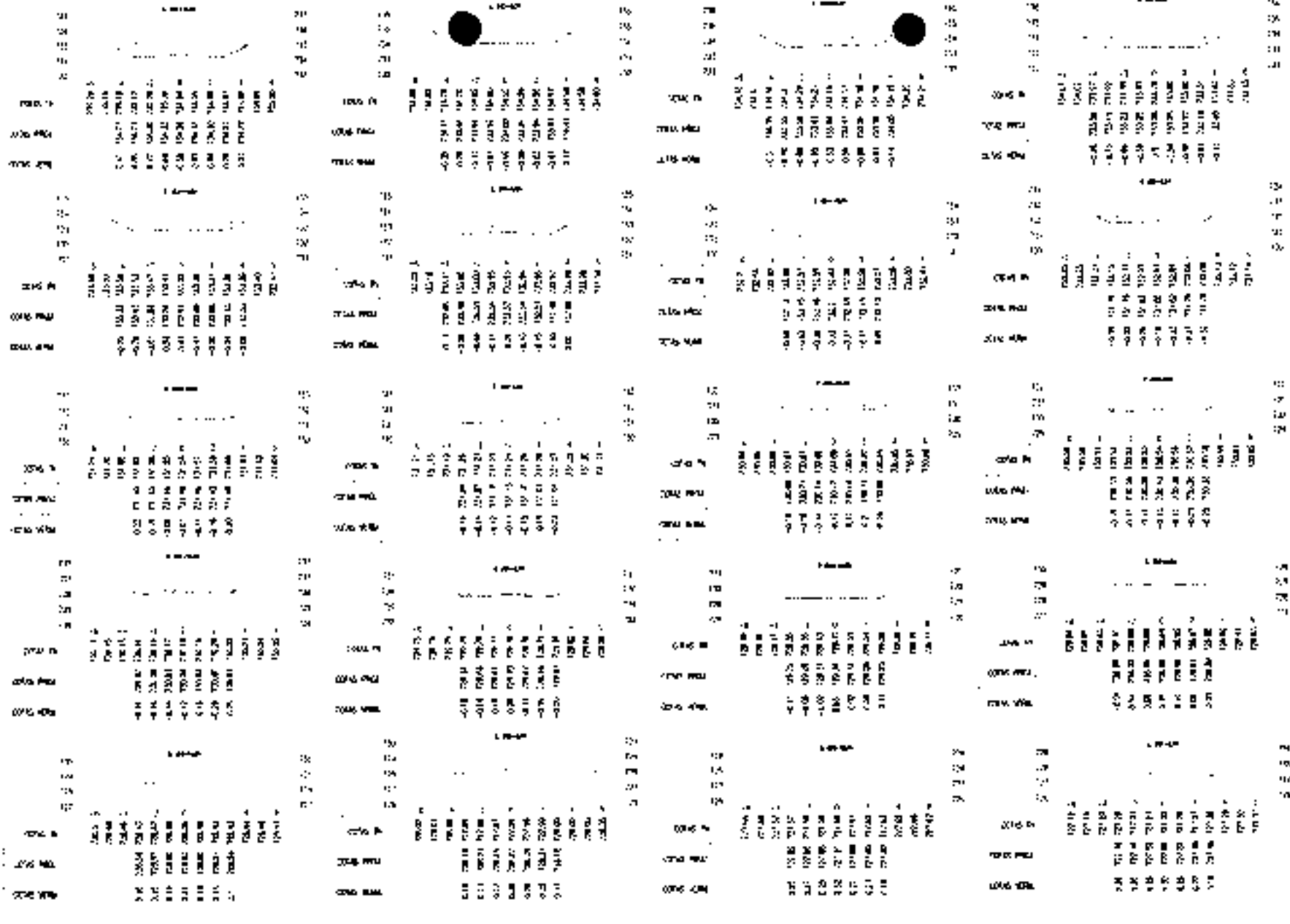

PREFEITURA MUNICIPAL DE GUARACIABA DO NORTE		1416
RECUPERAÇÃO DE ESTRADAS VICINAIS NO MUNICÍPIO DE GUARACIABA DO NORTE-CE - AT. 0667003		63 / 73
SEÇÕES TRANSVERSAIS		1:250
PROJETA	DR. CARLOS ALBERTO MACHADO, ENGENHEIRO CIVIL	
APROVA	PREF. CARLOS ALBERTO MACHADO, PREFEITO MUNICIPAL	



LEGENDA

-  ATERRO
-  CORTE

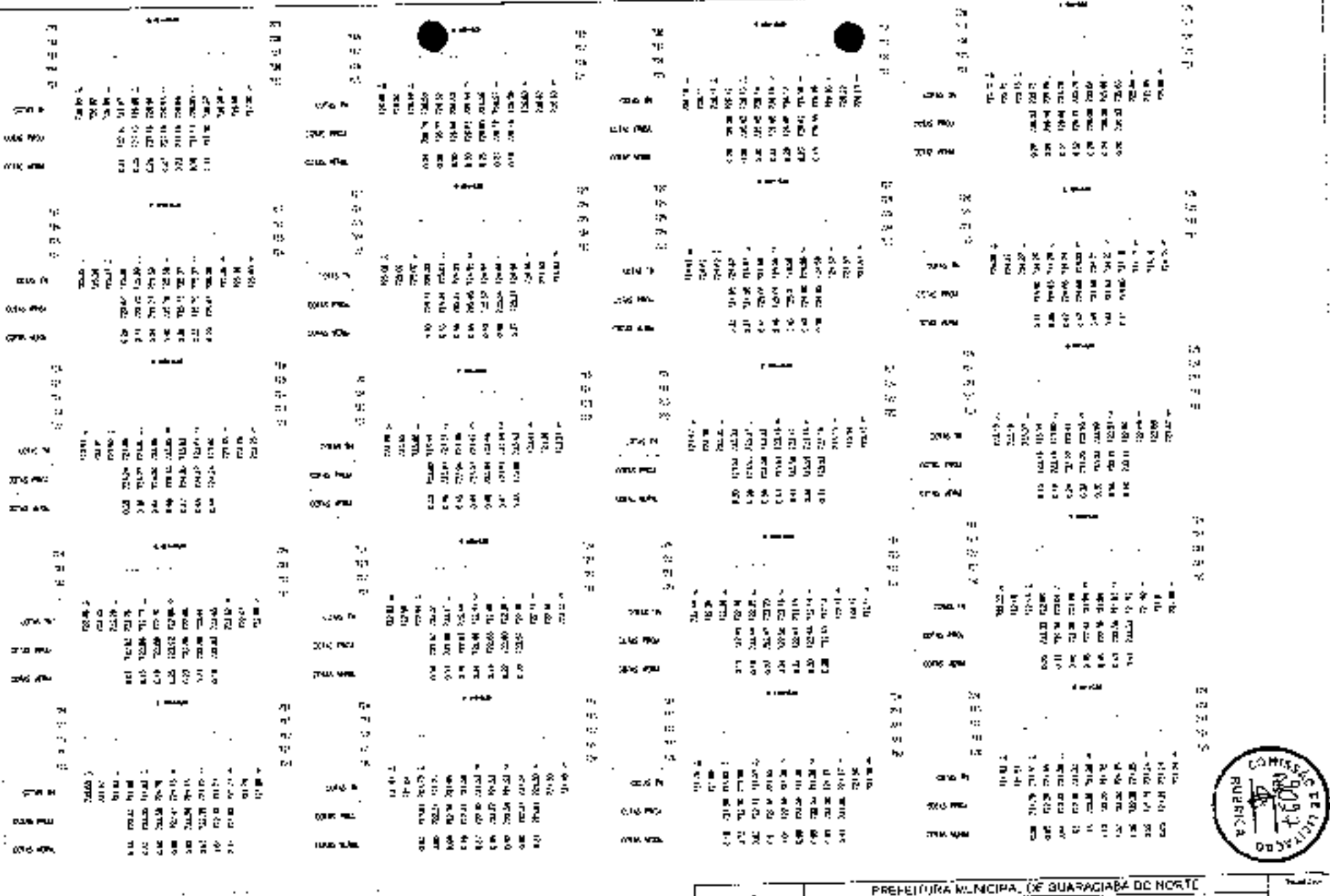

PREFEITURA MUNICIPAL DE GUARACIABA DO NORTE
 RECUPERAÇÃO DE ESTRADAS VICINAIS NO MUNICÍPIO DE GUARACIABA DO NORTE-CE - PT 106627000
 SEÇÕES TRANSVERSAIS

64 / 72
 1986





PREFEITURA MUNICIPAL DE GUARACIABA DO NORTE
RECONSTRUÇÃO DE ESTRADAS VICINAIS NO MUNICÍPIO DE GUARACIABA DO NORTE-CE - FT 1066270-01
SEÇÕES TRANSVERSAIS
 Nº 01/2014
 Rua: ...
 ...

65 / 73
 2014

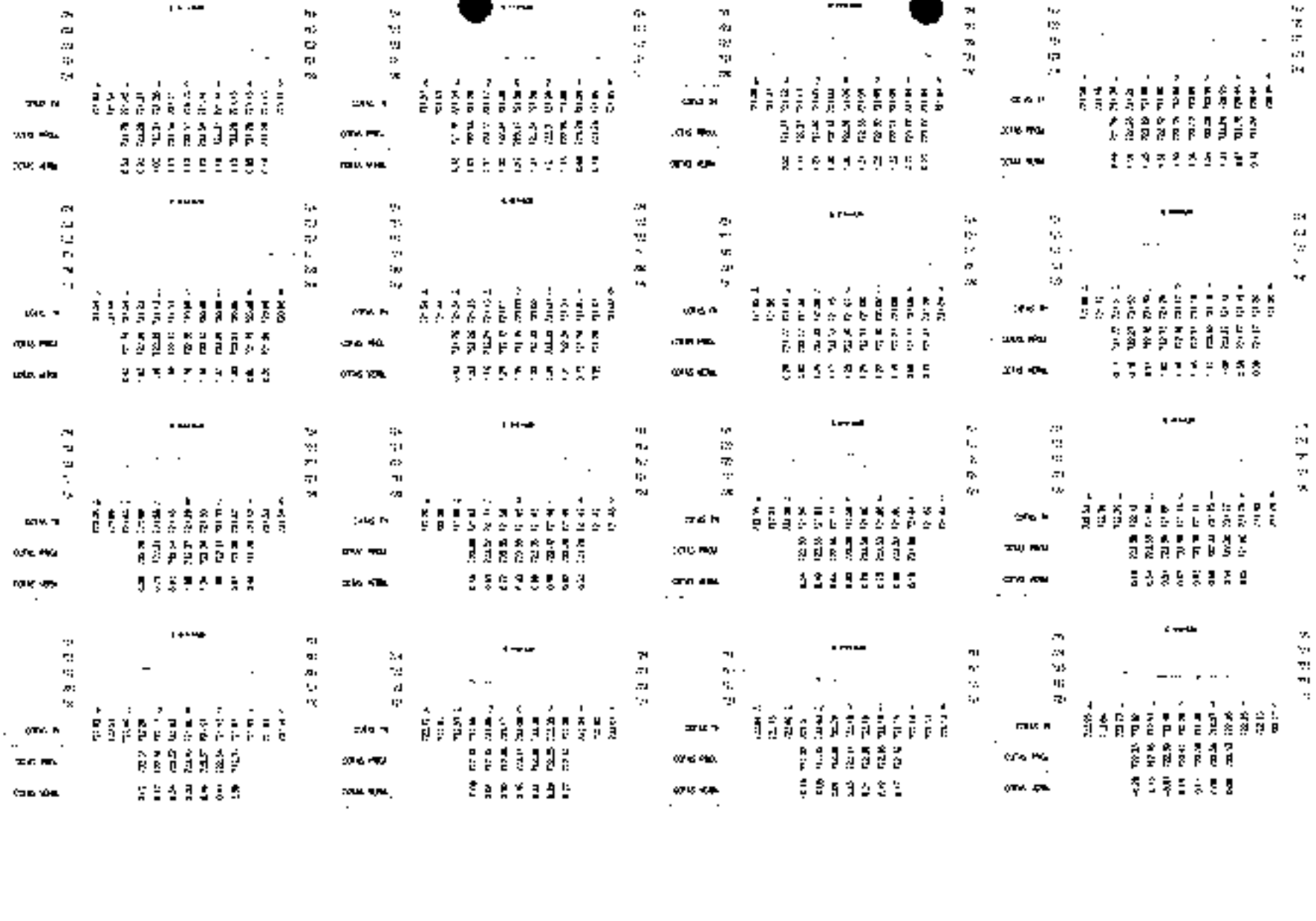

LEGENDA
 [] ATERRO
 [] CORTE

LEGENDA

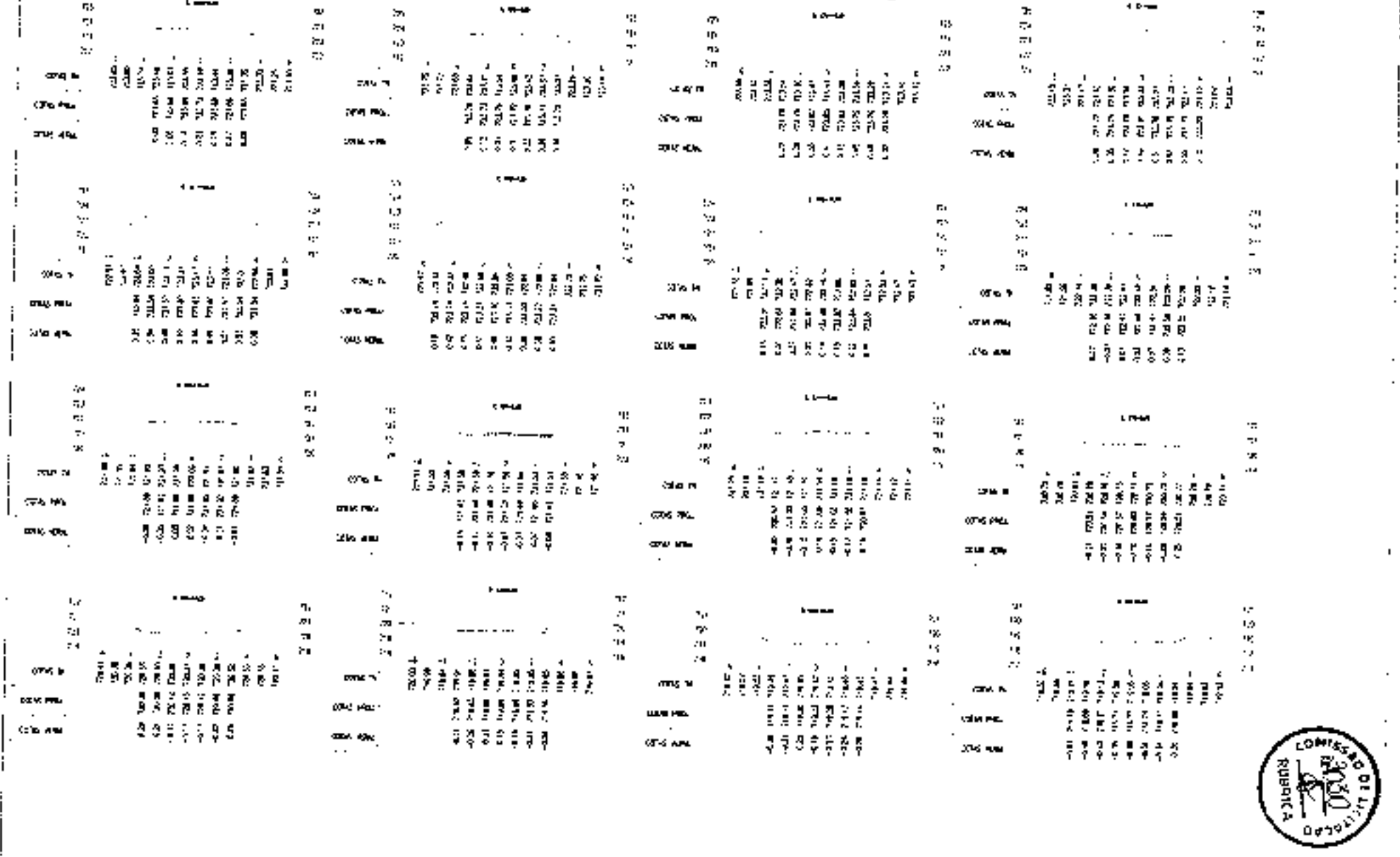
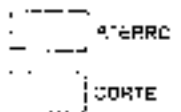

PREFEITURA MUNICIPAL DE CLARACABA DO NORTE RECUPERAÇÃO DE ESTRADAS VICINAIS NO MUNICÍPIO DE CLARACABA DO NORTE - CE - FT: 086270-01		67/72
SEÇÕES TRANSVERSAIS		
PROJETISTA JOA BARROS PROJETOS	ENDEREÇO RUA JOA BARROS, 100 - JARDIM ARAUCÁRIA - CLARACABA DO NORTE - CE	DATA 10/05/2024



Item	Descrição	Valor	Item	Descrição	Valor	Item	Descrição	Valor	Item	Descrição	Valor
01	01	01	01



PREFETURA MUNICIPAL DE GUARACIABA DO NORTE
RECUPERAÇÃO DE ESTRADAS VICINAIS NO MUNICÍPIO DE GUARACIABA
CONTRATO - CL - Nº 10687/001
SEÇÃO DE TRANSPORTES

89 / 73

ATA DE ABERTURA DE ENVELOPES

Nº 001/2000

LEGENDA

ATERRO

GRATE

REVENDA

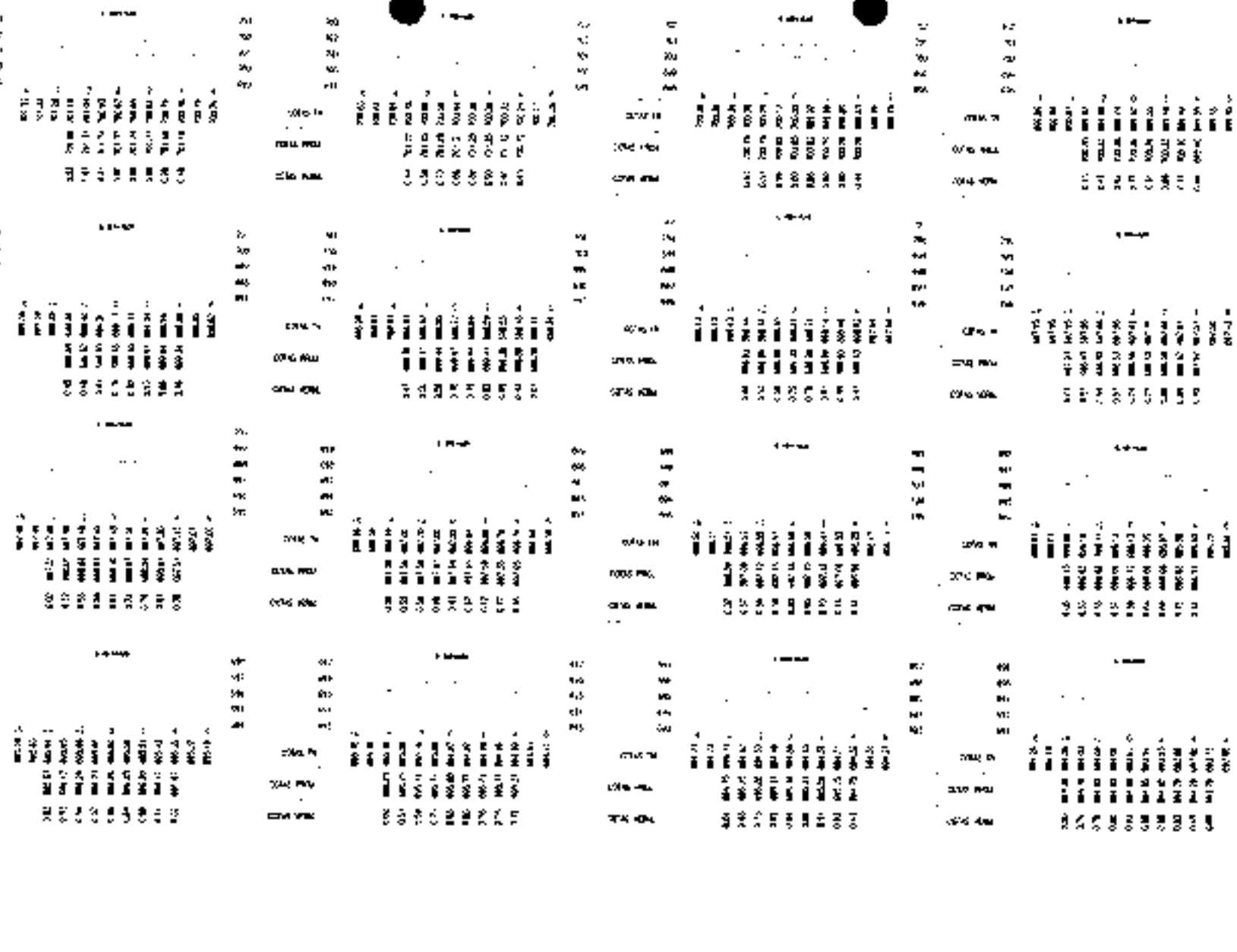
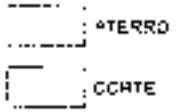

PRÉFECTURA MUNICIPAL DE GUARACIABA DO NORTE
 RECUPERAÇÃO DE ESTRADAS VICINAIS NO MUNICÍPIO DE GUARACIABA DO NORTE-CE-PT 1986/2000
 SEÇÕES TRANSVERSAIS

PROJETO: CRIAÇÃO DE 1000 METROS DE CALÇADÃO
 LOCAL: TRAV. 1000M DE CALÇADÃO - BARRIO DO LINDO



70 / 74

1/200



71 / 73

PREFEITURA MUNICIPAL DE GUARACIABA DO NORTE
 LOCALIZAÇÃO DE ESTRADAS VICINIAS AO MUNICÍPIO DE GUARACIABA
 DO NORTE-CE - PT 11952710-02
 SEÇÕES TRANSVERSAIS



1 - 100m

001	002	003	004	005	006	007	008	009	010
011	012	013	014	015	016	017	018	019	020
021	022	023	024	025	026	027	028	029	030
031	032	033	034	035	036	037	038	039	040
041	042	043	044	045	046	047	048	049	050
051	052	053	054	055	056	057	058	059	060
061	062	063	064	065	066	067	068	069	070
071	072	073	074	075	076	077	078	079	080
081	082	083	084	085	086	087	088	089	090
091	092	093	094	095	096	097	098	099	100

1 - 200m

101	102	103	104	105	106	107	108	109	110
111	112	113	114	115	116	117	118	119	120
121	122	123	124	125	126	127	128	129	130
131	132	133	134	135	136	137	138	139	140
141	142	143	144	145	146	147	148	149	150
151	152	153	154	155	156	157	158	159	160
161	162	163	164	165	166	167	168	169	170
171	172	173	174	175	176	177	178	179	180
181	182	183	184	185	186	187	188	189	190
191	192	193	194	195	196	197	198	199	200

2 - 100m

201	202	203	204	205	206	207	208	209	210
211	212	213	214	215	216	217	218	219	220
221	222	223	224	225	226	227	228	229	230
231	232	233	234	235	236	237	238	239	240
241	242	243	244	245	246	247	248	249	250
251	252	253	254	255	256	257	258	259	260
261	262	263	264	265	266	267	268	269	270
271	272	273	274	275	276	277	278	279	280
281	282	283	284	285	286	287	288	289	290
291	292	293	294	295	296	297	298	299	300

2 - 200m

301	302	303	304	305	306	307	308	309	310
311	312	313	314	315	316	317	318	319	320
321	322	323	324	325	326	327	328	329	330
331	332	333	334	335	336	337	338	339	340
341	342	343	344	345	346	347	348	349	350
351	352	353	354	355	356	357	358	359	360
361	362	363	364	365	366	367	368	369	370
371	372	373	374	375	376	377	378	379	380
381	382	383	384	385	386	387	388	389	390
391	392	393	394	395	396	397	398	399	400

3 - 100m

401	402	403	404	405	406	407	408	409	410
411	412	413	414	415	416	417	418	419	420
421	422	423	424	425	426	427	428	429	430
431	432	433	434	435	436	437	438	439	440
441	442	443	444	445	446	447	448	449	450
451	452	453	454	455	456	457	458	459	460
461	462	463	464	465	466	467	468	469	470
471	472	473	474	475	476	477	478	479	480
481	482	483	484	485	486	487	488	489	490
491	492	493	494	495	496	497	498	499	500

3 - 200m

501	502	503	504	505	506	507	508	509	510
511	512	513	514	515	516	517	518	519	520
521	522	523	524	525	526	527	528	529	530
531	532	533	534	535	536	537	538	539	540
541	542	543	544	545	546	547	548	549	550
551	552	553	554	555	556	557	558	559	560
561	562	563	564	565	566	567	568	569	570
571	572	573	574	575	576	577	578	579	580
581	582	583	584	585	586	587	588	589	590
591	592	593	594	595	596	597	598	599	600

4 - 100m

601	602	603	604	605	606	607	608	609	610
611	612	613	614	615	616	617	618	619	620
621	622	623	624	625	626	627	628	629	630
631	632	633	634	635	636	637	638	639	640
641	642	643	644	645	646	647	648	649	650
651	652	653	654	655	656	657	658	659	660
661	662	663	664	665	666	667	668	669	670
671	672	673	674	675	676	677	678	679	680
681	682	683	684	685	686	687	688	689	690
691	692	693	694	695	696	697	698	699	700

4 - 200m

701	702	703	704	705	706	707	708	709	710
711	712	713	714	715	716	717	718	719	720
721	722	723	724	725	726	727	728	729	730
731	732	733	734	735	736	737	738	739	740
741	742	743	744	745	746	747	748	749	750
751	752	753	754	755	756	757	758	759	760
761	762	763	764	765	766	767	768	769	770
771	772	773	774	775	776	777	778	779	780
781	782	783	784	785	786	787	788	789	790
791	792	793	794	795	796	797	798	799	800

LEGENDA

□ ATERRO

□ CORTA



PREFEITURA MUNICIPAL DE GUARACIABA DO NORTE RECUPERAÇÃO DE ESTRADAS VICINAIS NO MUNICÍPIO DE GUARACIABA DO NORTE-CE - PT 1036274-10		Nº 72173
BÊCOES TRANSVERSAIS		1/200
PROPOSTA Nº:	DATA DE ENTREGA:	LOCAL:
Nº:	ÀS:	EM:

ALÍNEA	DESCRIÇÃO	QUANTIDADE	VALOR UNITÁRIO	VALOR TOTAL
001	ATERRO	1000	1000000	1000000
002	CCRTE	1000	1000000	1000000
003
004
005
006
007
008
009
010
011
012
013
014
015
016
017
018
019
020
021
022
023
024
025
026
027
028
029
030
031
032
033
034
035
036
037
038
039
040
041
042
043
044
045
046
047
048
049
050

LEGENDA

ATERRO

CCRTE



 JOÃO SARRÃO ENGENHARIA	PREFEITURA MUNICIPAL DE GUARACIABA DO NORTE		73173
	RECUPERAÇÃO DE ESTIPACAS VILANIS NO MUNICÍPIO DE GUARACIABA DO NORTE - CE - PI 10862/0-03		
	SEÇÕES TRANSVERSAIS		
Projeto de	Projeto de urbanização de loteamentos - Recuperação		
Escala	1:250		

LEGENDA

ATERRO

CORTE

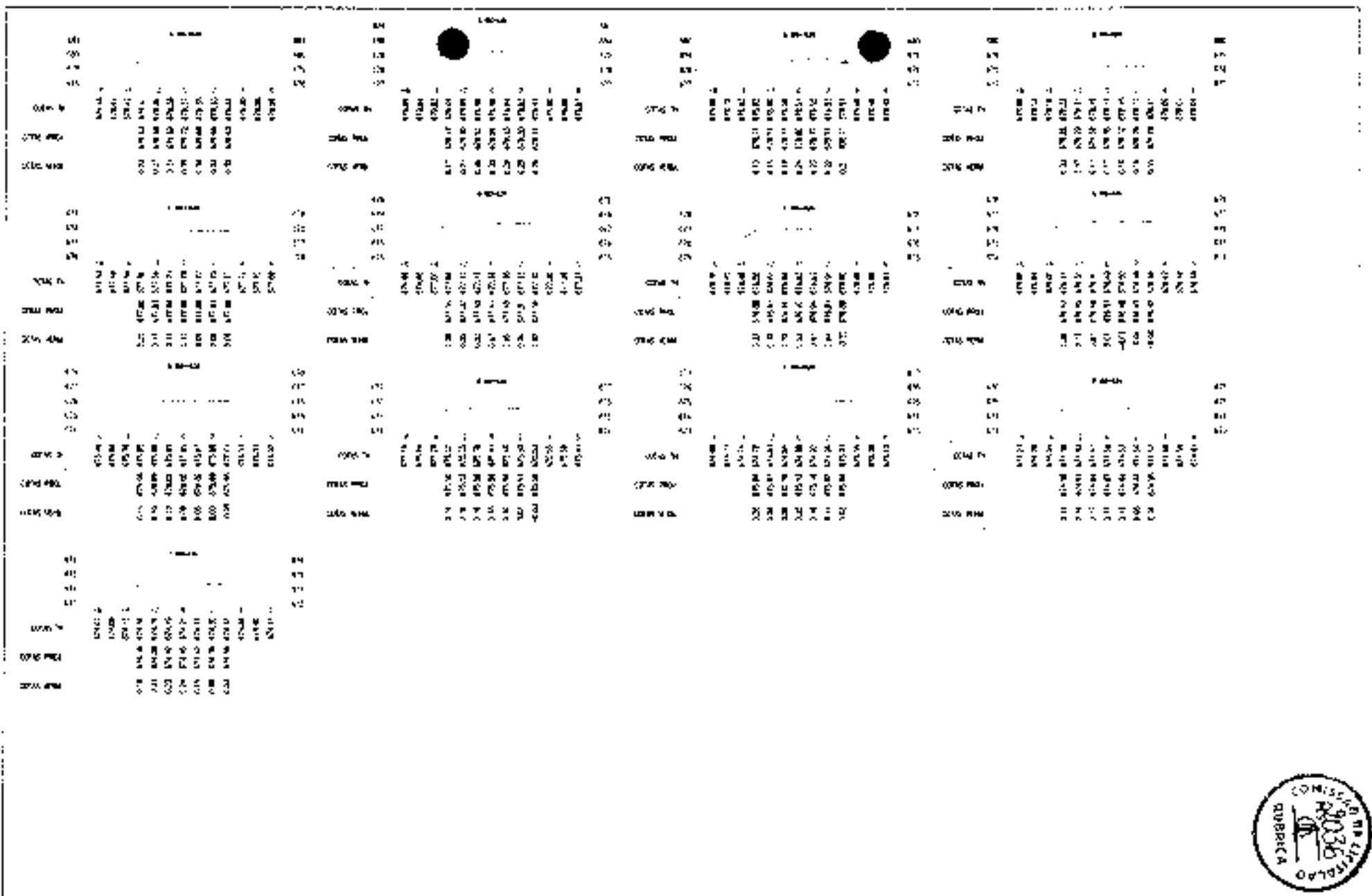



0 100m 200m

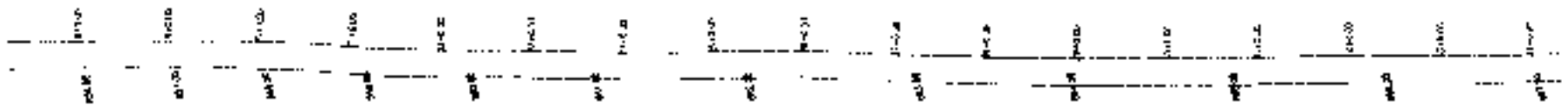
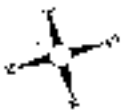

0 100m 200m



 JUCA BARRES ENGENHARIA	PREFEITURA MUNICIPAL DE GUARACIABA DO NORTE RECONSTRUÇÃO DE ESTRADAS VICINAIS NO MUNICÍPIO DE GUARACIABA DO NORTE - CE - PI 1886276-03		Nº 1 / 2
	SINALIZAÇÃO VIÁRIA		
DATA: _____ LOCAL: _____	PROJETO: _____ EXECUÇÃO: _____		DATA: _____ LOCAL: _____

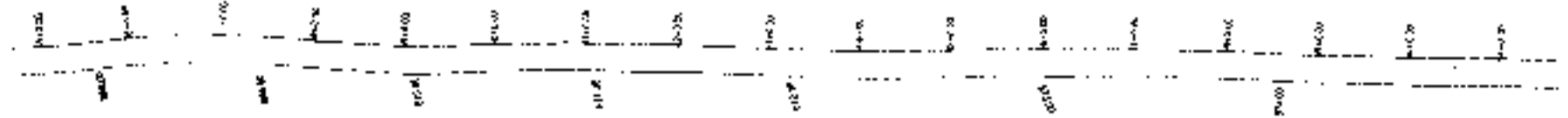
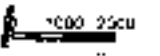

PREFEITURA MUNICIPAL DE GUARACABA DO NORTE
 RECUPERAÇÃO DE ESTRADAS VICINAIS NO VILAGEIO DE OLARADIARA
 DO MONTE-CE. F. 108270-03

SINALIZAÇÃO VIÁRIA

ÁREA: 137,6 m²
 DATA: 10/05/2011
 LOCAL: RUA A, RUA B, RUA C, RUA D, RUA E, RUA F, RUA G, RUA H, RUA I, RUA J, RUA K, RUA L, RUA M, RUA N, RUA O, RUA P, RUA Q, RUA R, RUA S, RUA T, RUA U, RUA V, RUA W, RUA X, RUA Y, RUA Z

2 / 21
 1:5000

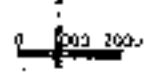

0 200 200 0

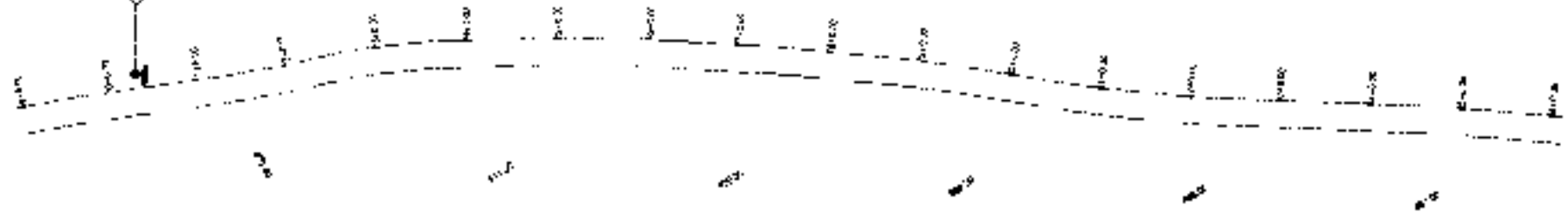
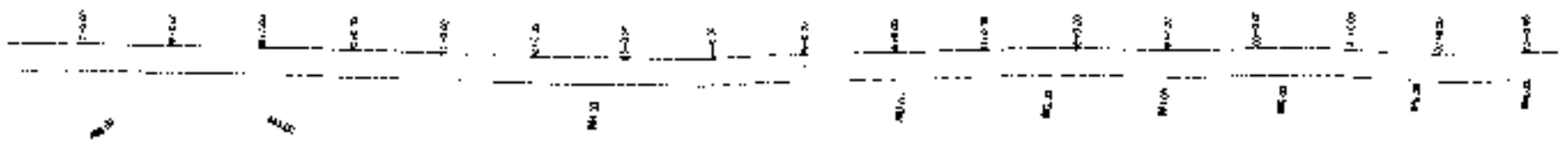

	PREFEITURA MUNICIPAL DE GLARCIÁBARA DO NORTE REQUALIFICAÇÃO DE ESTRADAS VICINAIS NO MUNICÍPIO DE GLARCIÁBARA DO NORTE - CE - PT 1086270-01		Nº 312
	SINALIZAÇÃO VIÁRIA		17/10/2011
	PROJETO DE SINALIZAÇÃO VIÁRIA PARA O TRÁFEGO DE VEÍCULOS E PEDESTRES		



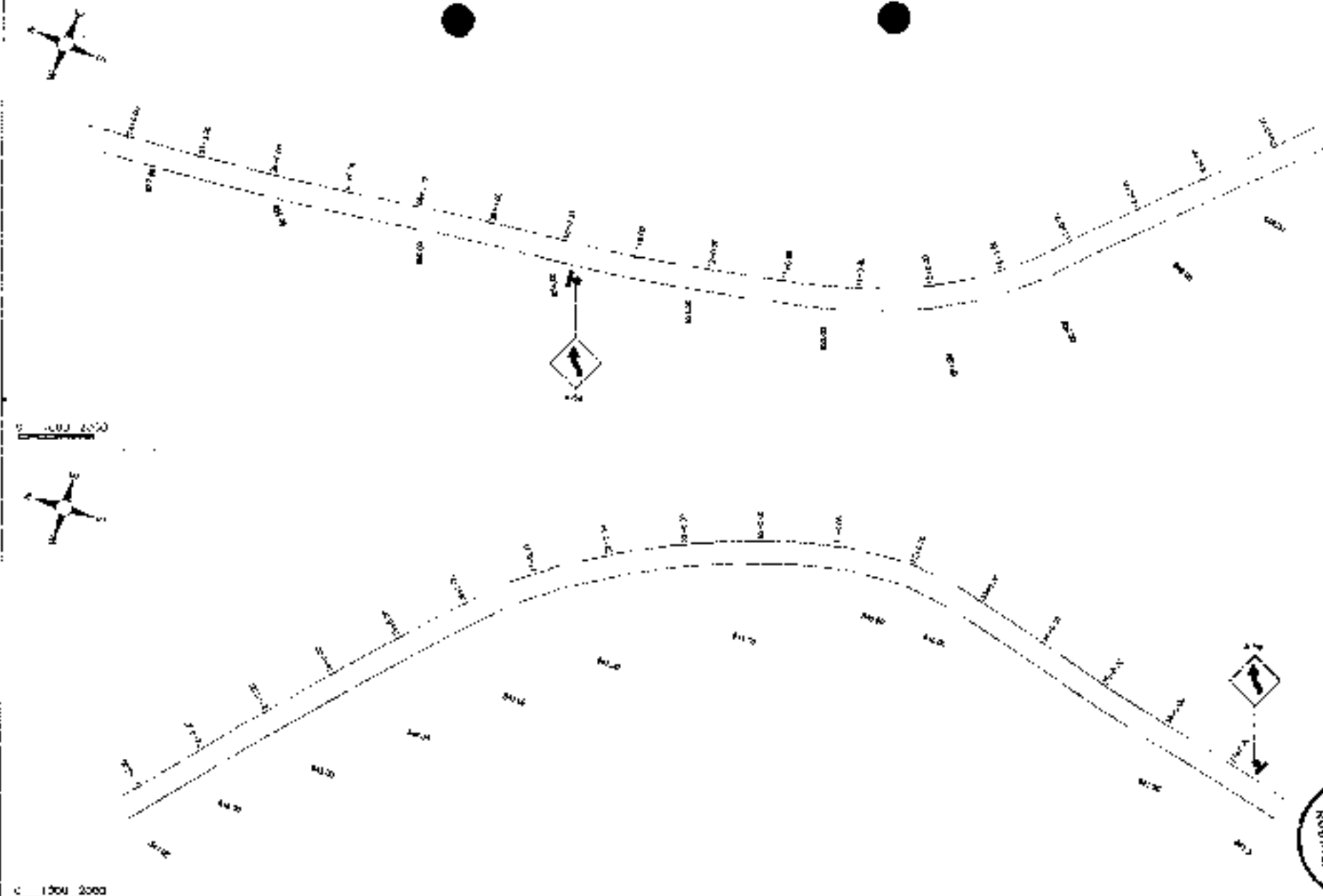

PREFEITURA MUNICIPAL DE GUARACIABA DO NORTE		4 / 2
RECUPERAÇÃO DE ESTRADAS VICIAIS NO MUNICÍPIO DE GUARACIABA DO NORTE - CE - PT 1086270-03		1:1000
SINALIZAÇÃO VIÁRIA		
PROJETO	ESTRADA VICIAIS - RECUPERAÇÃO - GUARACIABA DO NORTE	
LOCAL	1 - PÓLO INDUSTRIAL ADMS - GUARACIABA DO NORTE	

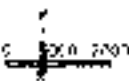

0 1000 2000

<p>JOTA BARROS ARQUITECTOS</p>	<p>FREIPEIRA MUNICIPAL DE JARACATABA DO NORTE</p>	612
	<p>RECUPERAÇÃO DE ESTRADAS VICINAIS NO MUNICÍPIO DE OLARIAEMA DO NORTE-CE - Pº 1086296/01</p>	
	<p>SINALIZAÇÃO VIÁRIA</p>	
	<p>PROPOSTA DE SINALIZAÇÃO VIÁRIA</p>	



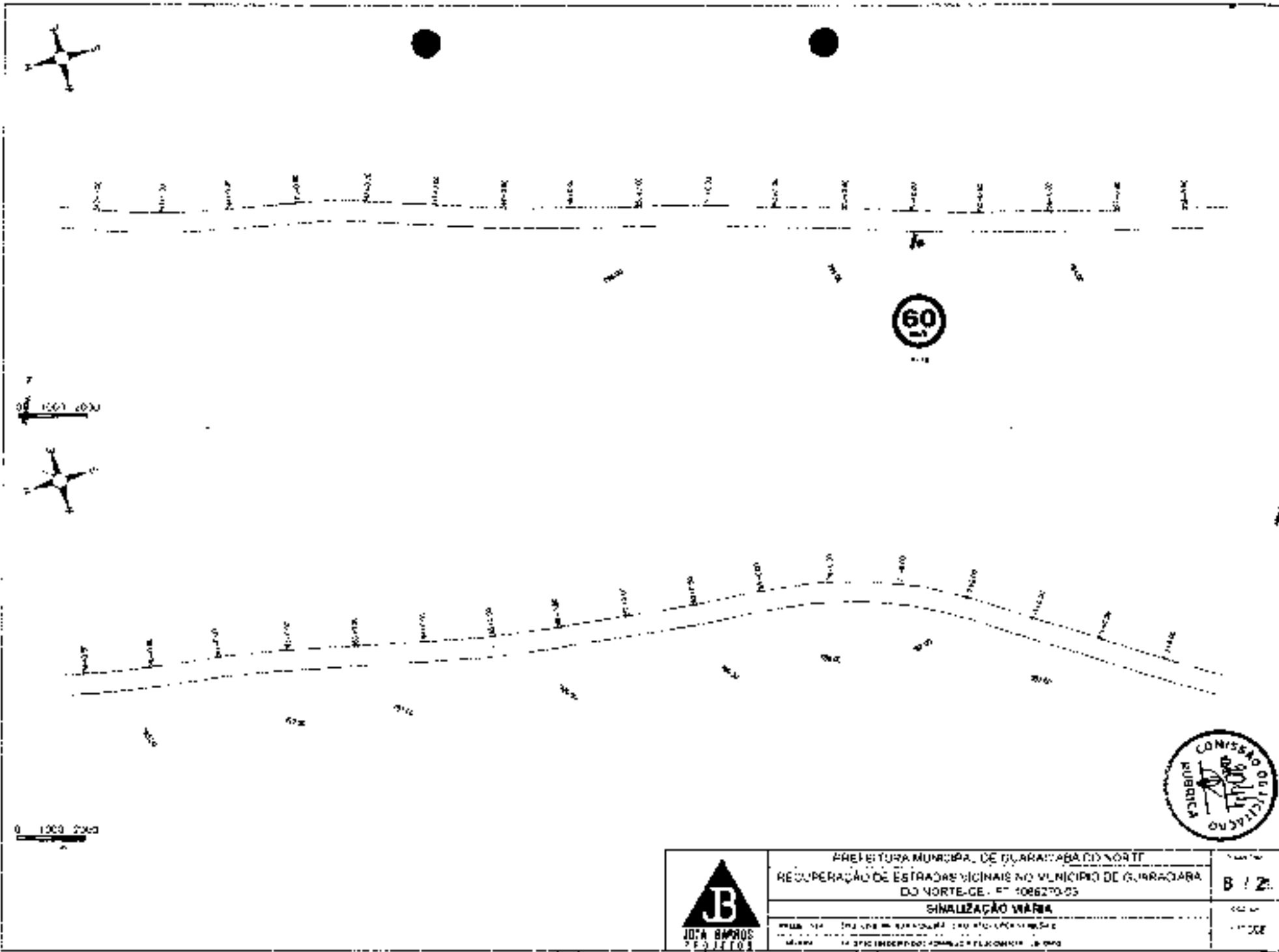

 <p>JOTA BARROS ENGENHARIA</p>	<p>PREFEITURA MUNICIPAL DE GUARABARA DO NORTE</p> <p>RECUPERAÇÃO DE ESTRADAS VICINAIS NO MUNICÍPIO DE GUARABARA DO NORTE-CE - R# 4086270-03</p> <p>SINALIZAÇÃO VIÁRIA</p>		<p>1/2024</p>
	<p>PROJETO DE: [Illegible]</p> <p>REVISÃO: [Illegible]</p>		<p>B / 2</p>

1:5000



1000 2000

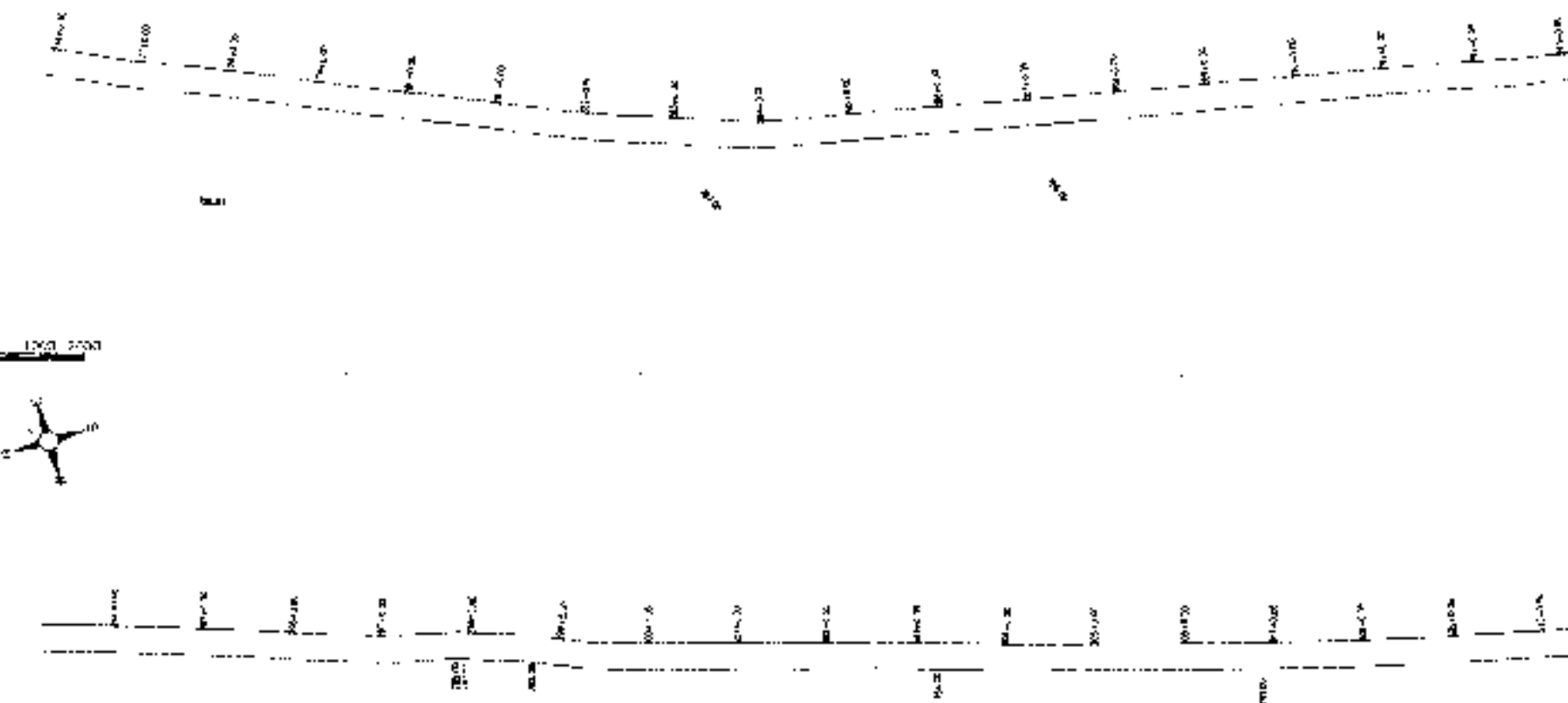

PREFEITURA MUNICIPAL DE GUARACIABA DO NORTE
 RECUPERAÇÃO DE ESTRADAS VICINAIS NO MUNICÍPIO DE GUARACIABA DO NORTE - CE - P.º 086270-03
 SINALIZAÇÃO VÁRIA



9 / 21
 1:5000



1:2000 ESCALA

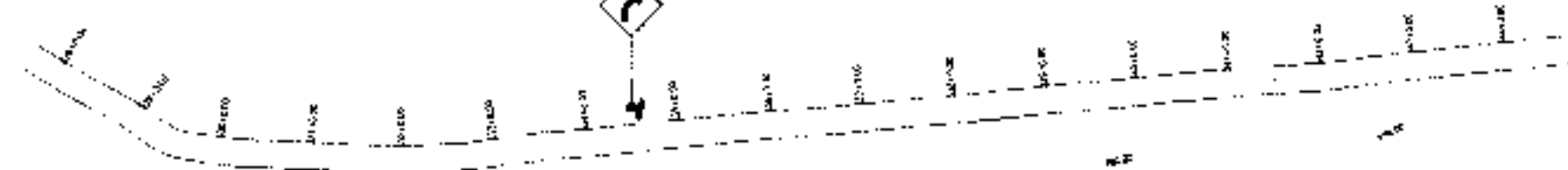

1:2000 ESCALA



PREFEITURA MUNICIPAL DE GUARACIABA DO NORTE		10 / 2
REQUALIFICAÇÃO DE ESTRADAS VICINAIS NO MUNICÍPIO DE GUARACIABA DO NORTE-CE - P1 12862/0-03		
SINALIZAÇÃO VIÁRIA		
PROJETO DE:	PAULO CARLOS NORONHA FERREIRA - ATIVIDADE 1	1:2000
EMPRESA:	OPAS SARGOS ENGENHARIA E PROJETOS	

0 1000 2000

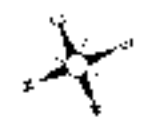

0 1000 2000

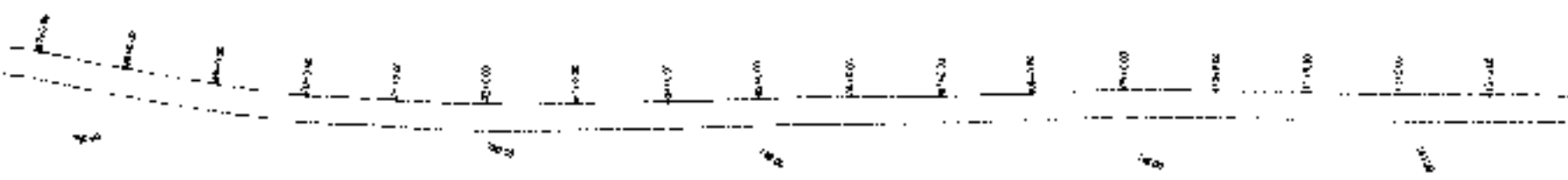
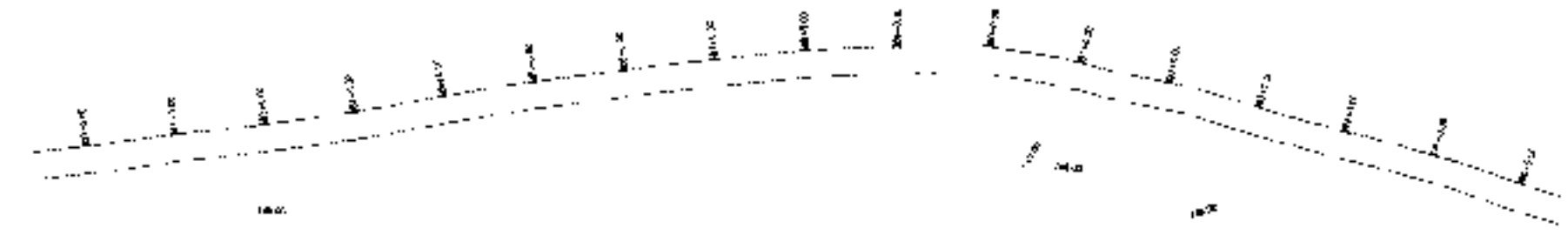

PREFEITURA MUNICIPAL DE GUARACABA DO NORTE
 RECUPERAÇÃO DE ESTRADAS MUNICIPAIS NO MUNICÍPIO DE GUARACABA DO NORTE - CE - FT 1085070-00
 SINALIZAÇÃO VIÁRIA

12 / 2
 1:1000

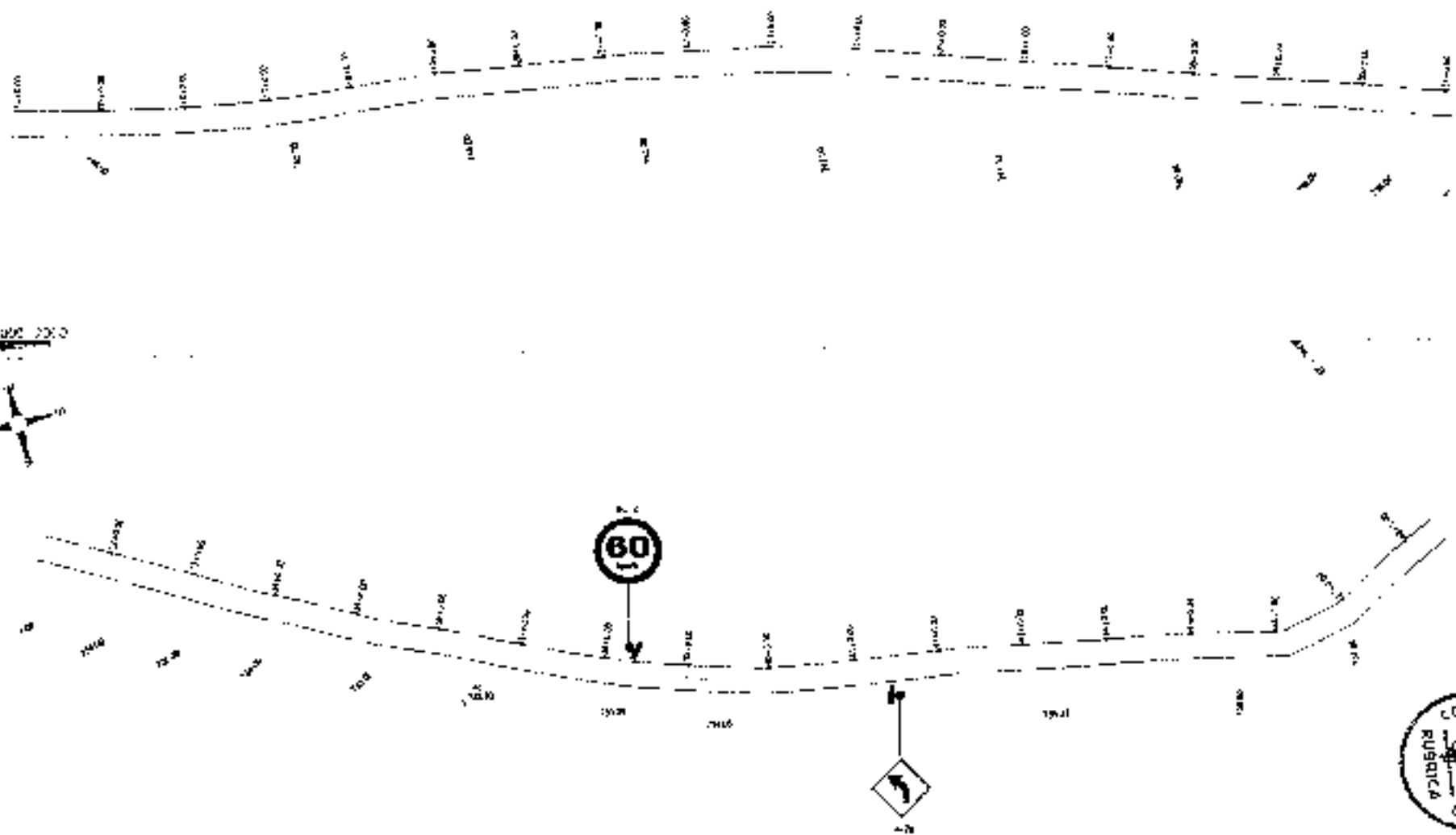

PREFEITURA MUNICIPAL DE GUARACIABA DO NORTE
 RECUPERAÇÃO DE ESTRADAS VICINAIS NO MUNICÍPIO DE GUARACIABA DO NORTE - CE - PT 1086270-03
 SINALIZAÇÃO VIÁRIA

PROJETO: [illegible]
 EXECUÇÃO: [illegible]

1312
 2007

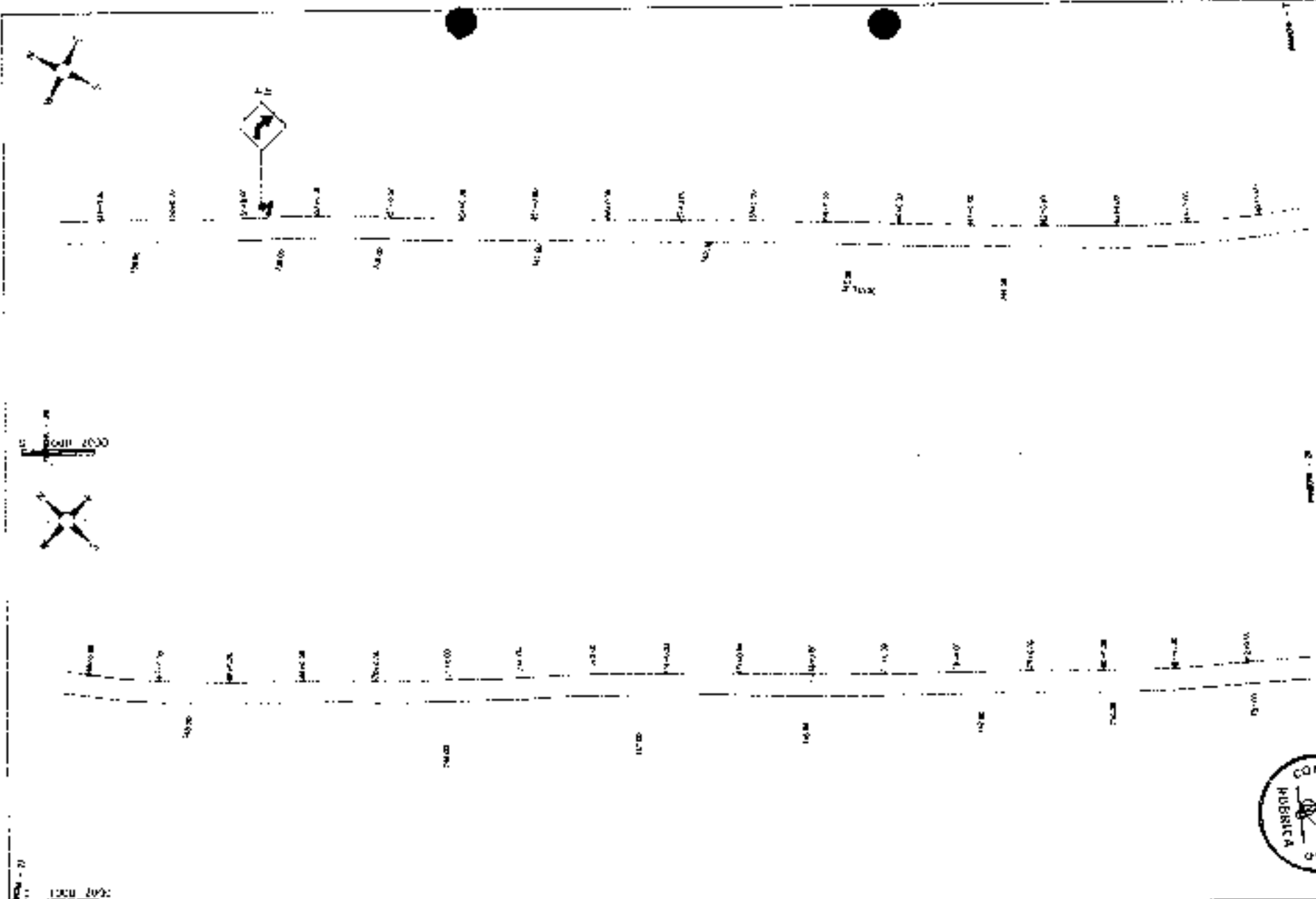

PREFEITURA MUNICIPAL DE GUARACIÁ DO NORTE RECUPERAÇÃO DE ESTRADAS MUNICIPAIS NO MUNICÍPIO DE GUARACIÁ DO NORTE - CE - Nº 1086274-03		Nº 14 / 21
SINALIZAÇÃO VIÁRIA		DATA 17/08
PROJETO	LDBA BARROS	LOCAL
EXECUÇÃO	LDBA BARROS	DATA



1:500

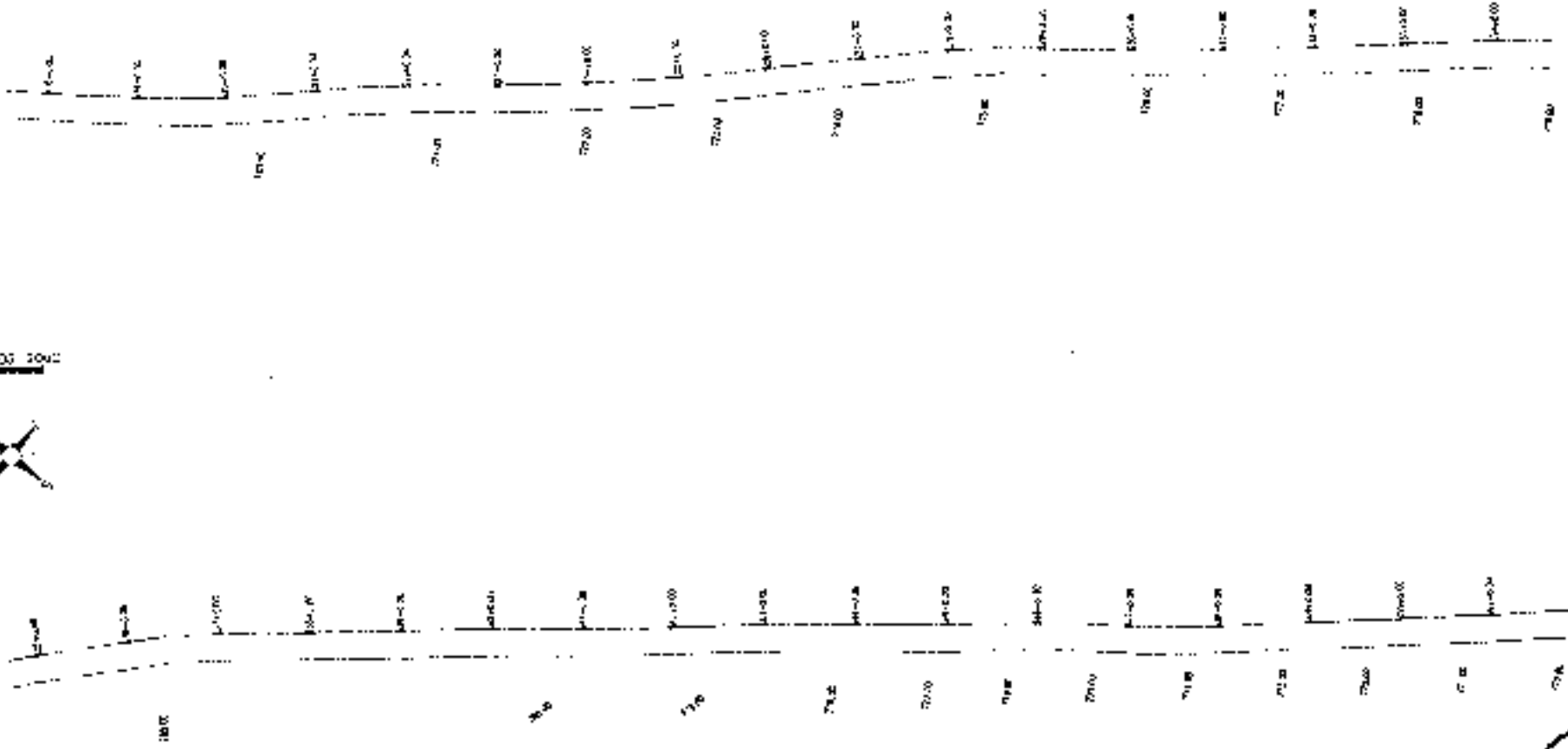

	PREFEITURA MUNICIPAL DE GUARACIABA DO NORTE		16 / 21
	RECUPERAÇÃO DE ESTRADAS VICINAIS NO MUNICÍPIO DE GUARACIABA DO NORTE DE - PT 102470-23		1:1000
	SINALIZAÇÃO VERTICAL		1:1000
	PROJETO DE SINALIZAÇÃO VERTICAL PARA O PROJETO DE RECUPERAÇÃO DE ESTRADAS VICINAIS NO MUNICÍPIO DE GUARACIABA DO NORTE DE - PT 102470-23		



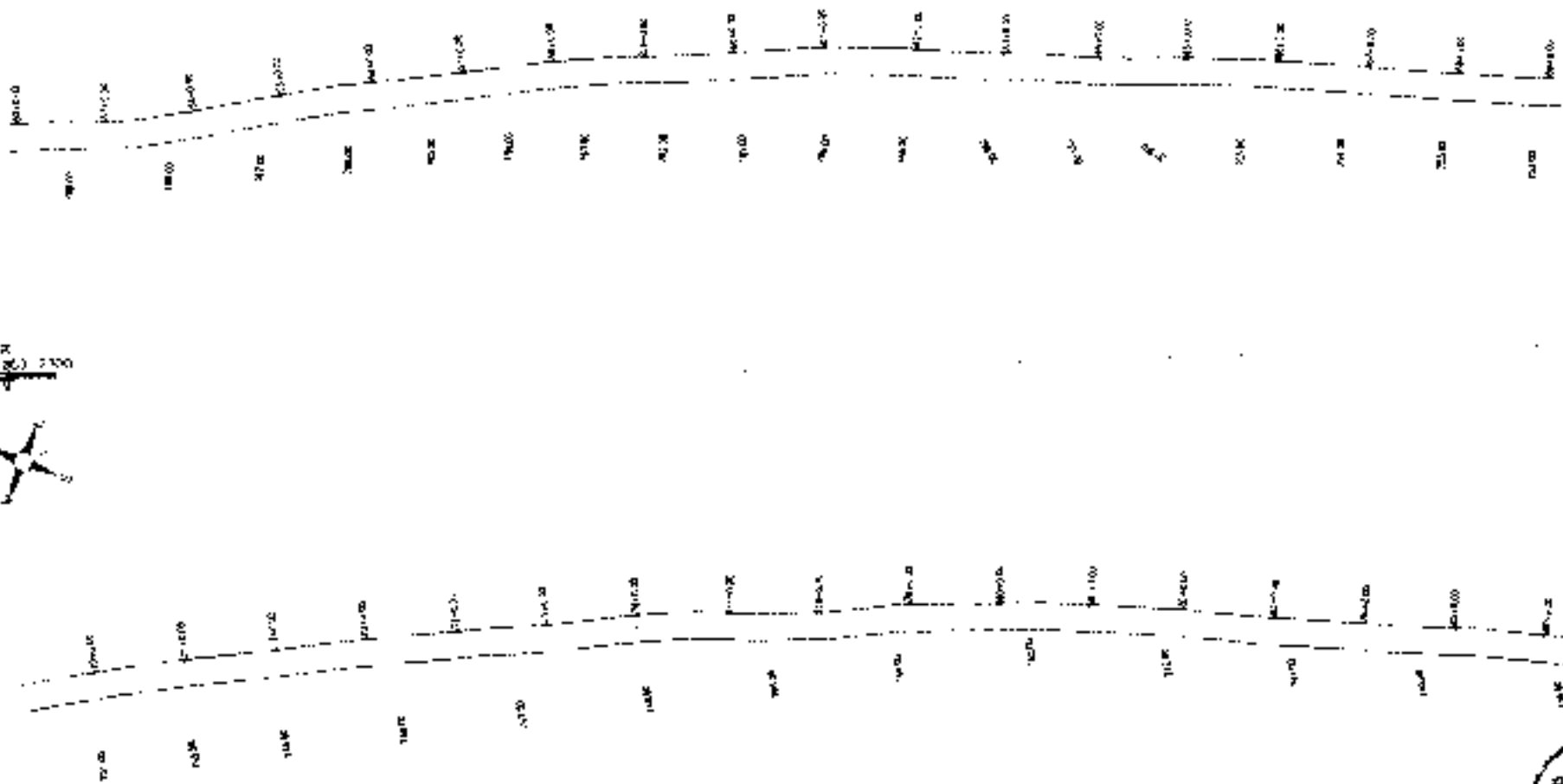
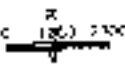
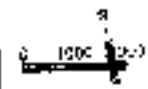



PREFEITURA MUNICIPAL DE GUARACIABA DO NORTE
 RECUPERAÇÃO DE ESTRADAS VICIAIS NO MUNICÍPIO DE GUARACIABA DO NORTE-DE - PT 108270-03
 SINALIZAÇÃO VIÁRIA

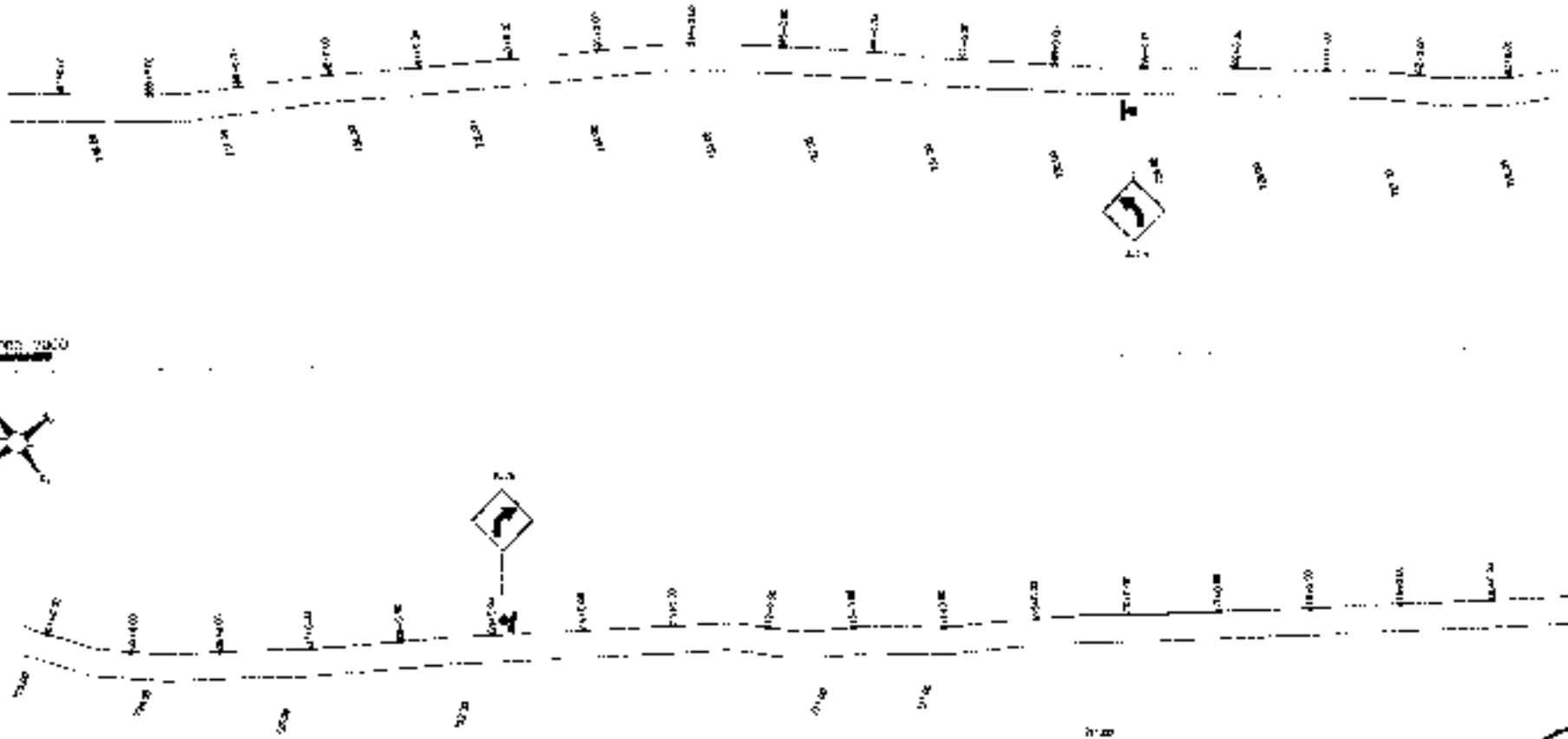
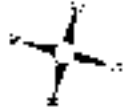

17 / 21
 11/08

1:200 20%



 <p>NOTA BARÃO DE ITAIPAVA</p>	PREFEITURA MUNICIPAL DE GLARCIABA DO NORTE RECUPERAÇÃO DE ESTRADAS VICINAIS AO MUNICÍPIO DE GLARCIABA DO NORTE-CE - PT 1086270403		18 / 2
	SINALIZAÇÃO VIÁRIA		1:1000
PROJETO:	ENG. CAR. MARCELO ATAL (086270403) - 1987-1987-22		
EXECUÇÃO:	CONSULTORIA TÉCNICA: COMP. DE TRAFEGO - 1987-1987-22		





0 1000 2000

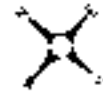

0 1000 2000

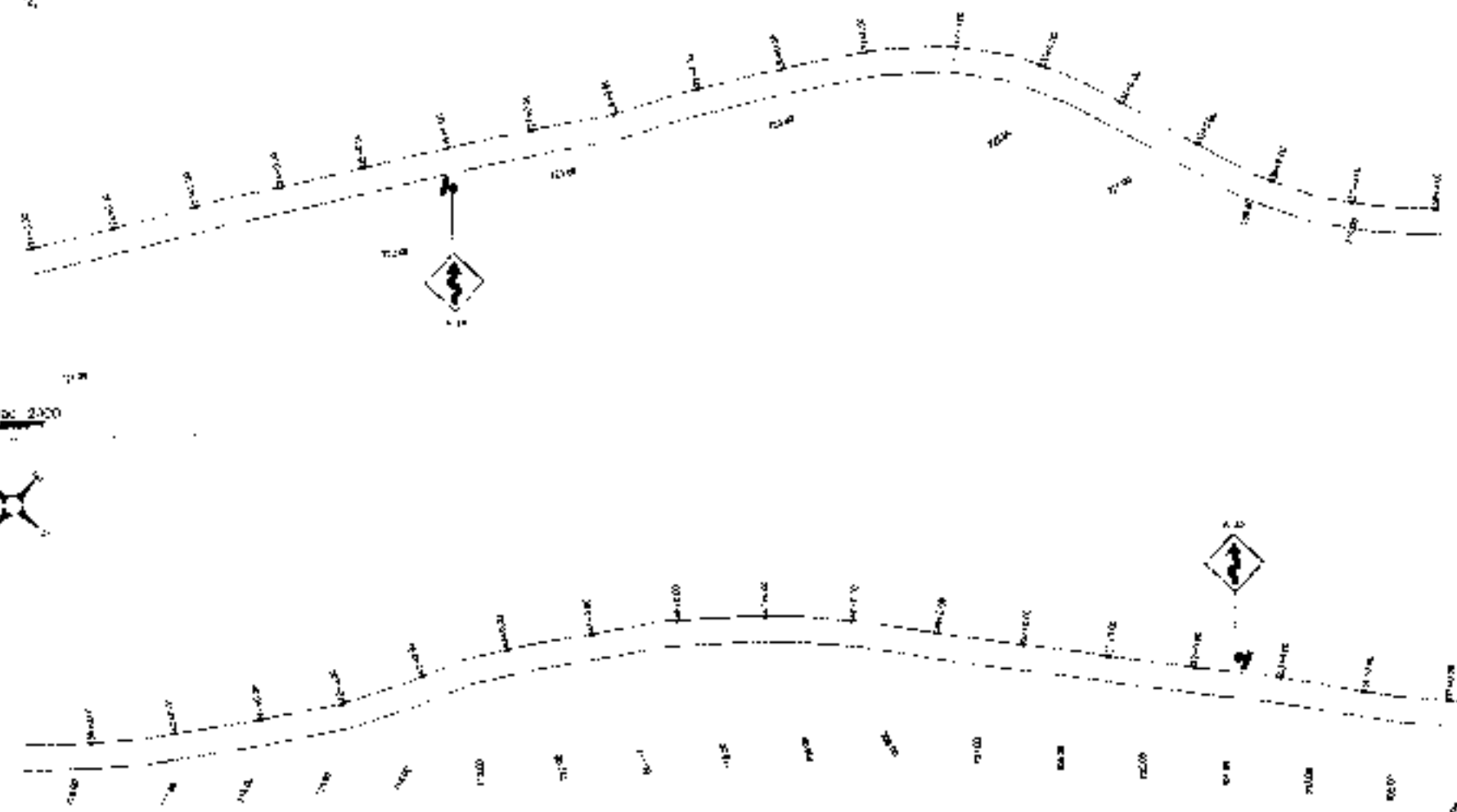

PREFEITURA MUNICIPAL DE GUARAJAZA DO NORTE	
RECUPERAÇÃO DE ESTRADAS VICINAIS NO MUNICÍPIO DE GUARAJAZA DO NORTE-CE - PT. 108E2/0403	
SINALIZAÇÃO VIÁRIA	
PROJETO	ELABORADO POR: JUCA BARROS PROJETOS
ANEXO	PLANO DE TRABALHO DE SINALIZAÇÃO VIÁRIA



19 / 21
11/2008

Posicionamento transversal

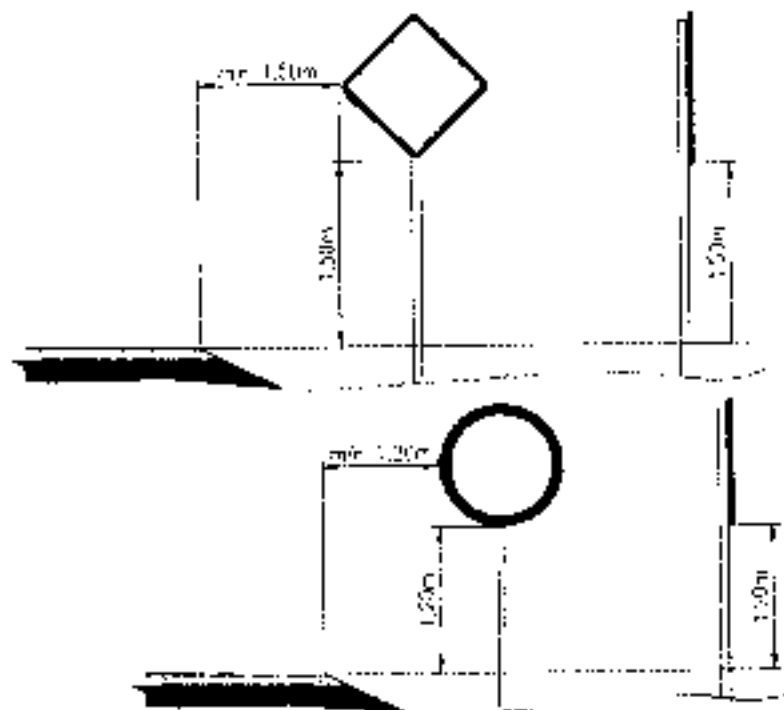

PLACAS DE ADVERTENCIA

PLACAS	CODIGO	DIMENSÃO (m)	PLACAS (m)
	0201	1,00x1,10	1,10
	0202	1,00x1,10	1,10
	0203	1,00x1,10	1,10
	0204	1,00x1,10	1,10
	0205	1,00x1,10	1,10
	0206	1,00x1,10	1,10
	0207	1,00x1,10	1,10

PLACAS DE ADVERTENCIA

PLACAS	CODIGO	DIMENSÃO (m)	PLACAS (m)
	0208	0,50x0,50	0,50

As Placas de Advertência devem ser colocadas com antecedência suficiente para que os condutores possam tomar as devidas precauções. A distância mínima entre as placas deve ser de 100m.

As Placas de Advertência têm as seguintes características:
 Cor - Amarela
 Forma - Triângulo Equilátero
 Símbolo - Preto
 Fundo - Branco
 Dimensão - 1,00m
 Altura - 1,10m



PREFEITURA MUNICIPAL DE GUARACIABA DO NORTE

RECUPERAÇÃO DE ESTRADAS VICINAIS NO MUNICÍPIO DE GUARACIABA DO NORTE-CE - P1 1088274-03

SINALIZAÇÃO VIÁRIA

PROPOSTA Nº 01/2018

EMPRESA: JOTA BARBOS PROJETOS

VALOR: R\$ 1.000,00

DATA: 21/02/2018

SEN L.T.



1:1000 2000

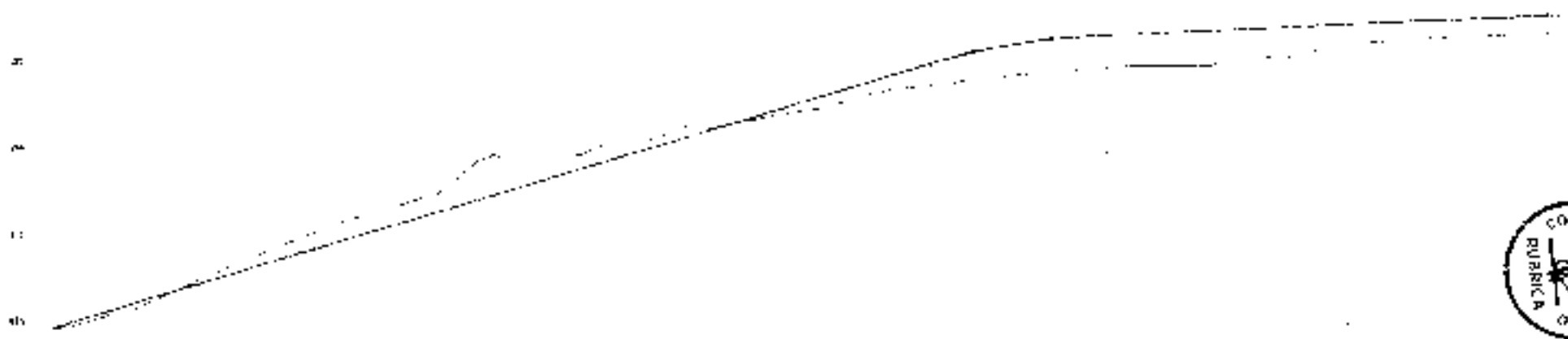

1	2	3	4	5	6	7	8	9	10	11	12	13	14	15	16	17	18	19	20
100	100	100	100	100	100	100	100	100	100	100	100	100	100	100	100	100	100	100	100
100	100	100	100	100	100	100	100	100	100	100	100	100	100	100	100	100	100	100	100





JOTA BARROS
FAC - EGE

PREFEITURA MUNICIPAL DE GUARACIABA (DO) NORTE

RECUPERAÇÃO DE ESTRADAS VICINAIS NO MUNICÍPIO DE GUARACIABA DO NORTE-CE - PT 100R210-03

ESTAQUEAMENTO E PERFIL LONGITUDINAL

1 / 07

H 1.1000

V 1.1000

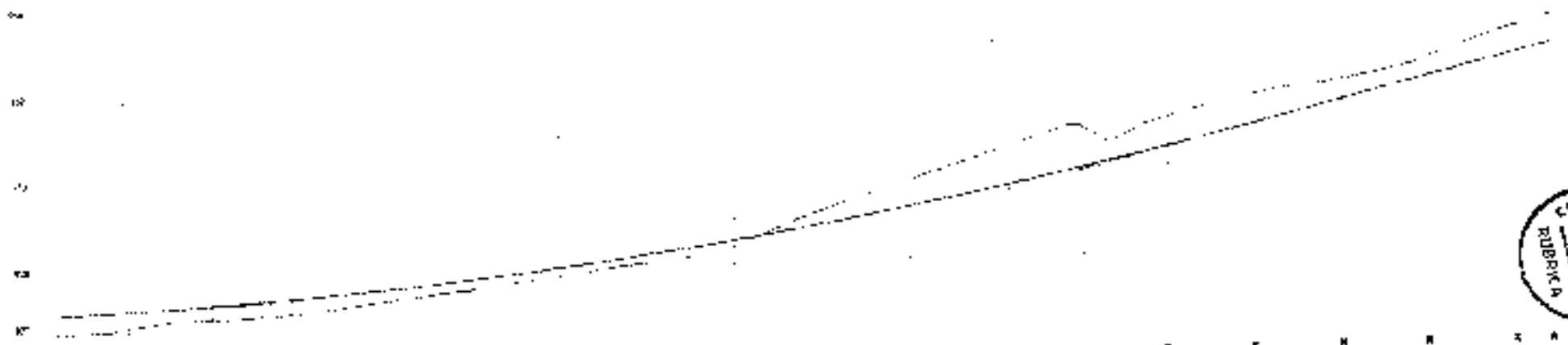
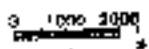

1+00	1+05	1+10	1+15	1+20	1+25	1+30	1+35	1+40	1+45	1+50	1+55	1+60	1+65	1+70	1+75	1+80	1+85	1+90	1+95	2+00
------	------	------	------	------	------	------	------	------	------	------	------	------	------	------	------	------	------	------	------	------



PREFEITURA MUNICIPAL DE GUARACIABA DO NORTE
 RECUPERAÇÃO DE ESTRADAS VICINAIS NO MUNICÍPIO DE GUARACIABA DO NORTE-CE - PT 1080273-03
 ESTADOURAMENTO E PERFIL LONGITUDINAL

PROJETO	ESTADOURAMENTO E PERFIL LONGITUDINAL
FECHA	10/05/2010
LOCAL	GUARACIABA DO NORTE - CE



ESCALA
2 / 07
 1:1000
 1:1000

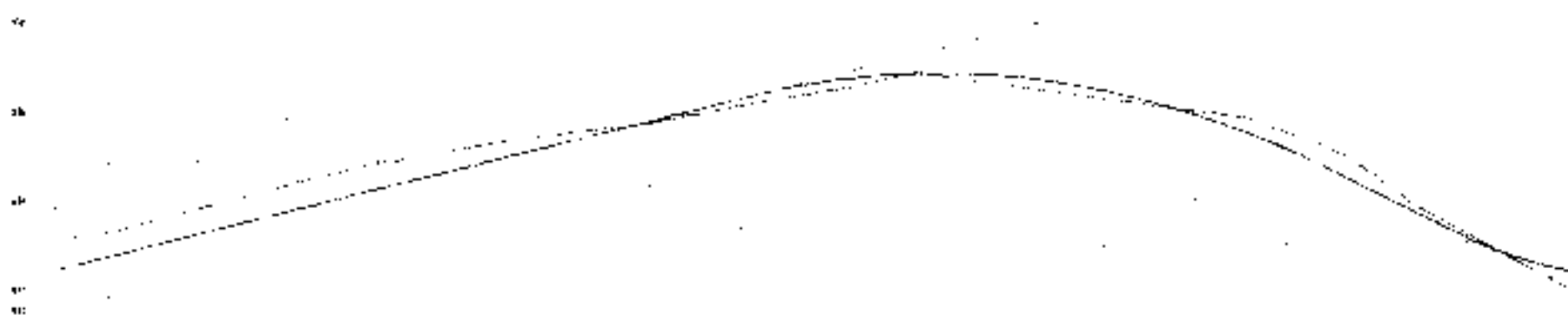
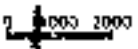
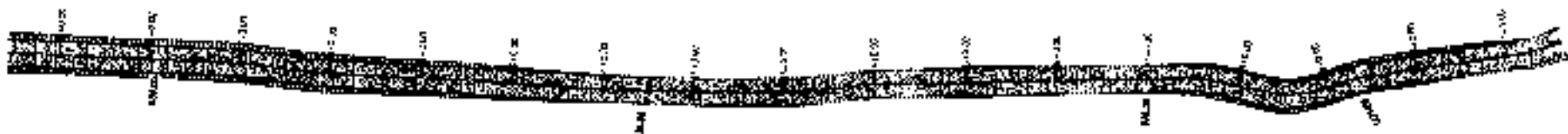

1+00	1+20	1+40	1+60	1+80	2+00	2+20	2+40	2+60	2+80	3+00	3+20	3+40	3+60	3+80	4+00	4+20	4+40	4+60	4+80	5+00	5+20	5+40	5+60	5+80	6+00	6+20	6+40	6+60	6+80	7+00	7+20	7+40	7+60	7+80	8+00	8+20	8+40	8+60	8+80	9+00	9+20	9+40	9+60	9+80	10+00
------	------	------	------	------	------	------	------	------	------	------	------	------	------	------	------	------	------	------	------	------	------	------	------	------	------	------	------	------	------	------	------	------	------	------	------	------	------	------	------	------	------	------	------	------	-------

ASfalto	Concreto	Gravilha	Terra	Pedra	Sabão	Água	Utilidade Pública

 JOÃO BARROS PAES JR.	PREFEITURA MUNICIPAL DE GUARACIABA DO NORTE RECUPERAÇÃO DE ESTRADAS VICINAIS NO MUNICÍPIO DE GUARACIABA DO NORTE-CE - PT 1086270-03		FOLHA 3 / 07
	ESTAQUEAMENTO E PERFIL LONGITUDINAL		DATA 11/11/2002 V 1:100



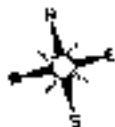

1:1000 2000

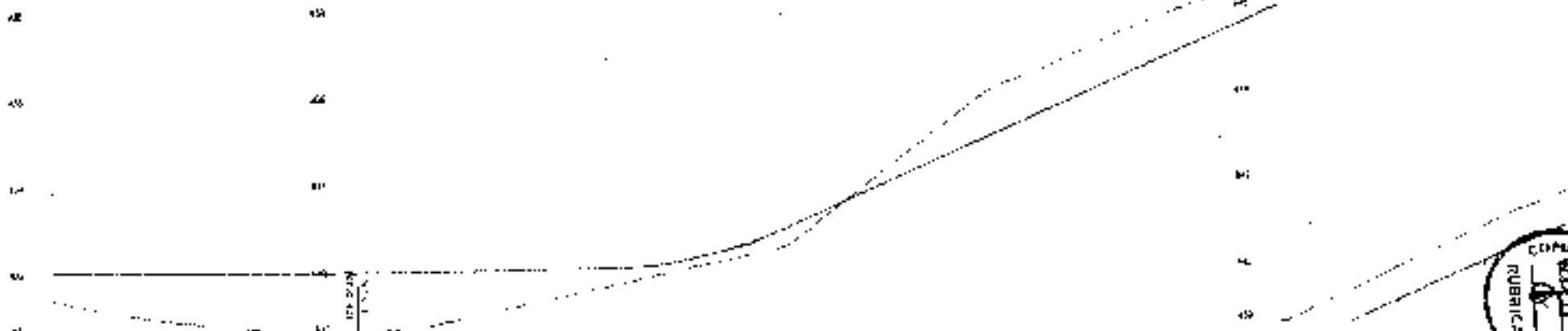

1	2	3	4	5	6	7	8	9	10	11	12	13	14	15	16	17	18	19	20	21	22	23	24	25	26	27	28	29	30	31	32	33	34	35	36	37	38	39	40	41	42	43	44	45	46	47	48	49	50	51	52	53	54	55	56	57	58	59	60	61	62	63	64	65	66	67	68	69	70	71	72	73	74	75	76	77	78	79	80	81	82	83	84	85	86	87	88	89	90	91	92	93	94	95	96	97	98	99	100	
0+00	0+10	0+20	0+30	0+40	0+50	0+60	0+70	0+80	0+90	1+00	1+10	1+20	1+30	1+40	1+50	1+60	1+70	1+80	1+90	2+00	2+10	2+20	2+30	2+40	2+50	2+60	2+70	2+80	2+90	3+00	3+10	3+20	3+30	3+40	3+50	3+60	3+70	3+80	3+90	4+00	4+10	4+20	4+30	4+40	4+50	4+60	4+70	4+80	4+90	5+00	5+10	5+20	5+30	5+40	5+50	5+60	5+70	5+80	5+90	6+00	6+10	6+20	6+30	6+40	6+50	6+60	6+70	6+80	6+90	7+00	7+10	7+20	7+30	7+40	7+50	7+60	7+70	7+80	7+90	8+00	8+10	8+20	8+30	8+40	8+50	8+60	8+70	8+80	8+90	9+00	9+10	9+20	9+30	9+40	9+50	9+60	9+70	9+80	9+90	10+00

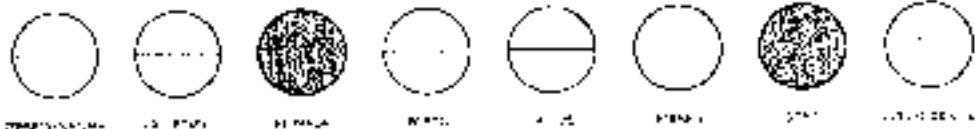

PREFEITURA MUNICIPAL DE GUARACIABA DO NORTE

RECUPERAÇÃO DE ESTRADAS VICINAIS NO MUNICÍPIO DE GUARACIABA DO NORTE-CE - FT 1086270-23

ESTAQUEAMENTO E PERFIL LONGITUDINAL

PROJETO: ESTACIONAMENTO E PERFIL LONGITUDINAL

ARTEIRO: JOTA BARROS PROJETOS

4 / 07

ESCALA: H 1:1000 V 1:1000

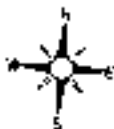

PREFEITA - S

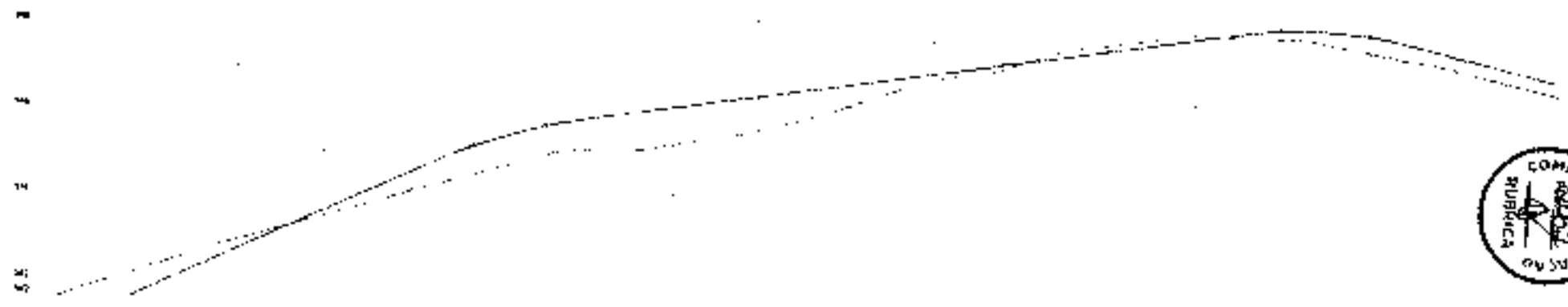
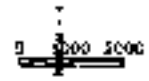

0+00	0+100	0+200	0+300	0+400	0+500	0+600	0+700	0+800	0+900	1+000	1+100	1+200	1+300
0.00	0.00	0.00	0.00	0.00	0.00	0.00	0.00	0.00	0.00	0.00	0.00	0.00	0.00
0.00	0.00	0.00	0.00	0.00	0.00	0.00	0.00	0.00	0.00	0.00	0.00	0.00	0.00
0.00	0.00	0.00	0.00	0.00	0.00	0.00	0.00	0.00	0.00	0.00	0.00	0.00	0.00

ALCANTARAL	SUBGRANDE	LEITÃO	ASPH	VALE	VALE	VALE	VALE



PREFEITURA MUNICIPAL DE GUARACIABA DO NORTE		MEMORIA
RECUPERAÇÃO DE ESTRADAS VICINAIS NO MUNICÍPIO DE GUARACIABA DO NORTE-AC - FT 1056270-03		5 / 07
ESTAQUEAMENTO E PERFIL LONGITUDINAL		
PROJETO	PROJETO DE RECUPERAÇÃO DE ESTRADAS VICINAIS	ESCALA
FECHA	10/05/2010	1:1000
		V:1130



1:1000 2000

10
5
0
-5
-10
-15

10	9	8	7	6	5	4	3	2	1	0	1	2	3	4	5	6	7	8	9	10
10	9	8	7	6	5	4	3	2	1	0	1	2	3	4	5	6	7	8	9	10
10	9	8	7	6	5	4	3	2	1	0	1	2	3	4	5	6	7	8	9	10

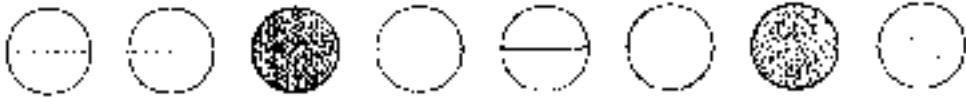

PREFEITURA MUNICIPAL DE GUARACIABA DO NORTE
 RECUPERAÇÃO DE ESTRADAS VICINAS NO MUNICÍPIO DE GUARACIABA DO NORTE - CE - FT 1086270-03
 ESTAQUEAMENTO E PERFIL LONGITUDINAL
 ESCALA: 1:1000
 DATA: 10/06/2010

6 / 07
 H = 1000
 V = 1/100

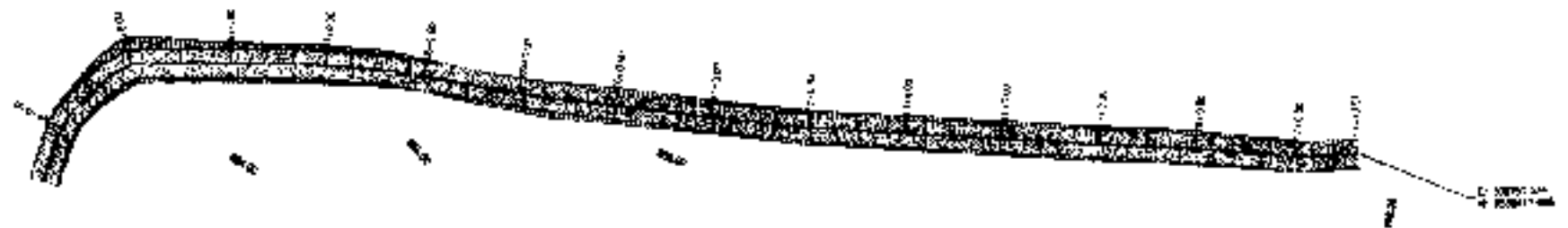

1:1000 2000

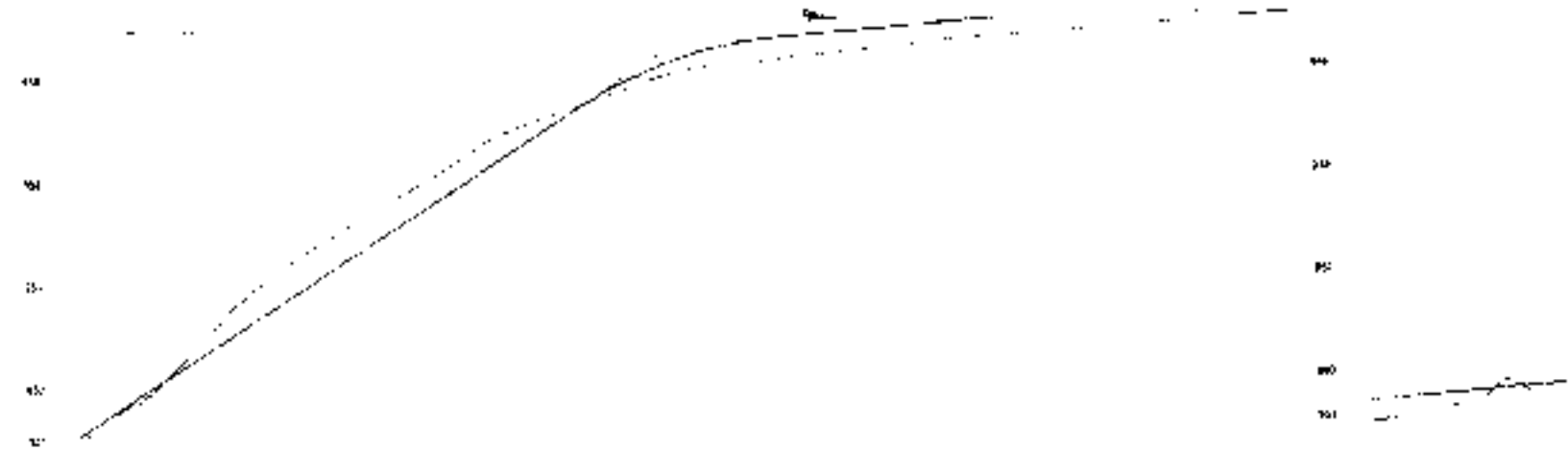

1	2	3	4	5	6	7	8	9	10	11	12	13	14	15	16	17	18	19	20
100	100	100	100	100	100	100	100	100	100	100	100	100	100	100	100	100	100	100	100
100	100	100	100	100	100	100	100	100	100	100	100	100	100	100	100	100	100	100	100





PREFEITURA MUNICIPAL DE GUARACIABA DO NORTE
 RECUPERAÇÃO DE ESTRADAS VICINAIS NO MUNICÍPIO DE GUARACIABA DO NORTE - CC - PT 10882704-3
ESTAQUEAMENTO E PERFIL LONGITUDINAL
 Nº PROJETO: 25 - 10882704-3
 Nº LICITAÇÃO: 001/2010
 DATA: 12/04/2010

7 / 07
 ESCALA
 H 1 1000
 V 1'100

LEGENDA

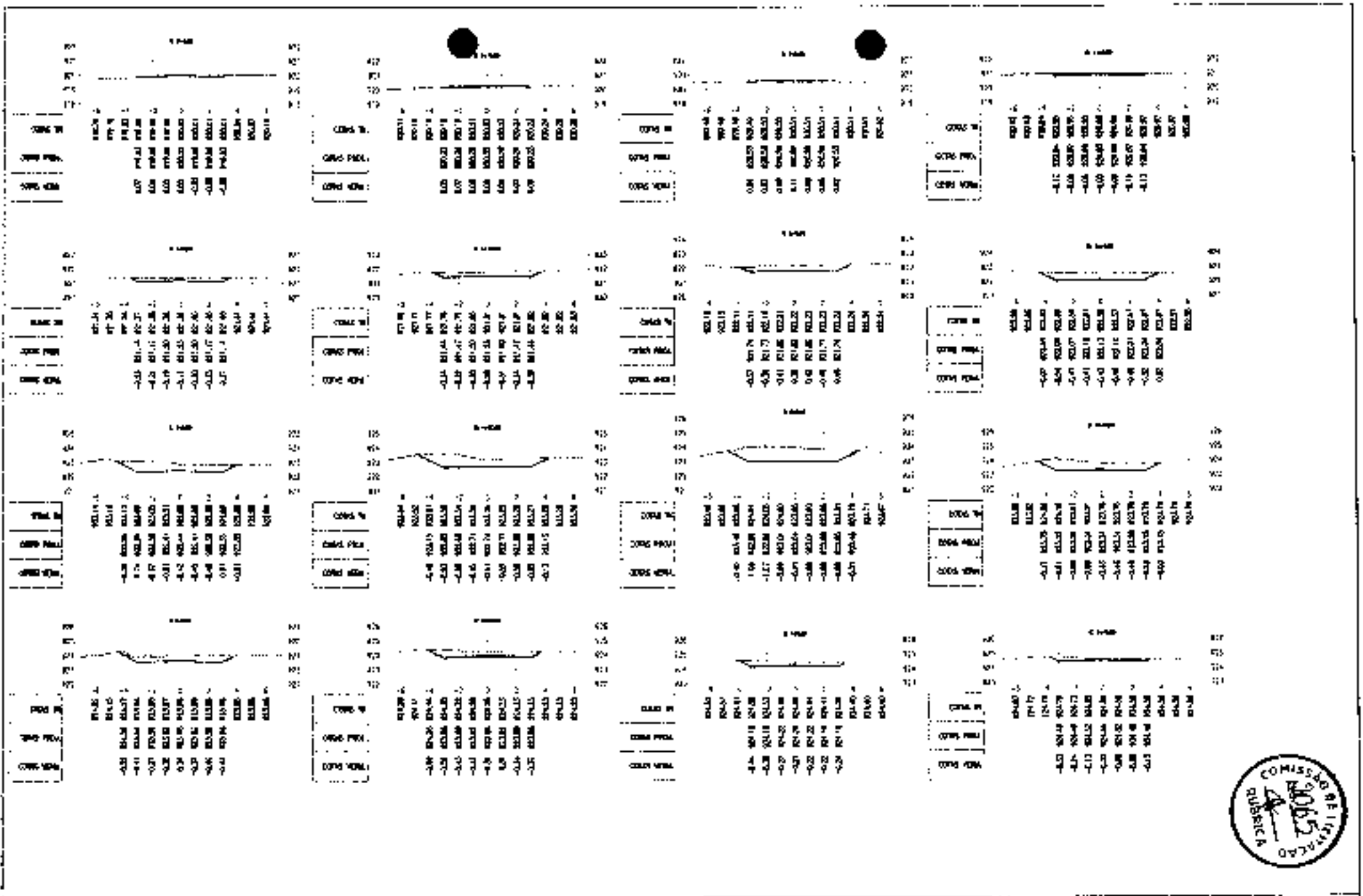

-  ATERRO
-  CORTE





	PREFEITURA MUNICIPAL DE GUARACIABA DO NORTE RECUPERAÇÃO DE ESTRADAS VICINAIS NO MUNICÍPIO DE GUARACIABA DO NORTE-CE - PT 1086271-003		FOLHA Nº 1 / 17
	SEÇÕES TRANSVERSAIS		ESCALA 1:250
	DATA: 10/05/2011	PROJETO: 1086271-003	LOCAL: GUARACIABA DO NORTE - CE



LEGENDA:

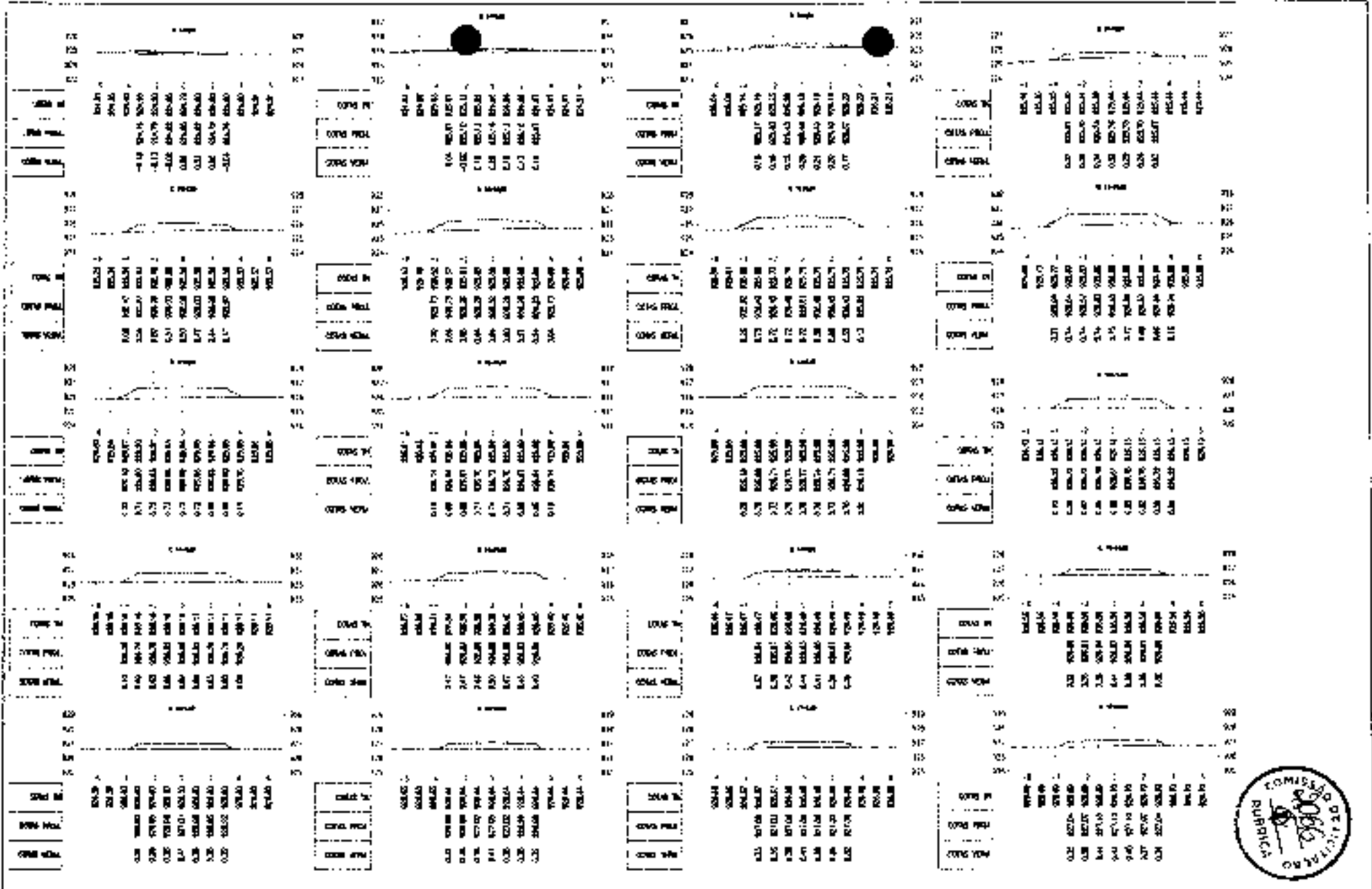

-  ATERRO
-  CORTE



 <p>JOTA BARROS PROJETOS</p>	PREFEITURA MUNICIPAL DE GUARACAMA DO NORTE RECUPERAÇÃO DE ESTRADAS VICINAIS NO MUNICÍPIO DE GUARACAMA DO NORTE - CE - PT 1.086.770-03		FOLHA Nº 2 / 17
	SEÇÕES TRANSVERSAIS		ESCALA 1:250
	DATA DE EMISSÃO DO PROJETO: 10/05/2017		DATA DE APROVAÇÃO DO PROJETO: 10/05/2017



LEGENDA

-  ATERRO
-  CORTE



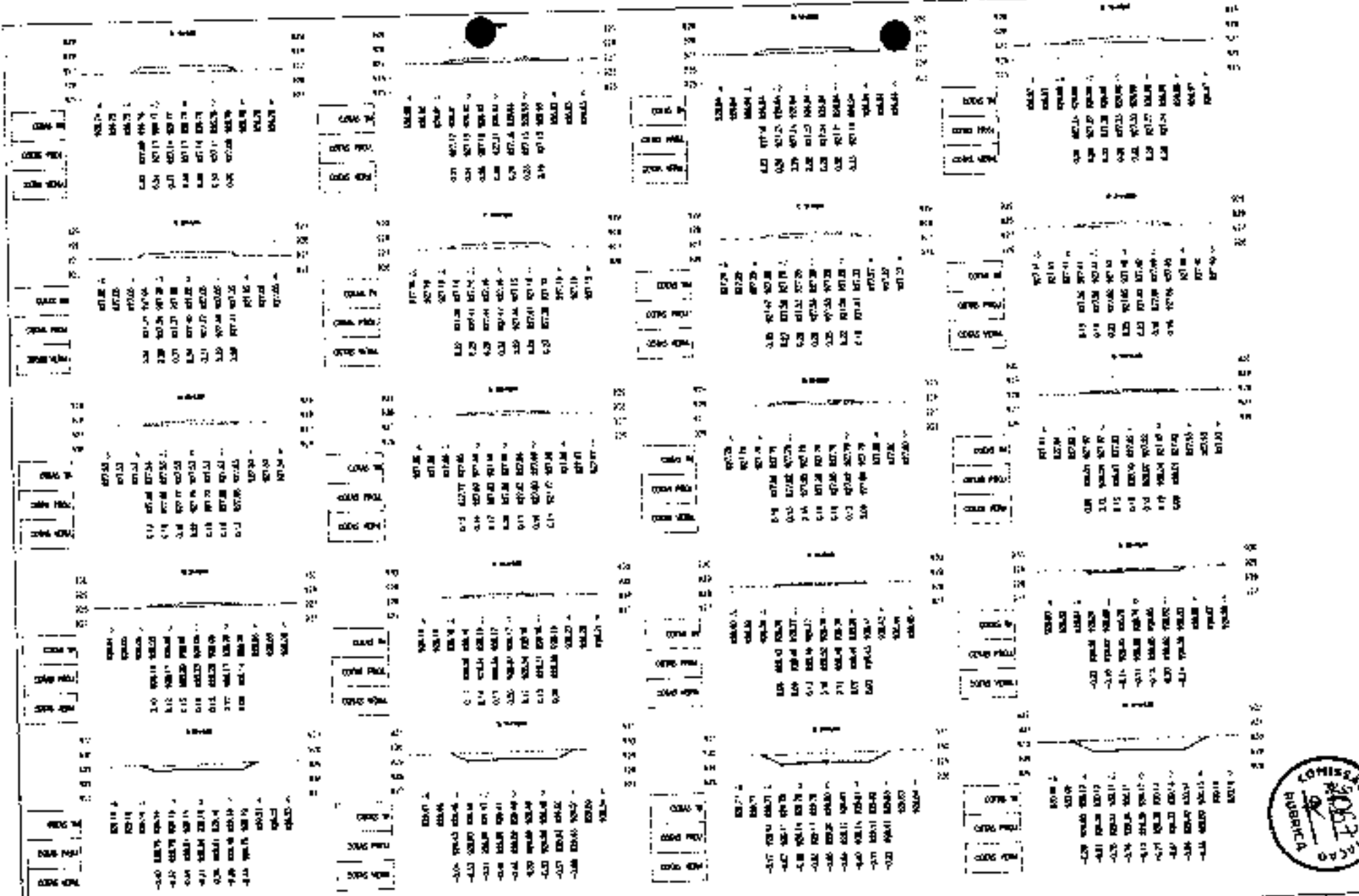

PREFEITURA MUNICIPAL DE GUARACIABA DO NORTE
RECUPERAÇÃO DE ESTRADAS VICINAIS NO MUNICÍPIO DE GUARACIABA DO NORTE-CE - PI 1086270-03
SEÇÕES TRANSVERSAIS

FOLHA
3 / 17
 ESCALA
 1:250



LEGENDA

-  ATENHO
-  CORTE

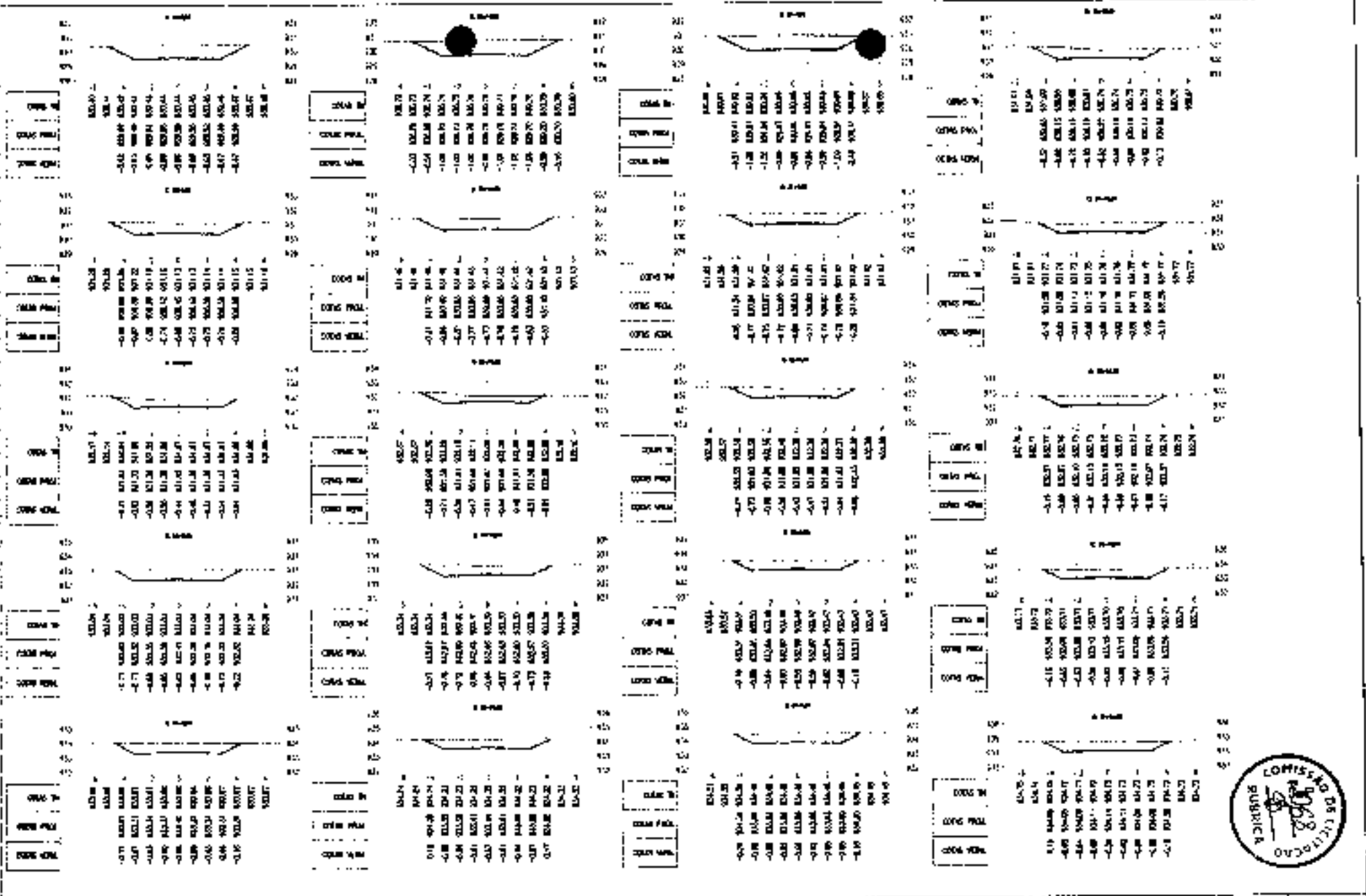



JOTA BARROS
ENGENHARIA

PREFEITURA MUNICIPAL DE GUARACIMBA DO NORTE

RECUPERAÇÃO DE ESTRADAS VICINAIS NO MUNICÍPIO DE GUARACIMBA DO NORTE - CE - PT 1006270-03

SEÇÕES TRANSVERSAIS

INSCRIÇÃO Nº

4 / 17

ESCALA

1/250



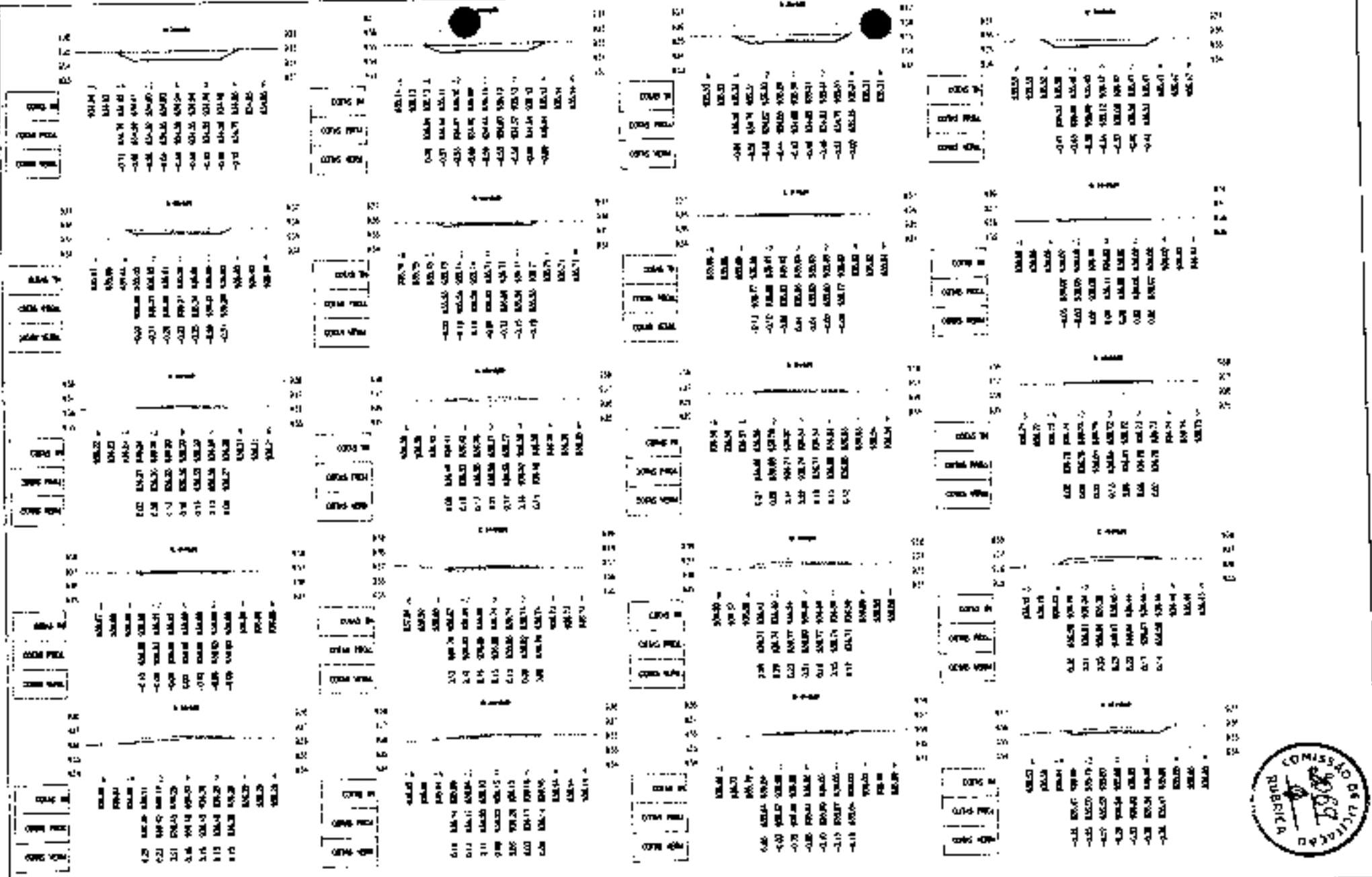

LEGENDA

- 1ª TERMO
- CORTA



PREFEITURA MUNICIPAL DE GUARACIABA DO NORTE
 RECUPERAÇÃO DE ESTRADAS VICINAIS NO MUNICÍPIO DE GUARACIABA DO NORTE-CE - PI 1066270-03

SEÇÕES TRANSVERSAIS

5 / 17
1/250



LEGENDA

- ATERRO
- CORTE

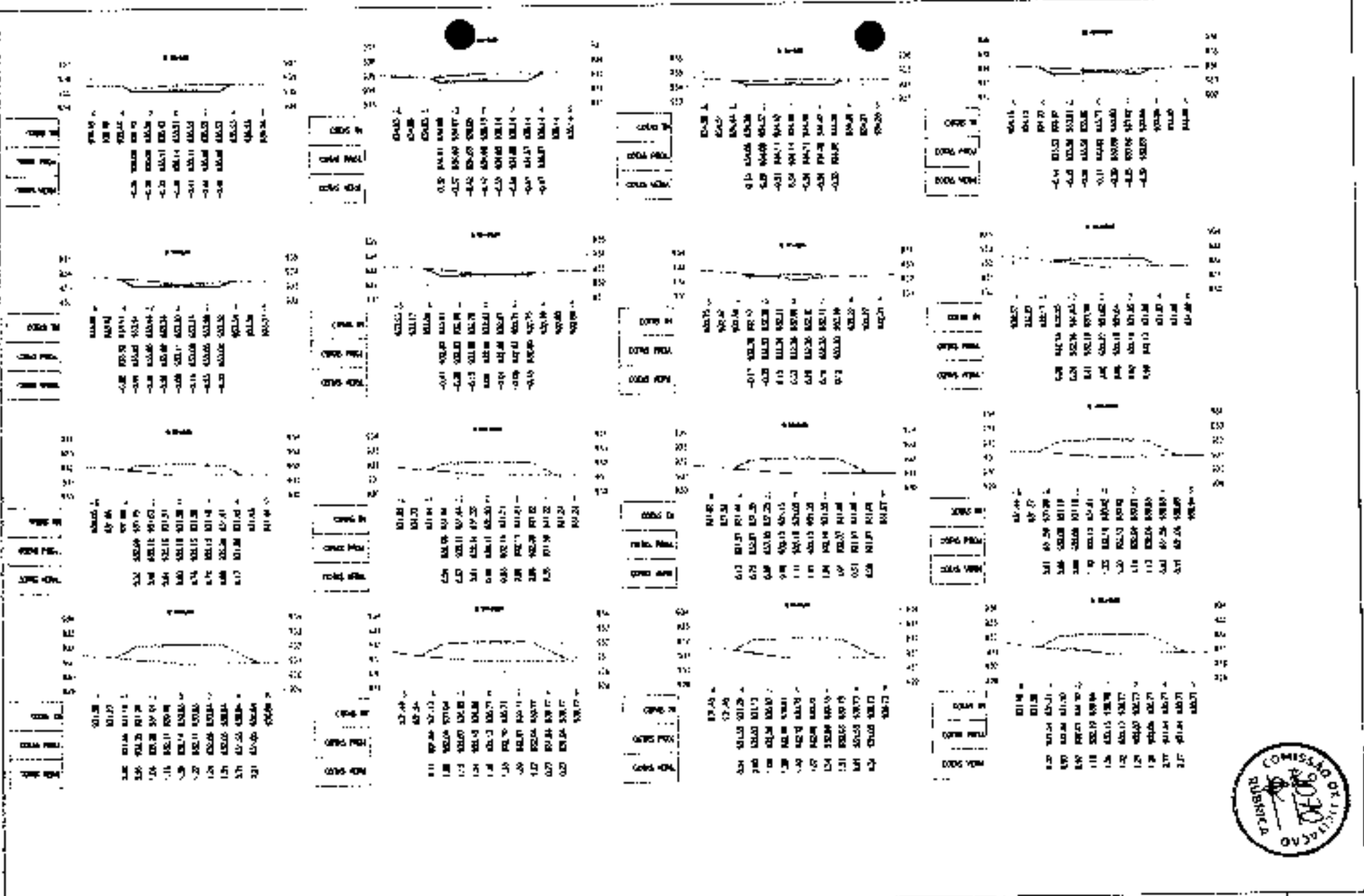

PREFEITURA MUNICIPAL DE GUARACIABA DO NORTE
 RECUPERAÇÃO DE ESTRADAS VICINAS AO MUNICÍPIO DE GUARACIABA DO NORTE-CE - PI 1266270/23
 SEÇÕES TRANSVERSAIS

PROJETO	RECUPERAÇÃO DE ESTRADAS VICINAS AO MUNICÍPIO DE GUARACIABA DO NORTE-CE - PI 1266270/23
FECHA	12/2023
ESCALA	1:250
FOLHA	5 / 17



LEGENDA

-  ATERRO
-  CORTE

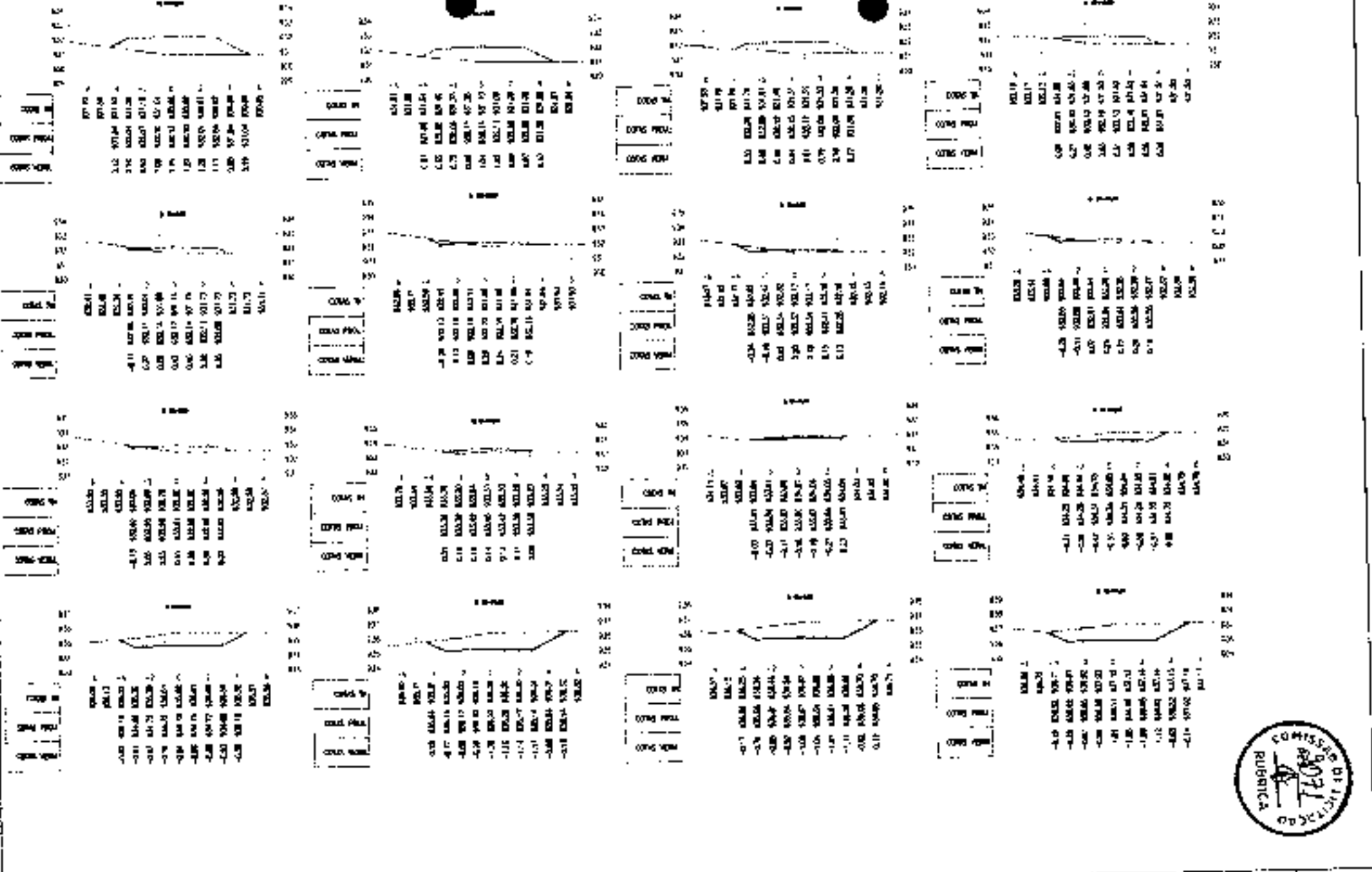

 <p>JOTA BARROS PROJETOS</p>	PREFEITURA MUNICIPAL DE GUARACIABA DO NORTE RECUPERAÇÃO DE ESTRADAS VICINAIS NO MUNICÍPIO DE GUARACIABA DO NORTE - CE - (PT: 086270-00)		Nº 7 / 17
	SEÇÕES TRANSVERSAIS		1/250
	DATA: 20/05/2014 LOCAL: GUARACIABA DO NORTE - CE		



LEGENDA:

-  ATLARO
-  CORTE

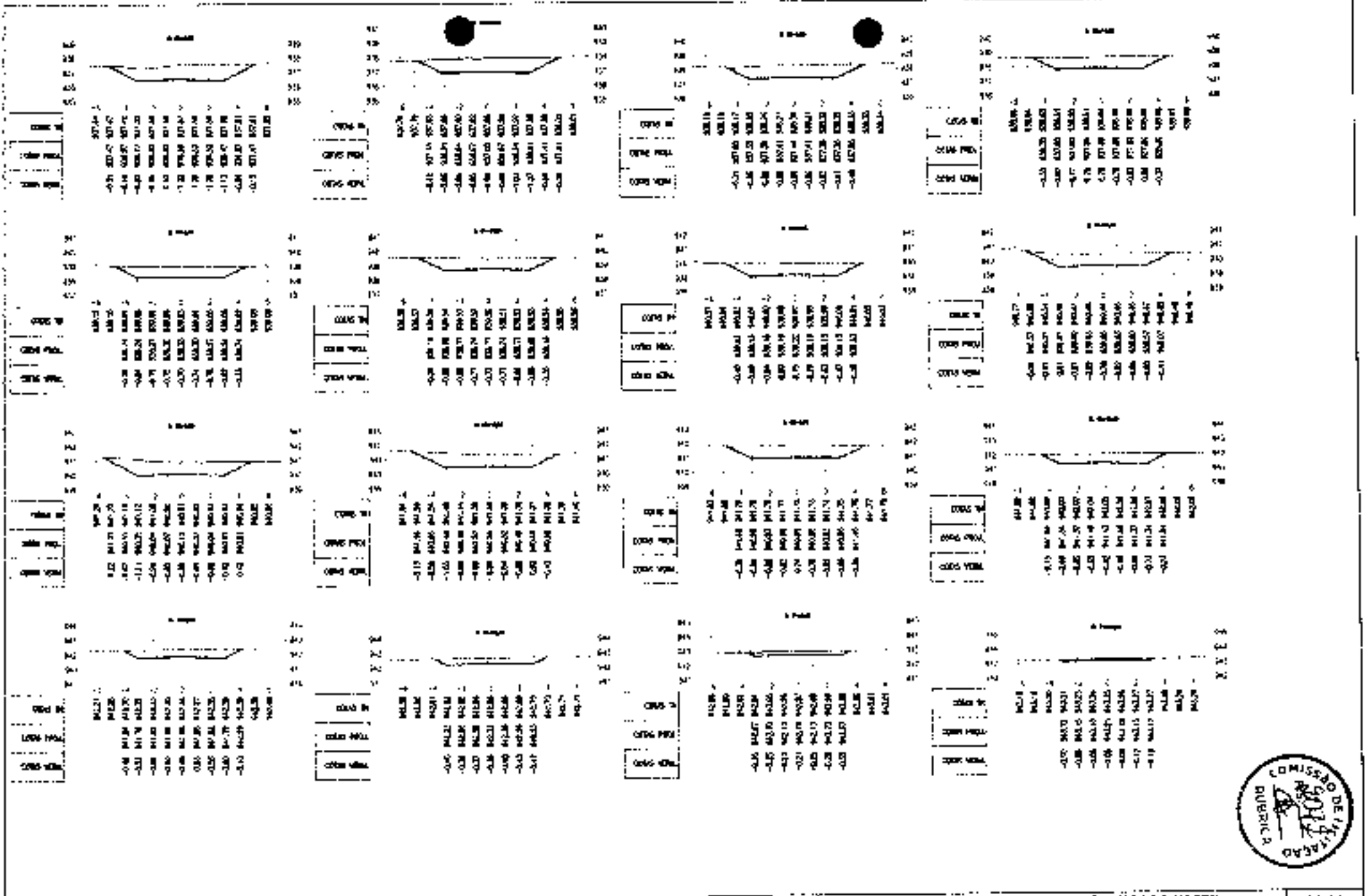

PREFEITURA MUNICIPAL DE GUARACIABA DO NORTE RECUPERAÇÃO DE ESTRADAS VICINAIS NO MUNICÍPIO DE GUARACIABA DO NORTE-CE. P.º 1085270-03	
SEÇÕES TRANSVERSAIS	
Nº Projeto:	DATA:
Nº Auto:	DATA:



LEGENDA

-  ATERRO
-  CORTE



PREFEITURA MUNICIPAL DE GUARACIABA (CO NORI)
 RECUPERAÇÃO DE ESTRADAS VICINAIS NO MUNICÍPIO DE GUARACIABA
 CO NORI - CF - PI - 086278-02
 SEÇÕES TRANSVERSAIS

FOLHA
 9 / 17
 ESCALA
 1:250

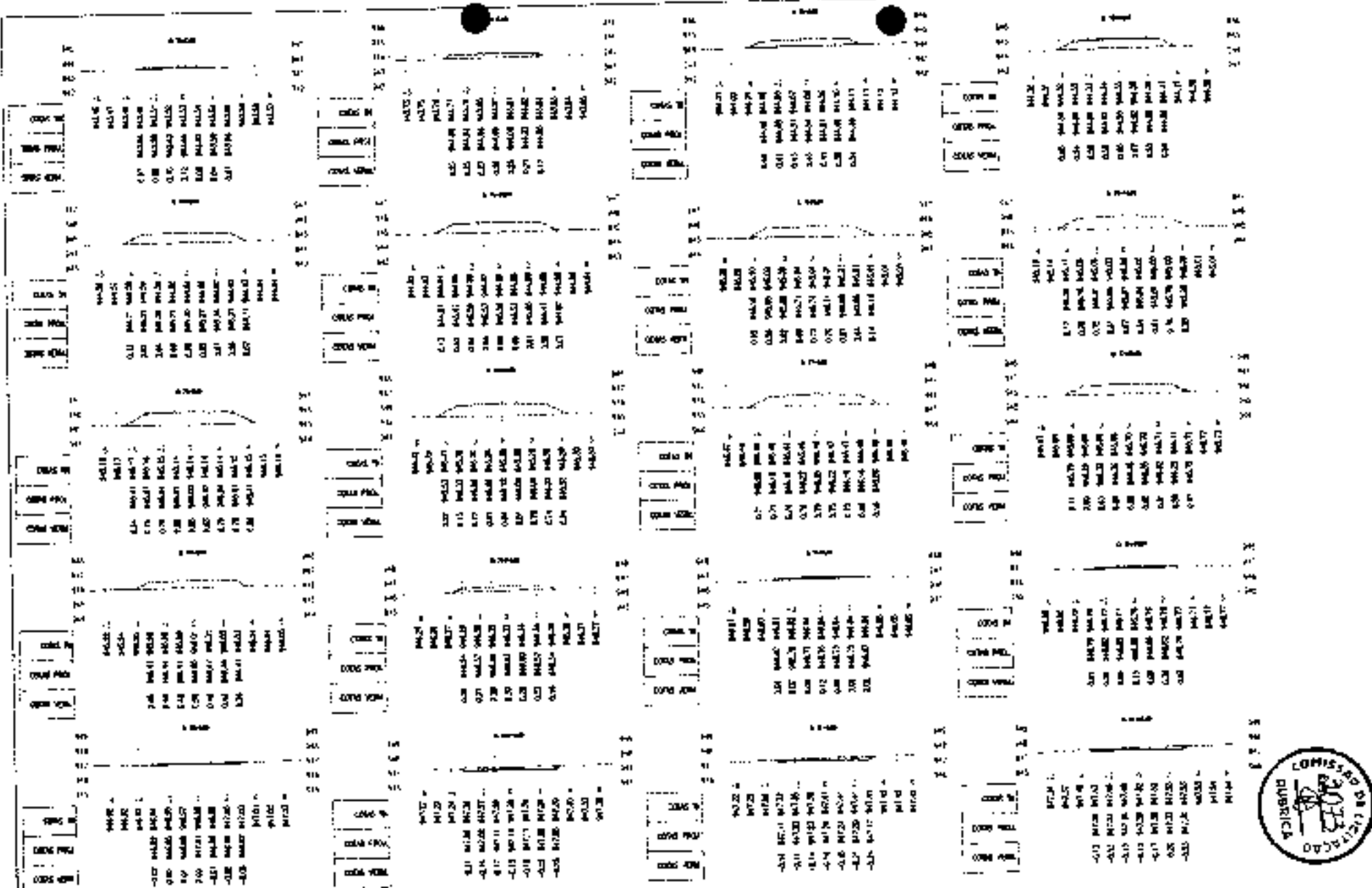

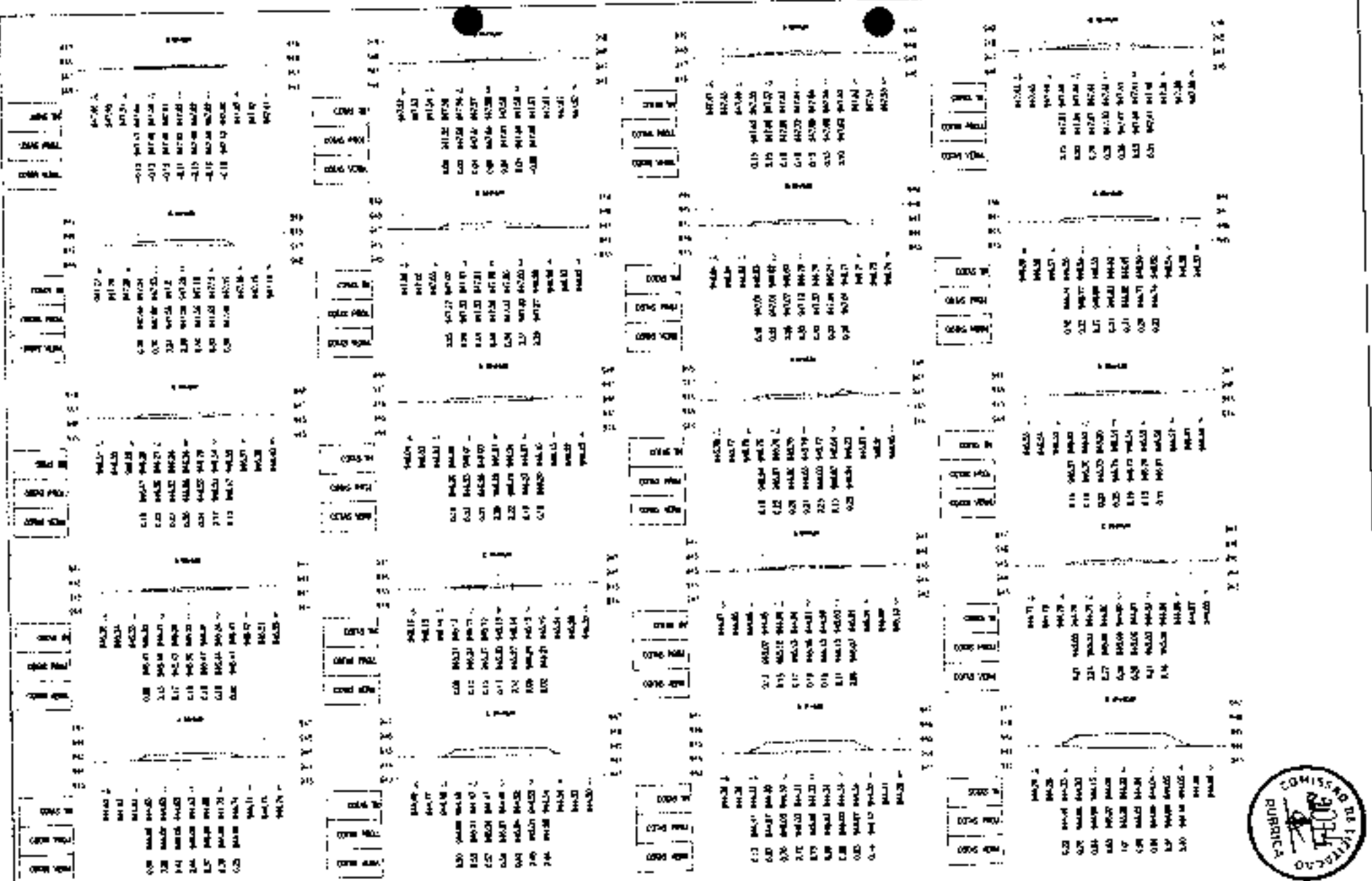

LEGENDA

ATERRO

CORTA



PREFEITURA MUNICIPAL DE GUARACIARA DO NORTE

REUPERAÇÃO DE ESTRADAS VICINAIS NO MUNICÍPIO DE GUARACIARA DO NORTE CE - PT 18862 (0-00)

SEÇÕES TRANSVERSAIS

10 / 17

1:250



LEGENDA

-  ATERRO
-  CORTA

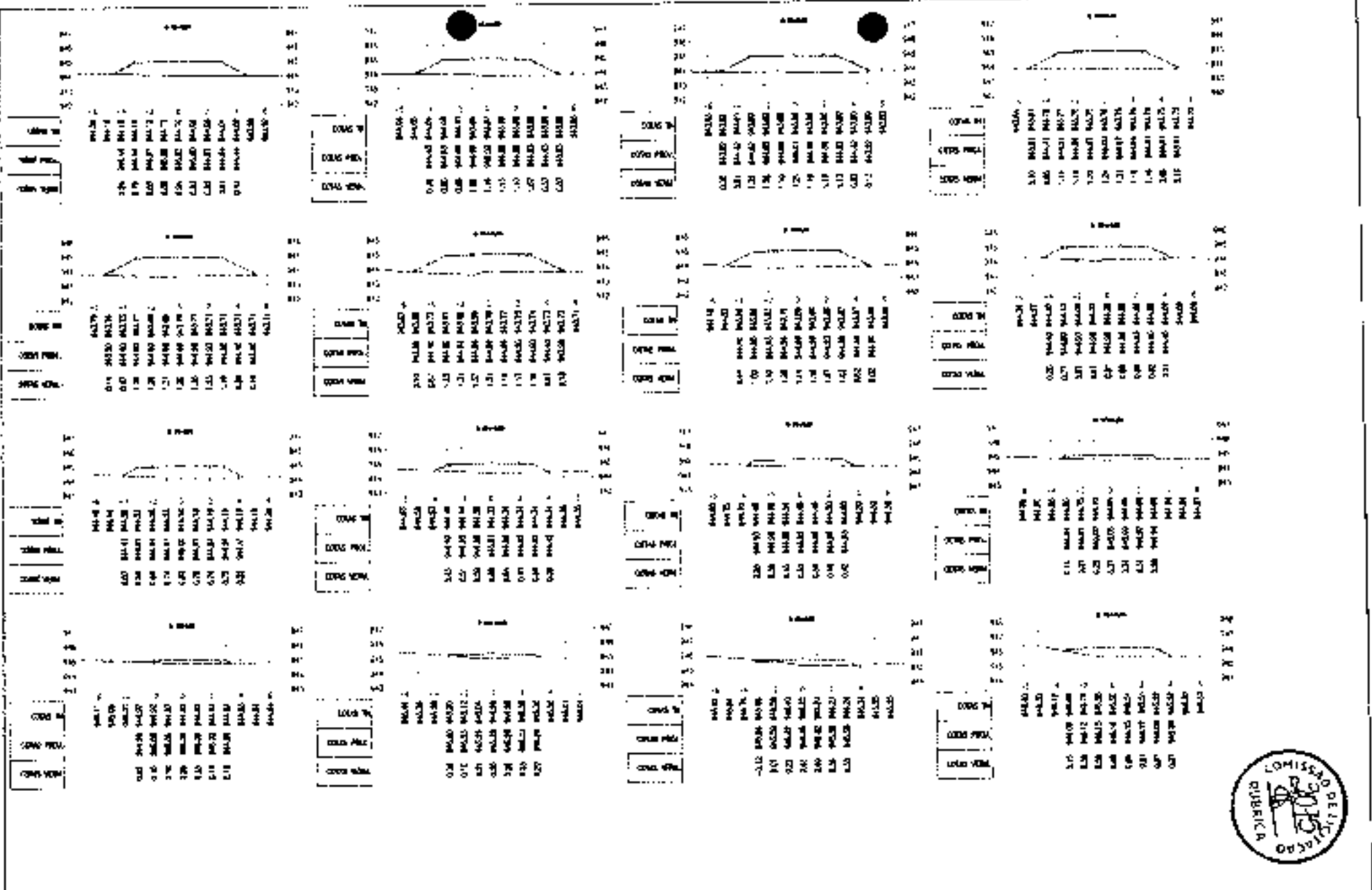



JOTA BARROS
PROJETOS

PREFEITURA MUNICIPAL DE GUARACIABA DO NORTE

RECUPERAÇÃO DE ESTRADAS VICINAIS NO MUNICÍPIO DE GUARACIABA DO NORTE-CE - PT. 008270-03

SEÇÕES TRANSVERSAIS

PROJETO Nº

DATA

ESCALA

PROJETO Nº

DATA

ESCALA

PROJETO Nº

DATA

ESCALA

PROJETO Nº

DATA

ESCALA



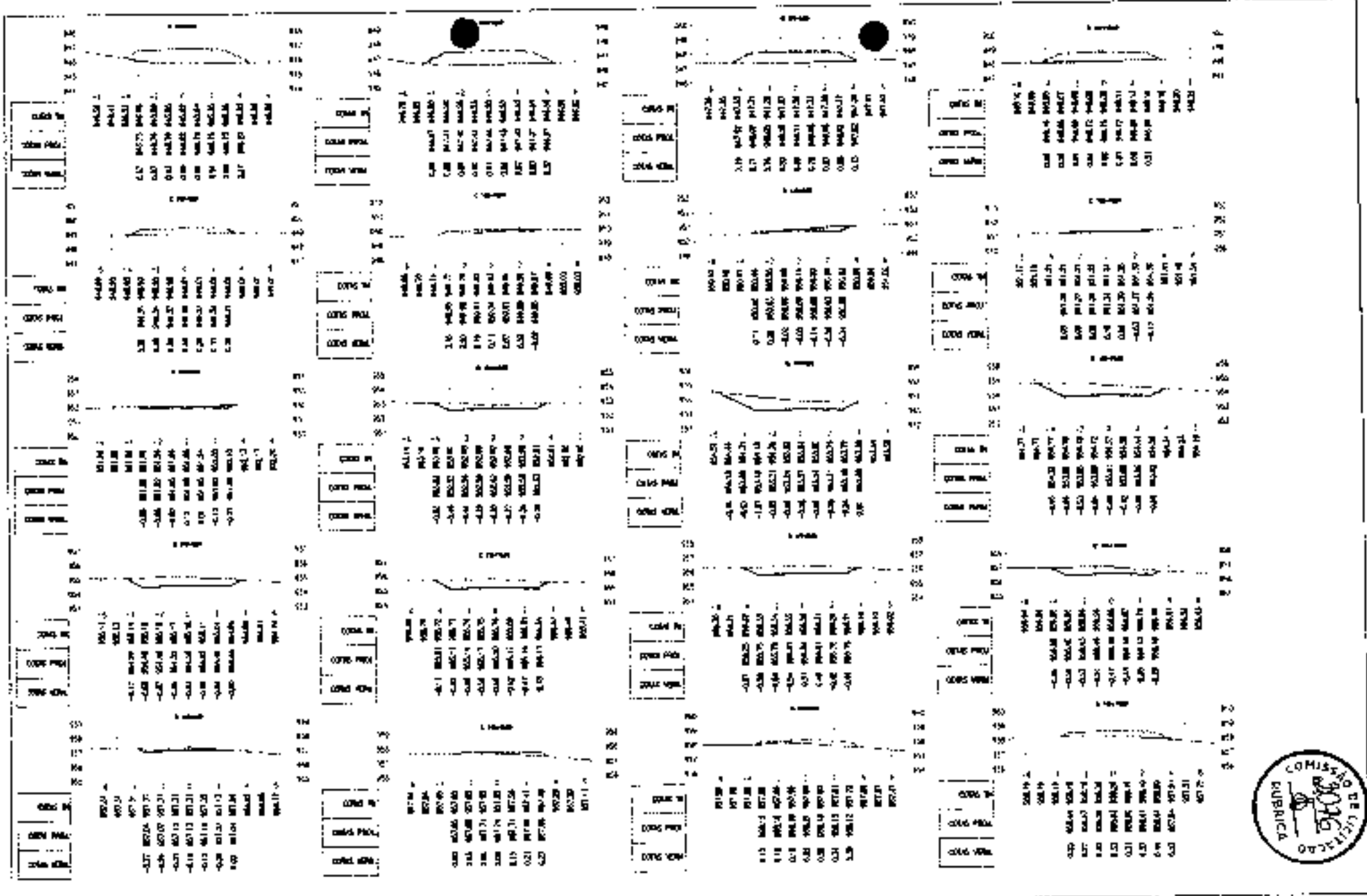

LEGENDA:





PREFEITURA MUNICIPAL DE GUARACIABA DO NORTE RECUPERAÇÃO DE ESTRADAS VICINAIS NO MUNICÍPIO DE GUARACIABA DO NORTE - P. T. 1005270-03 SEÇÕES TRANSVERSAIS	
DATA: 17/07/2011 LOCAL: GUARACIABA DO NORTE - P. T. 1005270-03	Nº: 12/17
PROJETO: RECONSTRUÇÃO DE ESTRADAS VICINAIS	Nº: 1050

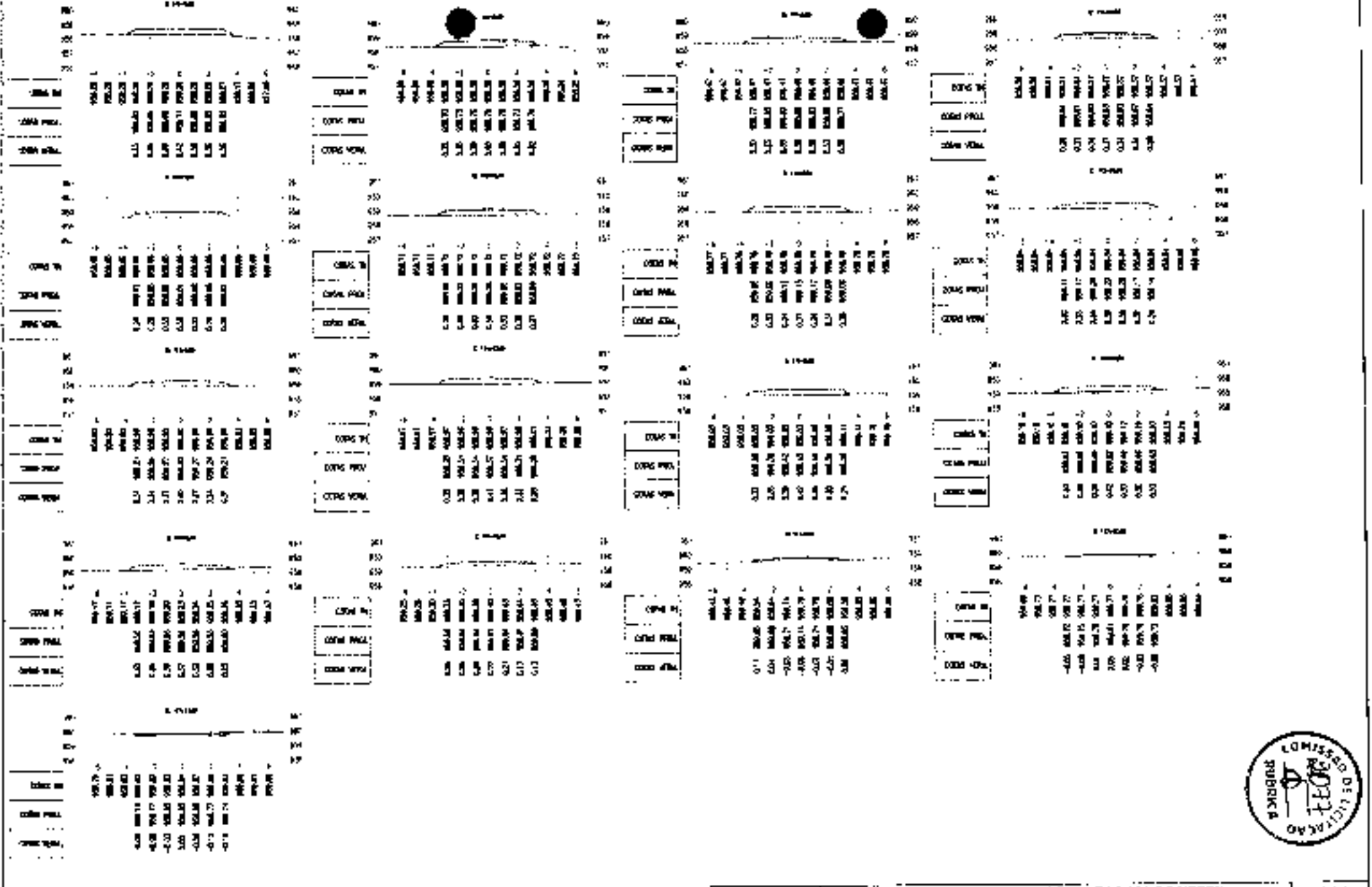

LEGENDA

-  ATERRO
-  CORTE



	PREFEITURA MUNICIPAL DE GUARACIABA DO NORTE RECLPERAÇÃO DE ESTRADAS VICINAIS NO MUNICÍPIO DE GUARACIABA DO NORTE-CE - 11 1086270-00		13 / 17
	SEÇÕES TRANSVERSAIS		1:250
	DATA: 2013		

